

UNCLASSIFIED

MCC: Status of Forces

Declassified by the Director of Marine Corps
History and Museums in accordance with the
provisions of CMO ltr Op-9420323 Joy, Ser:
10770 P942 of 12 October 1971.

P. A. Kelly 8 Mar 77
Signature/Date

UNCLASSIFIED

February 1970

Unclassified

TABLE OF CONTENTS

Feb 70

1-1	Allocation of Marine Corps Personnel	23, 25, 26, 28, 29, 35
2-1	Selected Personnel and Aircraft Data	23, 25, 29, 30, 31, 32, 34, 35
3-1	FMF Deployments & Distribution of Major Tactical Units	23, 25, 29, 30, 31, 32, 34, 35
4-1	Unit Activations & Readiness Summary	1, 3, 4, 26
4-2	USMC Reserve and 4th MEF	3, 10, 11, 17, 25
5-1	Selected Unit Commanders & Staff Officers	3, 4, 5, 17, 19, 28
6-1	USMC Reserve and 4th MEF	3, 4, 5, 17, 19, 28
7-1	Distribution of Personnel by Units, FMF Pac	3, 4, 5, 17, 19, 25, 28
8-1	Selected Unit Commanders & Staff Officers	7, 14, 17, 27
8-2	Selected Unit Commanders & Staff Officers, FMF Pac	26, 28
9-1	Location of Major Tactical Units & Distribution of Ground Weapons, FMF Pac	2, 3, 12, 13
10-1	Distribution of Aircraft by Unit and Type	3, 12
11-1	5th Marine Division Readiness Summary	10, 13, 25, 25, 26, 27, 28
14-1	M.C. Personnel in RVN (RECAP)	23, 25, 26, 27, 28, 29
15-1	WestPac Unit Locations & Strength Summary	21
16-1	Completed Phase II Deployments in Responce to JCSCM 218-66	4, 7, 9, 13, 17, 18, 21
17-1	Major RVNAF Operations in Progress	7, 13, 17, 21
18-1	Chronology of III MAF Buildup in RVN	17, 18, 21, 26, 27, 28
19-1	Major US & FWMAF Operations in Progress	7
20-1	No. of Casualties incurred by U.S. Military Personnel	3, 26
20-2	USMC/ Enemy Casualties in RVN	3
20-4	Comparative USMC/ Enemy KIA	4, 11, 12, 25
21-1	USMC Aircraft Losses in SEAsia	11, 26
22-1	Special Landing Force, 7th Fleet	
22-2	Summary of MC Amphibious Operations in South Vietnam	
24-1	Disposition of Major U.S. & FWMAF Units in RVN (Map & Recap)	16
25-1	Military Forces in RVN (Strength Recap)	6
26-1	U.S. Army Tactical Units in RVN	11, 24
26-2	General Officers & Commanders of Major Units etc.	23, 27, 10, 16, 19, 20, 21, 28
26-3	Units in Vietnam	7, 17, 27
27-1	U.S. Air Force Units in Vietnam	
28-1	U.S. Navy Forces in I CTZ, SEAsia, & WestPac	
29-1	Republic of Korea & Republic of Vietnam Marine Corps	
30-1	Chronology of Significant Events in RVN	
31-1	Disposition/Missions of ARVN Bns in I CTZ	
32	FMF Pac Unit Locations & Strengths (MIDPAC/EASTPAC)	
32-1	Confirmed NVA/VC OB by GVN Tactical Zone	
32-4	Enemy Order of Battle/General Operating Areas	
33-1	Intelligence Estimate I CTZ	
34-1	Maps - RVN & DRV	
35-1	Vietnam General Reference Data	
39-1	Distribution of Personnel by Units, FMF Lant	
40-1	Selected Unit Commanders & Staff Officers, FMF Lant	
41-1	Distribution of Aircraft & Ground Weapons, FMF Lant	
42-1	Landing Force Mediterranean & Caribbean Ready Force	
43-1	FMF Lant Readiness Summary	

Unclassified

UNCLASSIFIED

SUMMARY OF MAJOR US AND FWMAF OPERATIONS

OPERATION (DATE COMMENCED)	UNITS INVOLVED	LOCATION	CASUALTIES AS OF: 012400H FEB70		
			FRIENDLY		ENEMY
			KIA	WIA	KIA
GREEN RIVER (19JAN70)	1ST BDE, 5TH INF DIV (MECH): 4 USA BNS	EASTERN QUANG TRI PROVINCE	1	52	21
RANDOLPH GLEN (7DEC69)	101ST ABN DIV (AM): 9 USA BNS	QUANG TRI & THUA THIEN PROVINCES	39	214	310
VICTORY DRAGON XIX (1JAN70)	2D ROKMC BDE: 3 BNS	HOI AN AREA	NONE	9	8
VICTORY DRAGON XIX-1 (25JAN70)	2ND ROKMC BDE: 1 BN	HOI AN AREA	NONE	3	25
FREDERICK HILL (18MAR69)	196TH INF BDE: 3 USA BNS	QUANG TIN PROVINCE	362	2,264	4,362
GENEVA PARK (18JUL69)	198TH INF BDE: 2 USA BNS	QUANG TIN & QUANG NGAI PROVINCES	124	838	1,105
NANTUCKET BEACH (20JUL69)	198TH INF BDE: 1 USA BN	CENTERED 15 KM NE OF QUANG NGAI CITY	23	197	237
IRON MOUNTAIN (18MAR69)	11TH INF BDE: 5 USA BNS	QUANG NGAI PROVINCE	*285	1,647	2,416

* - ADJUSTED
- FINAL CUMULATIVE CASUALTIES

Unclassified
UNCLASSIFIED

MARINE CORPS COMMAND CENTER

SELECTED PERSONNEL AND AIRCRAFT DATA

UNCLASSIFIED

PERSONNEL

2 FEBRUARY 1970

	STRENGTH	PERCENT USMC	PERCENT FMF	PERCENT FMFPAC
USMC TOTAL	300,982 *	100.00		
FLEET MARINE FORCES	153,954	51.15	100.00	
FMF ATLANTIC	42,404 \$	15.26	27.54	
FMF PACIFIC	108,033 #	35.89	70.17	
VIETNAM	55,503 ¢	18.44	36.05	51.37

SOURCE: * MONTHLY USMC PERSONNEL ALLOCATION REPORT OF 30NOV69.
 \$ MCCC UNIT REPORT OF 24DEC69.
 # MCCC UNIT REPORT OF 21JAN70.
 ¢ MACV WEEKLY STRENGTH REPORT AS OF 2400, 15JAN70 AS ADJUSTED BY MACV REPORT OF ARR/DEPART AS OF 2400, 31JAN70.

AIRCRAFT

10 JANUARY 1970

	FIXW	HELO	TOTAL	PERCENT USMC	PERCENT FMF	PERCENT FMFPAC
USMC TOTALS	1013	569	1582	100.00		
FLEET MARINE FORCES	768	547	1315	83.12	100.00	
FMF ATLANTIC	303	156	459	29.01	34.90	
FMF PACIFIC	465	391	856	54.11	65.10	
VIETNAM	197	195	392	24.78	29.81	45.79

SOURCE: MARINE CORPS COMMAND CENTER UNIT REPORT OF 31DEC69.

UNCLASSIFIED

Unclassified

~~CONFIDENTIAL~~

MARINE CORPS COMMAND CENTER

FLEET MARINE FORCE DEPLOYMENTS

2 FEBRUARY 1970

UNCLASSIFIED

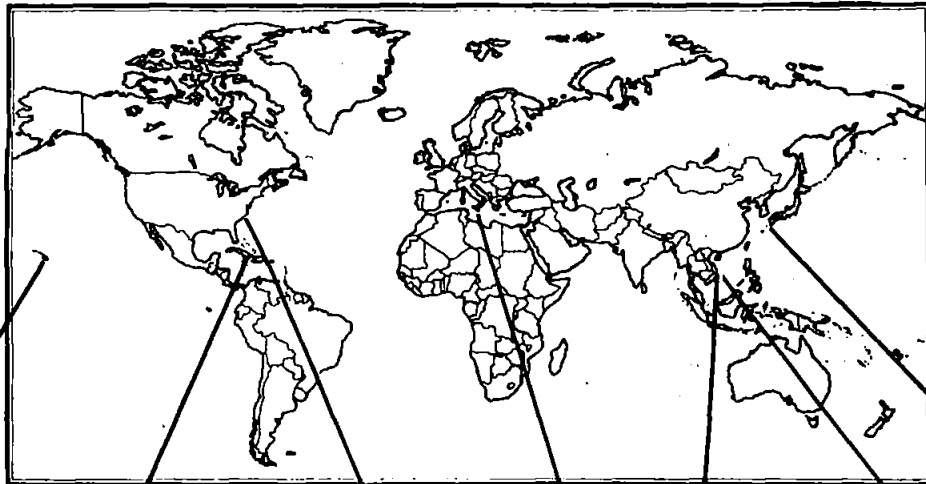

1ST MAR BRIG
HAWAII

GTMO AUGMENT
 2D BN, 8TH MAR
 BTRY B/1/10
 PLT 2D TK BN
 PLT 2D ANGLICO
 DET FSR

LANFORCARIB 1-70
 BLT 3/2 & HMM-261
 AT ROOSEVELT ROADS

LANFOR6THFLT 3-69
 AT NAPLES
 ETD: 7 FEB 70

III MAR
 RVN

SLF, 7TH FLEET
SLF BRAVO
 EMBARKED ABOARD ARG
 AND TO REMAIN IN PORT
 AT SUBIC BAY.

I MEF
 OKINAWA
 & JAPAN
 B/1/4 & 2D PLAT/B/3D
 TK BN AT FUJI FOR
 TRAINING.

SLF ALFA
 AT OKINAWA

DISTRIBUTION OF MAJOR FMF UNITS

	INF BNS	VMFA	VMA	VMA(AW)	VMCJ	AVMA	AVMB	HML	VMG	VMGR
WESTPAC	18	6	3	3	1	6	3	2	2	1
RVN	(12)	(4)	(3)	(2)	(1)	(4)	(2)	(2)	(1)	
OKINAWA/JAPAN	(4)	(2)		(1)			(1)		(1)	(1)
ASSIGNED TO SLF's	(2)					(2)				
MIDPAC	1	2								
HAWAII	(1)	(2)								
AFLOAT										
EASTPAC	2	2	1		1	2	1	1		1
WEST COAST	(2)	(2)	(1)		(1)	(2)	(1)	(1)		(1)
AFLOAT										
ATLANTIC	8	5	2	3	1	4	2		1	1
EAST COAST	(6)	(5)	(2)	(3)	(1)	(3)	(2)		(1)	(1)
CARIBBEAN	(2)					(1)				
EUROPE	1									
MEDITERRANEAN	(1)									
GRAND TOTAL	30	15	6	6	3	12	6	3	3	3

Unclassified

UNCLASSIFIED

~~SECRET~~

MARINE CORPS COMMAND CENTER

MARINE CORPS PERSONNEL IN RVN

UNCLASSIFIED

2 FEBRUARY 1970

	OFF	ENL	TOTAL
* III MAF.	3,727	51,464	55,191
DANANG	(3,169)	(44,618)	(47,787)
CHU LAI	(395)	(4,888)	(5,283)
PHU BAI	(126)	(1,211)	(1,337)
DONG HA	(37)	(747)	(784)
SU #1, 1ST ANGLICO (AT VARIOUS LOCATIONS SVN)	((22))	((192))	((214))
OTHER USMC PERSONNEL	160	152	312
MACV STAFF/MACV FIELD	(136)	(139)	(275)
NAVAIDVGRU/NAVY UNITS	(24)	(13)	(37)
USMC IN RVN CHARGED AGAINST PROGRAM VIII	3,887	51,616	55,503
U. S. NAVY, III MAF.	267	1,916	2,183

* AS REPORTED BY III MAF DAILY ADMIN SITREP # 0028 AS OF 2400, 27 JAN 70 AND ADJUSTED IN ACCORDANCE WITH MACV WEEKLY STRENGTH REPORT AND DAILY MACV REPORTS OF ARRIVALS/DEPARTURES AS OF 2400, 31 JAN 70.

Unclassified

UNCLASSIFIED

~~SECRET~~

~~SECRET~~

WESTPAC UNIT LOCATIONS

2 FEBRUARY 1970

UNCLASSIFIED

QUANG TRI		USMC	784
(QUANG TRI CITY)		USN	39 *
		USA	5,800
1ST BDE, 5TH INF DIV (MECH) 1/77 ARMOR (OPN GREEN RIVER) 1/61 INF (MECH) (OPN GREEN RIVER) 1/11 INF (OPN GREEN RIVER) 3/5 ARMD CAV SQDN (OPN GREEN RIVER)			
THUA THIEN		USMC	1,337
HQ, XXIV CORPS (PHU BAI)		USN	44 *
HQ, 101st ABN DIV (AM)		USA	26,050
1ST BDE, 101ST ABN DIV (AM) 1/327 INF (AM) (OPN RANDOLPH GLEN) 2/327 INF (AM) (OPN RANDOLPH GLEN) 2/502 INF (AM) (OPN RANDOLPH GLEN) 2D BDE, 101ST ABN DIV (AM) 1/501 INF (AM) (OPN RANDOLPH GLEN) 2/506 INF (AM) (OPN RANDOLPH GLEN) 1/502 INF (AM) (OPN RANDOLPH GLEN) 3D BDE, 101ST ABN DIV (AM) 1/506 INF (AM) (OPN RANDOLPH GLEN) 2/506 INF (AM) (OPN RANDOLPH GLEN) 3/187 INF (AM) (OPN RANDOLPH GLEN)			
QUANG NAM		USMC	47,787
HQS, III MAF		USN	1,970 *
HQS 1ST MAR DIV (DANANG)		USA	1,058
1ST MARINES 1/1 2/1 3/1 5TH MARINES 1/5 2/5 3/5 7TH MARINES 1/7 2/7 3/7 26TH MARINES 1/26 2/26 3/26			
HOS, III MAF		USMC	47,787
HOS 1ST MAR DIV (DANANG)		USN	1,970 *
HOS 1ST MAR DIV (DANANG)		USA	1,058
HO 1st MAW MAG-11 VMFA-542 (F-4B) VMA(AW)-242 (A-6A) VMA(AW)-225 (A-6A) VMCJ-1 (RF-4/EA-6/EF-10) MAG-16 (-) VMO-6 (UH/1E/OV-10A/AH-1G) HMH-361 (CH-53A) HML-167 (UH-1E) HMH-463 (CH-53A) HMM-364 (CH-46D) HMM-263 (CH-46D)			
2d ROKMC BDE 1/2 (OPN VICTORY DRAGON XIX-1) 2/2 (OPN VICTORY DRAGON XIX) 3/2 (OPN VICTORY DRAGON XIX) 5/2 (OPN VICTORY DRAGON XIX)			
FLC 1ST FSR/FLSG-B/1ST SERV BN		USMC	5,283
QUANG TIN/QUANG NGAI		USN	130 *
HQ 23d INF DIV (AMERICAL) (CHU LAI)		USA	24,106
196TH LT INF BDE 2/1 INF (OPN FREDERICK HILL) 4/31 INF (OPN FREDERICK HILL) 3/21 INF (OPN FREDERICK HILL) 1/46 INF 198TH LT INF BDE 1/6 INF (OPN GENEVA PARK) 1/52 INF (OPN GENEVA PARK) 5/46 INF (OPN NANTUCKET BEACH) 11TH INF BDE 1/20 INF (OPN IRON MOUNTAIN) 4/21 INF (OPN IRON MOUNTAIN) 3/1 INF (OPN IRON MOUNTAIN) 4/3 INF (OPN IRON MOUNTAIN) 1/1 ARMD CAV SQDN (OPN IRON MOUNTAIN)			
HQ, I MEF		USMC	19,200
3D MARDIV (-) (REIN)		USN	934
OSD PROGRAM VIII CEILING ACTUALS CHARGED AGAINST PROGRAM VIII AS OF 15JAN70. 18,255 424 4TH MARINES 9TH MARINES 1/4 3/9 2/4 3/4 MAG-36 (13,989) (349) VMGR-152 (KC-130F) VMO-6 (OV-10A) HMH-462 (CH-53A)			
3D FSR		(3,175)	(50)
MCB CAMP BUTLER/NON FMF		(920)	(25)
Non-Deployable Casuals		(171)	
SVN-Originated Patients		(0)	
OKINAWA		USMC	19,200
HQ, I MEF		USN	934
3D MARDIV (-) (REIN)		USA	24,106
OSD PROGRAM VIII CEILING ACTUALS CHARGED AGAINST PROGRAM VIII AS OF 15JAN70. 18,255 424 4TH MARINES 9TH MARINES 1/4 3/9 2/4 3/4 MAG-36 (13,989) (349) VMGR-152 (KC-130F) VMO-6 (OV-10A) HMH-462 (CH-53A)			
3D FSR		(3,175)	(50)
MCB CAMP BUTLER/NON FMF		(920)	(25)
Non-Deployable Casuals		(171)	
SVN-Originated Patients		(0)	
USMC RVN RECAP		USMC	USN
OSD PROGRAM VIII CEILING		55,510	2,233
ACTUALS CHARGED AGAINST PROGRAM VIII AS OF 31JAN70.		55,503	2,183
III MAF		55,191	2,183
SU#1, 1ST ANGLICO		((214))	((14))
MACV STF/MACV FLD		(275)	
NAVADVGRU/NAVY UNITS		(37)	
I CORPS RECAP			
US MARINE CORPS . . . (12 BNs)		55,191	
US ARMY (25 BNs)		73,849	
US NAVY		17,097	
US AIR FORCE		8,194	
ROKMC (4 BNs)		7,145	
RVNAF (36 BNs)		149,640	
ARVN/ABN (36 BNs)		(73,607)	
VNMC			(2,092)
VNN			(3,416)
VNAF			(36,339)
VNRF			(34,186)
VNPF			
I CORPS TOTAL		77 BNs	311,125
SLF 7TH FLEET		USMC	USN
BRAVO: BLT 2/9		1,847	60
HMM-165			
AT SUBIC			
EMBARKED ABOARD ARG AND TO REMAIN IN FORT			
ALFA: BLT 1/9		1,868	85
HMM-164			
AT OKINAWA			
MOVEMENTS			
B/1/4 & 2D Plat/B/3D Tk Bn at Fuji for training.			
Det 12TH MAR and "D" Co, 3D Recon at Namazu.			
JAPAN		USMC	USN
OSD PROGRAM VIII CEILING		3,600	45
ACTUALS CHARGED AGAINST PROGRAM VIII AS OF 15JAN70.		3,455*	34
1ST MAW (REAR)		(2,244)	(34)
MAG-15			
VMFA-232 (F-4J)			
VMFA-334 (F-4J)			
VMA(AW)-533 (A-6A)			
*Does NOT include 295 hospitalized SVN-Originated Patients.			
Non FMF		(1,211)	

* Includes only U. S. Navy Personnel organic to FMF Units.
 # Includes SU#1 and 1st ANGLICO at various locations throughout SVN.
 • Latest Change

UNCLASSIFIED

MARINE CORPS

FEB 2 1970

REFERENCE BRANCH

Unclassified

~~SECRET~~

2 FEBRUARY 1970

MAJOR RVNAF OPERATIONS IN PROGRESS

UNCLASSIFIED

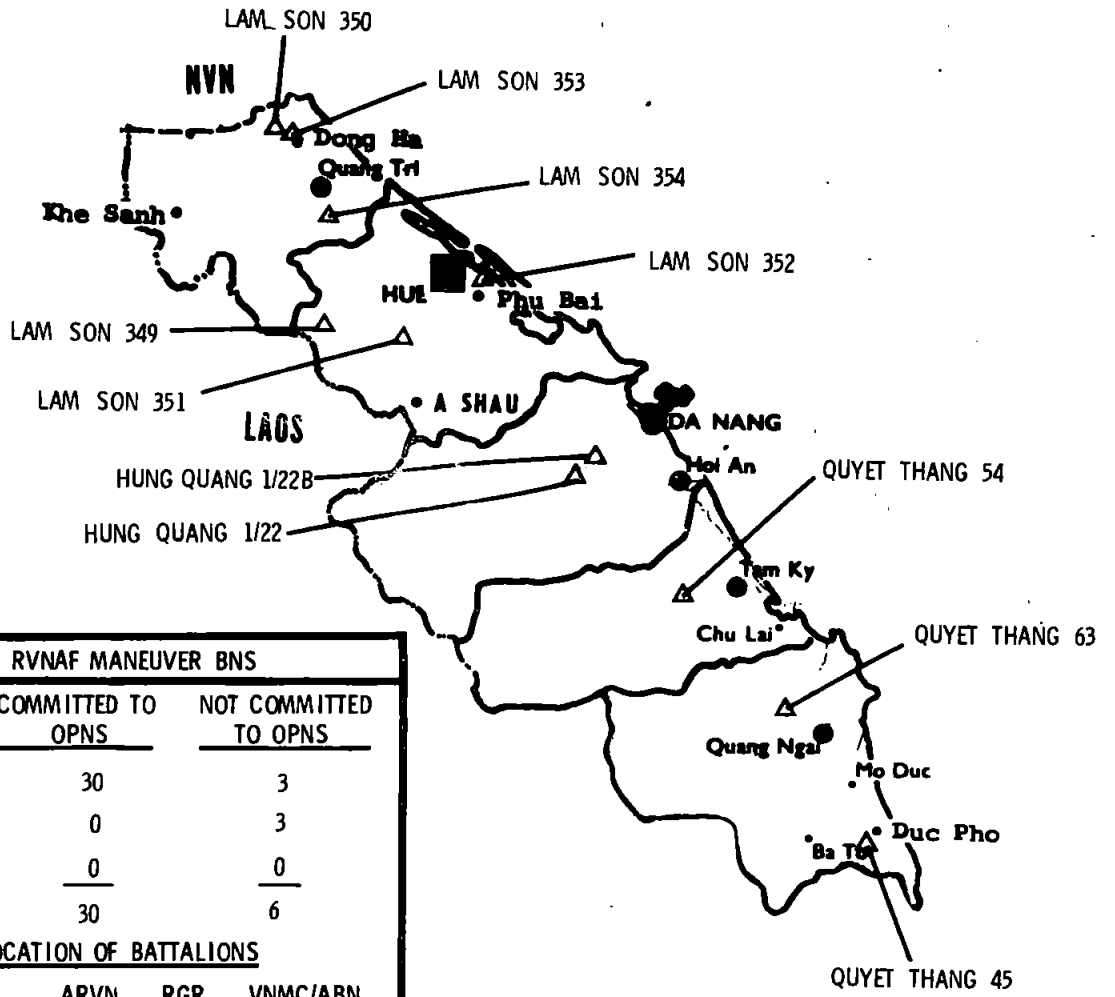

I CTZ RVNAF MANEUVER BNS			
TOTAL BNS	COMMITTED TO OPNS	NOT COMMITTED TO OPNS	
ARVN	33	30	3
RANGER	3	0	3
VNMC/ABN	0	0	0
	36	30	6
LOCATION OF BATTALIONS			
	ARVN	RGR	VNMC/ABN
QUANG TRI	6	0	0
THUA THIEN	11	0	0
QUANG NAM	5	1	0
QUANG TIN	3	2	0
QUANG NGAI	8	0	0

17-1

~~SECRET~~

UNCLASSIFIED

Unclassified

UNCLASSIFIED

SUMMARY OF MAJOR RVNAF OPERATIONS

OPERATION (DATE COMMENCED)	UNITS INVOLVED	LOCATION	CASUALTIES AS OF: 022400H FEB70		
			FRIENDLY		ENEMY
			KIA	WIA	KIA
LAM SON 350 (1JAN70)	2ND REGT: 1/2, 3/2, 4/2 & 5/2	5 KM E OF GIO LINH	15	64	*139
LAM SON 353 (1JAN70)	7TH CAV: 3/7 CAV & 2/2	5 KM SE OF GIO LINH	6	33	14
LAM SON 354 (6JAN70)	54TH REGT: 3/54	6 KM S OF QUANG TRI CITY	1	NONE	NONE
LAM SON 352 (1JAN70)	54TH REGT: 1/54, 2/54 & 4/54	2 KM NW OF PHU BAI	1	NONE	20
LAM SON 349 (1JAN70)	1ST REGT: 1/1, 2/1, 3/1 & 4/1	21 KM NW OF A LUOI	7	*32	*98
LAM SON 351 (1JAN70)	3RD REGT: 1/3, 2/3, 3/3 & 4/3	25 KM SW OF HUE	4	17	29
HUNG QUANG 1/22 (12JAN70)	51ST REGT: 1/51	16 KM NW OF HOI AN	NONE	*5	NONE
HUNG QUANG 1/22B (31JAN70) (TERM: 011200H)	51ST REGT: 4/51	22 KM NNE OF AN HOA	# 1	# 2	#NONE
QUYET THANG 54 (2JAN70)	5TH REGT: 1/5, 2/5, 4/5, 2/6 & 4/6	12 KM W OF TAM KY	19	50	99
QUYET THANG 63 (2JAN70)	6TH REGT: 3/6	18 KM NW OF QUANG NGAI CITY	15	*82	71
QUYET THANG 45 (4JAN70)	4TH REGT: 1/4, 2/4, 3/4 & 4/4	11 KM SW OF DUC PHO	*15	*40	*205

ALL UNITS ARE ARVN UNLESS DESIGNATED
 * - ADJUSTED
 # - FINAL CUMULATIVE CASUALTIES

UNCLASSIFIED

~~UNCLASSIFIED~~
UNCLASSIFIED

SUMMARY OF MAJOR US AND FWMAF OPERATIONS

OPERATION (DATE COMMENCED)	UNITS INVOLVED	LOCATION	CASUALTIES AS OF: 022400H FEB70		
			FRIENDLY		ENEMY
			KIA	WIA	KIA.
GREEN RIVER (19JAN70)	1ST BDE, 5TH INF DIV (MECH): 4 USA BNS	EASTERN QUANG TRI PROVINCE	2	54	23
RANDOLPH GLEN (7DEC69)	101ST ABN DIV (AM): 9 USA BNS	QUANG TRI & THUA THIEN PROVINCES	39	216	314
VICTORY DRAGON XIX (1JAN70)	2D ROKMC BDE: 2 BNS	HOI AN AREA	NONE	9	8
VICTORY DRAGON XIX-1 (25JAN70)	2D ROKMC BDE: 1 BN	HOI AN AREA	NONE	*7	*31
VICTORY DRAGON XIX-21 (31JAN70)	2D ROKMC BDE: 1 BN	HOI AN AREA	NONE	NONE	1
FREDERICK HILL (18MAR69)	196TH INF BDE: 3 USA BNS	QUANG TIN PROVINCE	362	*2,271	*4,372
GENEVA PARK (18JUL69)	198TH INF BDE: 2 USA BNS	QUANG TIN & QUANG NGAI PROVINCES	124	839	1,109
NANTUCKET BEACH (20JUL69)	198TH INF BDE: 1 USA BN	CENTERED 15 KM NE OF QUANG NGAI CITY	23	197	238
IRON MOUNTAIN (18MAR69)	11TH INF BDE: 5 USA BNS	QUANG NGAI PROVINCE	286	*1,622	2,418

* - ADJUSTED
- FINAL CUMULATIVE CASUALTIES

~~UNCLASSIFIED~~
UNCLASSIFIED

Unclassified

~~UNCLASSIFIED~~

MARINE CORPS COMMAND CENTER

USMC/ENEMY CASUALTIES IN RVN

2 FEBRUARY 1970

USMC BATTLE CASUALTIES

KIA/DOW	WIA(EVAC)	WIA(RTD)	MIA/PW
12,410	48,656	35,696	83/21

USMC CASUALTY FIGURES ARE PROVIDED DAILY BY HQMC CASUALTY SECTION (CODE DNA) AND REFLECT ALL CASUALTIES REPORTED AS OF 30JAN70.

USMC NON-BATTLE CASUALTIES

DEAD	INJURED	MISSING
1,497	1,818	8

FIGURES INDICATED AS INJURED ARE ONLY THOSE IN SERIOUS/CRITICAL INJURY OR DISEASE CATEGORY AND DO NOT INCLUDE THOSE OF A MINOR NATURE

USMC INFLICTED ENEMY CASUALTIES

KIA	PW	WPNS
80,107	4,113	20,616

ENEMY CASUALTIES ARE COMPILED DAILY FROM THE III MAF HISSUM AND ARE RECONCILED MONTHLY WITH THE FMFPAC SUMMARY OF USMC OPERATIONS IN RVN

TYPICAL DISPOSITION OF 100 USMC WIA *

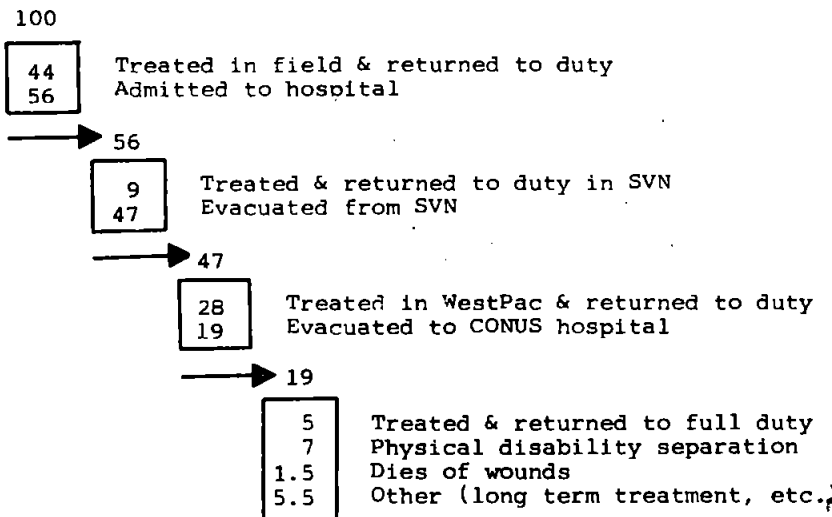

*54,081 CASUALTIES, JAN67-DEC68.

Unclassified

~~UNCLASSIFIED~~

UNCLASSIFIED
CONFIDENTIAL

MARINE CORPS COMMAND CENTER

MILITARY FORCES IN RVN *

2 FEBRUARY 1970

RVN ARMED FORCES (RVNAF)

ARMY (ARVN)	420,000
NAVY (VNN)	31,500
AIR FORCE (VNAF)	35,600
MARINE CORPS (VNMC)	11,900
REGIONAL FORCES (RF)	258,500
POPULAR FORCES (PF)	216,500
TOTAL RVNAF	974,000

UNITED STATES FORCES

ARMY	330,896
NAVY	29,784
AIR FORCE	57,384
MARINE CORPS	55,503
COAST GUARD	383
TOTAL U.S.	473,950

FREE WORLD MILITARY ASSISTANCE FORCES (FWMAF)

REPUBLIC OF KOREA	48,860
AUSTRALIA	7,694
PHILIPPINES	143
THAILAND	11,568
NEW ZEALAND	556
REPUBLIC OF CHINA	29
SPAIN	10
TOTAL FWMAF	68,860

TOTAL FORCES IN RVN 1,516,810

SOURCE: RVNAF MACV MONTHLY GIVEN FORCES STRENGTH DATA REPORT.

ALL OTHER, MACV WEEKLY STRENGTH REPORT AS OF 2400,
22JAN70 USMC STRENGTH: MACV WK STRENGTH REPORT AS
ADJUSTED BY MACV REPORT OF ARR/DEP AS OF 2400, 31JAN70.

UNCLASSIFIED
UNCLASSIFIED

~~CONFIDENTIAL~~
UNCLASSIFIED

MARINE CORPS COMMAND CENTER

LANDING FORCE, SIXTH FLEET 3-69

2 FEBRUARY 1970

TF-61/62 CTG: LTCOL G. B. CRIST UNITS EMBARKED	STRENGTH				ARMS & EQUIPMENT	LOCATION AT NAPLES ETD: 7Feb70	
	USMC		USN				
	OFF	ENL	OFF	ENL			
BLT 2/6 (LTCOL G. B. CRIST)					31 7.62 MG 10 LVTP-5 6 105 HOW 5 90MM GUN TANK 5 ONTOS 8 81MM MORTARS 8 FLAME THROWERS 6 106MM RR	SHIPPING USS CAMBRIA (APA-36) USS LASALLE (LPD-3) USS RUSHMORE (LSD-14) USS WAHKIAKUM (LST-1162)	
2D BN, 6TH MAR	49	1030	4	33			
DET HQCO, 6TH MAR					21 MULES 32 MITES 22 2 1/2 TON TRUCKS 8 JEEPS 3 5 TON CARGO TRUCKS 9 3/4 TON UTIL TRUCKS 4 AMBULANCES 4 CRANES	SUPPLIES CLASS I CLASS II CLASS III CLASS IV CLASS V	
BTRY "E", 2/10	9	124					
DET HQ BTRY, 2/10	2	10		2	AIRCRAFT NO AIRCRAFT		
PLT CO "C", 2D AMTRAC BN	1	45					
PLT CO "B", 8TH MT BN		19					
PLT CO "C", 2D AT BN	1	21					
PLT CO "B", 2D ENGR BN		49					
PLT CO "A", 2D MED BN		10	1	9			
PLT CO "A", 2D TK BN	1	24					
PLT CO "A", 2D SP BN	1	49					
PLT CO "B", 2D RECON BN	1	24		1			
DET HQBN, 2D MARDIV		27					
DET 2D DENTAL CO			2	2			
DET 2D SERVICE BN	1	42					
DET 2D FSR		40					
TOTALS	66	1514	7	47			

LANDING FORCE, CARIBBEAN 1-70

30 JANUARY 1970

TASK GROUP 45.9 CTG: COL G. R. HUNTER UNITS EMBARKED	STRENGTH				ARMS & EQUIPMENT	LOCATION AT ROOSEVELT ROADS
	USMC		USN			
	OFF	ENL	OFF	ENL		
HO 36TH MEU					11 LVTP-5 5 M48 TANK 5 M50 ONTOS 6 105MM HOW TD 8 106MM RR 8 81MM MORTAR	SHIPPING USS GUADALCANAL (LPH-7) USS VERMILLION (LKA-107) USS SUFFOLK CTY (LST-1173) USS SPEIGEL GROVE (LSD-32)
BLT 3/2 (LTCOL E. F. PIERSON JR.)						
3D BN, 2D MARINES	44	1007	4	38	AIRCRAFT 19 CH-46D	SUPPLIES CLASS I CLASS II CLASS III CLASS IV CLASS V
BTRY "I", 3/10	10	136	1	2		
DET HQ BTRY, 3/10						
PLT CO "B", 2D AMTRAC BN	1	40				
PLT CO "C", 2D MT BN	1	33				
PLT CO "A", 2D AT BN	1	21				
PLT CO "A", 2D ENGR BN	1	49				
PLT M&S CO, 2D MED BN		10		17		
PLT CO "A", 2D TANK BN	1	24				
PLT CO "A", 2D SP BN	1	52		7		
PLT CO "C", 2D RECON BN	1	23		1		
DET HQBN, 2DMARDIV	1	25				
DET 2D DENTAL CO			1	1		
DET 2D SERV BN	1	40				
DET 2D FSR	1	37				
DET HQCO 2D MARINES		20				
HMM-261 (LTCOL V. M. HAZELBAKER)	43	170	1			
TOTALS	107	1687	7	61		

~~CONFIDENTIAL~~
UNCLASSIFIED
Unclassified

~~CONFIDENTIAL~~

MARINE CORPS COMMAND CENTER

SELECTED PERSONNEL AND AIRCRAFT DATA

UNCLASSIFIED

PERSONNEL

3 FEBRUARY 1970

	STRENGTH	PERCENT USMC	PERCENT FMF	PERCENT FMPAC
USMC TOTAL	300,982 *	100.00		
FLEET MARINE FORCES	153,954	51.15	100.00	
FMF ATLANTIC	42,404 \$	15.26	27.54	
FMF PACIFIC	108,033 #	35.89	70.17	
VIETNAM	54,674 †	18.16	35.86	50.62

SOURCE: * MONTHLY USMC PERSONNEL ALLOCATION REPORT OF 30NOV69.
 \$ MCCC UNIT REPORT OF 24DEC69.
 # MCCC UNIT REPORT OF 21JAN70.
 † MACV WEEKLY STRENGTH REPORT AS OF 2400, 15JAN70 AS ADJUSTED BY MACV REPORT OF ARR/DEPART AS OF 2400, 1FEB70.

AIRCRAFT

10 JANUARY 1970

	FIXW	HELO	TOTAL	PERCENT USMC	PERCENT FMF	PERCENT FMPAC
USMC TOTALS	1013	569	1582	100.00		
FLEET MARINE FORCES	768	547	1315	83.12	100.00	
FMF ATLANTIC	303	156	459	29.01	34.90	
FMF PACIFIC	465	391	856	54.11	65.10	
VIETNAM	197	195	392	24.78	29.81	45.79

SOURCE: MARINE CORPS COMMAND CENTER UNIT REPORT OF 31DEC69.

UNCLASSIFIED

Unclassified

~~CONFIDENTIAL~~

MARINE CORPS COMMAND CENTER

UNCLASSIFIED

FLEET MARINE FORCE DEPLOYMENTS

3 FEBRUARY 1970

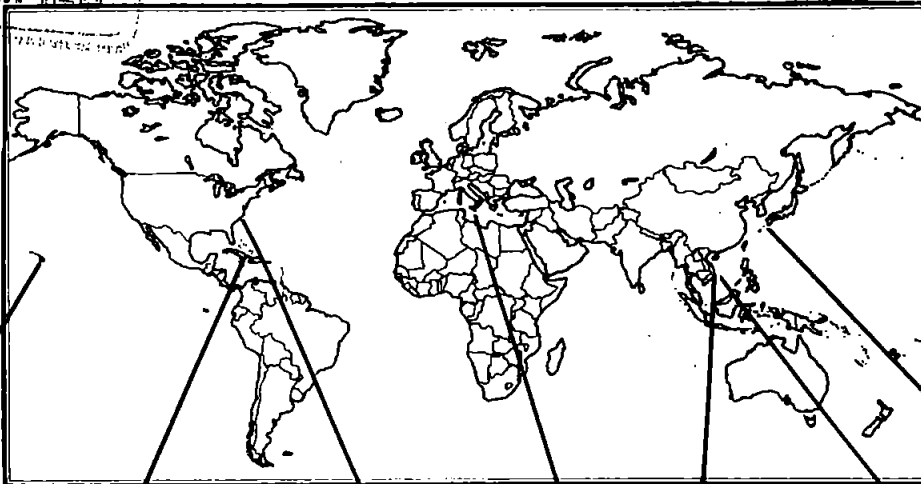

1ST MAR BRIG
HAWAII

GIMD AUGMENT

2D BN, 8TH MAR
BTRY B/1/10
PLT 2D TK BN
PLT 2D ANGLICO
DET FSR

LANFORCARIB 1-70

BLT 3/2 & HMM-261
ENR CRISTOBAL
ETA: 7FEB70

LANFOR6THFLT 3-69

AT NAPLES
ETD: 7FEB70

III MAF

RVN

SLF, 7TH FLEET

SLF BRAVO
EMBARKED ABOARD ARG
AND TO REMAIN IN PORT
AT SUBIC BAY.

I MEF

OKINAWA
& JAPAN
B/1/4 & 2D PLAT/B/3D
TK BN AT FUJI FOR
TRAINING.

SLF ALFA
AT OKINAWA

DISTRIBUTION OF MAJOR FMF UNITS

	INF BNS	VMFA	VMA	VMA(AW)	VMCJ	BMM	BMR	RML	VMO	VMGR
WESTPAC	18	5	2	3	1	6	2	2	2	1
RVN	(12)	(3)	(2)	(2)	(1)	(4)	(1)	(2)	(1)	
OKINAWA/JAPAN	(4)	(2)		(1)			(1)		(1)	(1)
ASSIGNED TO SLF'S	(2)					(2)				
MIDPAC	1	2								
HAWAII	(1)	(2)								
AFLOAT										
EASTPAC	2	3	2		1	2	2	1		1
WEST COAST	(2)	(3)	(2)		(1)	(2)	(2)	(1)		(1)
AFLOAT										
ATLANTIC	8	5	2	3	1	4	2		1	1
EAST COAST	(6)	(5)	(2)	(3)	(1)	(3)	(2)		(1)	(1)
CARIBBEAN	(2)					(1)				
EUROPE	1									
MEDITERRANEAN	(1)									
GRAND TOTAL	30	15	6	6	3	12	6	3	3	3

UNCLASSIFIED

UNCLASSIFIED

DISTRIBUTION OF PERSONNEL

FLEET MARINE FORCE, PACIFIC

3 FEBRUARY 1970

Main personnel distribution table with columns for UNIT, NOTE, ASSIGNED STRENGTH (USMC, USN), STRENGTH RPT DATE, and various geographic locations (DANANG, CHU LAI, PHU BAI, No I CTZ, OKINAWA, JAPAN, HAWAII, EASTPAC, OTHER).

RECAPITULATION OF FMFAC PERSONNEL DISTRIBUTION

Summary table showing personnel distribution by category (GROUND TOTAL, AVIATION TOTAL, GRAND TOTAL) and location (DANANG, CHU LAI, PHU BAI, No I CTZ, OKINAWA, JAPAN, HAWAII, EASTPAC, OTHER).

NOTES:

- 1. FIGURES IN "OTHER" ASSIGNED TO SLF'S.
2. FIGURES IN "OTHER" ASSIGNED TO VARIOUS LOCATIONS IN RVN.
3. PERSONNEL IN "OTHER" ARE ASSIGNED TO IT, ITT, SSC, CI TEAMS, RED EYE AND NUCLEAR ORDNANCE PLATOONS.
4. STRENGTH INCLUDED IN 1ST AND 3D TANK BATTALIONS.
5. THE 597 PERSONNEL LISTED IN "OTHER" ARE HOSPITALIZED AT LOCATIONS OTHER THAN OKINAWA, BUT ARE CARRIED ON THE ROLLS OF CASUAL COMPANY, MCB, CAMP BUTLER
6. AT SUBIC
* UNLESS OTHERWISE NOTED, STRENGTHS AND LOCATION ARE THOSE REPORTED BY UNIT PERSONNEL STATUS REPORTS AND DO NOT REFLECT DAY-TO-DAY ADJUSTMENTS BETWEEN PERIODS.
** UNLESS OTHERWISE NOTED, STRENGTH REPORT DATE IS 16JAN70.
7. ENROUTE EASTPAC

Unclassified

UNCLASSIFIED

SELECTED UNIT COMMANDERS AND STAFF OFFICERS

3 FEBRUARY 1970

HEADQUARTERS FLEET MARINE FORCE PACIFIC

COMMANDING GENERAL	LTGEN H. W. BUSE, JR.
DEPUTY COMMANDER	MGEN P. J. FONTANA
CHIEF OF STAFF	BGEN L. H. WILSON
ACOS, G-1	COL F. S. WOOD
ACOS, G-2	COL J. F. MITCHELL
ACOS, G-3	COL R. M. HALL
ACOS, G-4	COL J. B. SOPER
ACOS, G-5	LTCOL E. L. HICKAM

5TH MARINE EXPEDITIONARY BRIGADE

COMMANDING GENERAL	BGEN R. T. DWYER, JR.
ADC	
CHIEF OF STAFF	COL M. W. SCHMIDT
ACOS, G-1	COL E. R. DAZE
ACOS, G-2	MAJOR J. D. LITTLE
ACOS, G-3	COL J. P. KELLY
ACOS, G-4	COL G. R. STURDIVAN
HQ BN	LTCOL J. F. HEL
H&SCO	MAJ J. A. LINNEMANN
<u>3RD MARINES</u>	
COMMANDING OFFICER	COL W. A. BUTCHER
2ND BATTALION	LTCOL E. Z. GRABOWSKI
3RD BATTALION	LTCOL J. G. COLLIER
1STBN, 12THMAR	LTCOL J. F. HELSEL
M BTRY, 4THBN, 12THMAR	
CoA, 3D AT BN	CAPT C. W. FATTIG
CoA, 3D RECON BN	CAPT R. E. FIELDS, JR.
CoB, 3D ENGR BN	CAPT A. A. LOPEZ
CoB, 3D MT BN	CAPT M. A. SELBY
Co B, 3D SP BN	MAJ E. V. SULLIVAN, JR.
Co D, 3D TANK BN	CAPT W. J. DIBELLO
DET, 3D SERVICE BN	COL G. K. REID
COMM SPT CO, 9TH COMM BN	MAJ G. E. TEAGUE
Co B, 11TH ENGR BN	CAPT H. L. CAMPBELL
Co B, 9TH MT BN	CAPT C. D. GARRETT
Co A, 1ST AMTRAC BN	MAJ R. G. JONES
1ST SEARCHLIGHT BTRY	CAPT K. C. KALBFLEISCH
9TH SEP BULK FUEL CO	MAJ M. E. MC PHERSON
3D BRIDGE CO	CAPT D. E. PENMAN
1ST ARMD AMPHIB CO	MAJ R. D. DASCH
1ST CIVIL AFFAIRS GROUP	COL R. M. TAYLOR
3D HOSP CO	LCDR D. J. HIDE
Co C, 3D MED BN	LCDR C. H. MCALLISTER

1ST MARINE BRIGADE

COMMANDING OFFICER	COL B. G. CASS
S-1	LTCOL W. H. WAHFELD
S-2	CWO P. B. MURPHY
S-3	LTCOL J. R. W. COCHRAN
S-4	LTCOL E. L. CONROY
H&SCO	MAJ J. G. HANRAHAN
1ST BN, 3D MARINES	LTCOL D. J. HUNTER
<u>MAG-24</u>	
COMMANDING OFFICER	COL K. C. PALMER
H&MS-24	LTCOL W. H. HEINTZ
MABS-24	LTCOL A. B. COLBERT
MACS-2	LTCOL R. D. MILLER
VMFA-212	LTCOL H. H. ZIEGLER
VMFA-235	LTCOL L. A. MADERA
MATCU-70	MAJOR H. B. VERGARA
SU#2, 1ST RAD BN	MAJOR L. K. RUSSELL

FORCE TROOPS FMFPAC

COMMANDING GENERAL	BGEN C. W. HOFFMAN
ASSISTANT COMMANDER	COL A. B. CLARK
CHIEF OF STAFF	COL L. N. UTTER
ACOS, G-1	LTCOL D. K. GRAY
ACOS, G-2	1STLT R. COOK
ACOS, G-3	LTCOL W. R. MILLER, JR.
ACOS, G-4	LTCOL M. E. FARMER
<u>3RD FORCE SERVICE REGT</u>	
COMMANDING OFFICER	COL J. R. JONES
H&S BATTALION	LTCOL J. B. HARRIS
SUPPLY BATTALION	LTCOL R. E. ROURKE
MAINT BATTALION	LTCOL L. I. FEIN
<u>5TH FORCE SERVICE REGT</u>	
COMMANDING OFFICER	COL K. W. HENRY
H&S BATTALION	MAJOR J. A. SCHEARMAN, JR.
SUPPLY BATTALION	LTCOL R. O. BARNES
MAINT BATTALION	LTCOL J. M. HERMES
13TH MT BATTALION	MAJOR T. M. COLLINS
9TH COMM BATTALION	MAJ C. E. TEAGUE

UNCLASSIFIED

Unclassified

UNCLASSIFIED

MARINE CORPS COMMAND CENTER

SELECTED UNIT COMMANDERS AND STAFF OFFICERS

3 FEBRUARY 1970

1ST MARINE AIRCRAFT WING		3D MARINE AIRCRAFT WING	
COMMANDING GENERAL AWC	MGEN W. G. THRASH	COMMANDING GENERAL AWC	MGEN R. G. OWENS, JR.
CHIEF OF STAFF	BGEN R. H. SPANJER	CHIEF OF STAFF	BGEN J. A. FEELEY, JR.
ACOS, G-1	COL R. W. TELLER	ACOS, G-1	COL H. N. MEHAFFEY
ACOS, G-2	COL G. S. STEWART	ACOS, G-2	LTCOL L. A. GULLING
ACOS, G-3	COL J. R. WEAVER	ACOS, G-3	COL R. J. GRAHAM
ACOS, G-4	COL R. L. LAMAR	ACOS, G-4	COL D. WILKER
ACOS, COMPT	COL W. C. MCGRAW		
CEO	COL E. J. ARTNAK		
	LTCOL T. KALUS		
<u>MWHG-1</u>		<u>MWHG-3</u>	
COMMANDING OFFICER	COL L. J. STIEN	COMMANDING OFFICER	COL G. L. LILLICH
H&HS-1	MAJOR H. F. WITTER	H&HS-3	LTCOL J. B. LAVELLE
MWFS-1	LTCOL N. F. SCHNIPPEL, JR.	MWFS-3	MAJOR J. S. LOOP
MWCS-1	MAJOR A. B. RAY	MMCS-3	MAJOR D. B. NEWTON
<u>MWSG-17</u>		<u>MHTG-30</u>	
COMMANDING OFFICER	COL R. A. SAVAGE	COMMANDING OFFICER	COL A. F. GARROTTO
H&MS-17	LTCOL D. SERRIN	H&MS-30	LTCOL R. W. CREIGHTON
WERS-17	MAJOR W. F. FARLEY	HMHT-301	LTCOL L. W. JARMAN
		HMHT-302	LTCOL K. D. VANEK
<u>MACG-18</u>		<u>MAG-33</u>	
COMMANDING OFFICER	COL S. G. DUNWIDDIE, JR.	COMMANDING OFFICER	COL F. N. PIPPIN
H&HS-18	LTCOL H. E. HOPPEYER, JR.	H&MS-33	LTCOL R. H. HUTCHINSON
MACS-4	LTCOL R. W. MOLYNEUX, JR.	MABS-33	MAJOR J. E. KEHRLE
		VMCJ-3	LTCOL R. E. PERCIVAL
<u>MASS-3</u>		VMA-214	LTCOL W. R. SMITH
	LTCOL J. H. DUBOTS	VMFA-323	MAJ K. A. ZIMMERMAN II
		VMFAT-101	LTCOL R. W. KRON
<u>MAG-11</u>		VMFA-531	LTCOL J. L. THATCHER
COMMANDING OFFICER	COL N. E. HEFFERNAN	VMFA-542	LTCOL K. A. SMITH
H&MS-11	LTCOL R. F. HEBERT	VMA-223	LTCOL J. W. IAZZO
MABS-11	LTCOL P. A. MANNING		
VMCJ-1	LTCOL B. W. FARLEY	<u>MWSG-37</u>	
VMA(AW)-225	LTCOL J. J. METZKO	COMMANDING OFFICER	COL F. E. WILLSON
		H&MS-37	LTCOL D. L. RICE
VMA(AW)-242	LTCOL S. P. LEWIS	WERS-37	LTCOL R. W. DUPHINEY
		VMGR-352	LTCOL H. D. STOTT
<u>MAG-12</u>		<u>MACG-38</u>	
COMMANDING OFFICER	COL F. B. HENLEY	COMMANDING OFFICER	LTCOL T. I. GUNNING
H&MS-12	LTCOL J. J. WENT	H&HS-38	MAJOR F. L. HARDING
MABS-12	LTCOL G. J. ERTLMEIR	SU#1, H&HS-38	MAJOR D. V. STOWELL
VMA-311	MAJOR A. R. HICKLE	MACS-1	MAJ C. F. KELLENBARGER
		MACS-3	LTCOL T. M. KAUFFMAN
VMA-211	LTCOL L. GASPERINE, JR.	MACS-7	LTCOL D. E. ROBERTS
VMA-223	LTCOL J. W. IAZZO	1STLAAM BN	MAJOR E. L. HOUSE, JR.
		2NDLAAM BN	MAJOR H. J. BALDWIN, JR.
<u>MAG-13</u>		<u>MAG-56</u>	
COMMANDING OFFICER	LTCOL T. E. MURPHREE	COMMANDING OFFICER	COL M. D. PORTER
H&MS-13	MAJOR F. J. HORAK, JR.	H&MS-56	LTCOL G. H. BUCKNER II
MABS-13	MAJOR R. D. REVIE	MABS-56	LTCOL F. L. YOHE
VMFA-115	LTCOL D. P. BOWEN	HMH-363	LTCOL R. P. BRAY
VMFA-314	LTCOL T. J. KELLY	HML-267	LTCOL J. M. BLANC
		HML-361	LTCOL K. W. ANDRUS
VMFA-122	LTCOL R. E. HOWARD, JR.	HMM-163	LTCOL F. A. MATHEWS
		HMM-265	LTCOL R. G. COUNTRY
<u>MAG-16</u>		<u>MCCRTG-10</u>	
COMMANDING OFFICER	COL J. P. BRUCE	COMMANDING OFFICER	COL G. FINK
H&MS-16	MAJOR M. T. HORNSBY	H&MS-10	MAJ I. L. DRIEFER
MABS-16	LTCOL P. C. SCAGLIONE	VMAT-102	LTCOL B. A. SCHAFFER
VMO-2	LTCOL J. M. MORIARITY	VMT-103	LTCOL M. T. GARRISON
HMH-463	LTCOL C. A. BLOCK		
HML-167	LTCOL J. E. WEBER		
HMM-364	LTCOL C. R. DUNBAUGH		
HMM-263	LTCOL W. R. LEDBETTER		
HMM-161	MAJOR B. H. MANN		
HMM-262	LTCOL R. A. BANCROFT		
HML-367	LTCOL W. G. CRETNEY		

UNCLASSIFIED

Unclassified

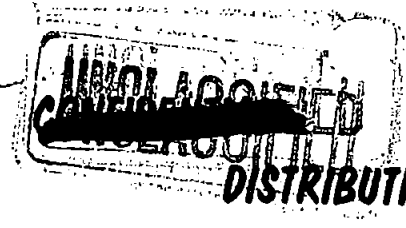

MARINE CORPS COMMAND CENTER

DISTRIBUTION OF MAJOR FMFPAC TACTICAL UNITS

3 FEBRUARY 1970

UNIT	CHU LAI	DANANG	NoICTZ/DMZ	OKINAWA	JAPAN	HAWAII	EASTPAC	OTHER	NOTE
1ST MARINES		1/1, 2/1, 3/1							
3D MARINES						1/3	2/3, 3/3		
4TH MARINES				1/4, 2/4, 3/4					
5TH MARINES		1/5, 2/5, 3/5							
7TH MARINES		1/7, 2/7, 3/7							
9TH MARINES					3/9			1/9, 2/9	1
26TH MARINES		1/26, 2/26, 3/26							
MAG-11		VMCJ-1 VMA(AW)-229 VMA(AW)-242							
MAG-12	VMA-211 VMA-223 VMA-311								
MAG-13	VMFA-115 VMFA-314 VMFA-122								
MAG-16		VMO-2 HML-167 HMH-463 HMM-263 HMM-364	HMM-161 HML-367 HMM-262						
MAG-36				HMH-462 VMO-6				HMM-164 HMM-165	1 1
MAG-15					VMFA-232 VMFA-334 VMA(AW)-533				
MAG-24						VMFA-212 VMFA-235			
MAG-33							VMA-223 VMCJ-3 VMA-214 VMFA-323 VMFA-531 VMFA-542 HML-267 HMM-363 HMM-163 HMH-361 HMM-265		2 2
MAG-56									2

DISTRIBUTION OF MAJOR GROUND EQUIPMENT

EQUIPMENT	T/E AUTH	CHU LAI	DANANG	NoICTZ/DMZ	OKINAWA	HAWAII	EASTPAC	OTHER	NOTE
60mm MORTAR M19	254		144		60	12	24	12	1
81mm MORTAR M29	168		96		40	8	16	8	1
106mm RR M40A1C	168		96		40	8	16	8	1
107mm MORTAR M30	42		24		6	6		6	1
105mm HOW TD M101A1	136		72		30	6	12	6	1
155mm HOW SP M109	42		24		12		6		
175mm GUN (SP)	18		12	6					
81n HOW SP M110	14		12	2					
ONTOS M50A1	115		15		75		15	10	1
90mm TANK M48A3	126		73		36		17		
120mm TANK M103A2	17						17		
FLAME TANK M67A2	27		12		9		6		
LVTH6	18		6		12				
LVTP5	280		112		113		44	11	1
LVTE1	24		8		8		8		
HAWK LAUNCHERS	36						36		

NOTES: 1. UNITS/EQUIPMENT IN OTHER ASSIGNED TO SLF's.
2. ENROUTE CONUS.
3. ENROUTE OKINAWA.

Unclassified

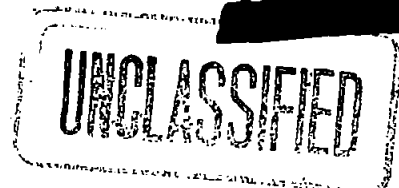

~~CONFIDENTIAL~~
UNCLASSIFIED

DISTRIBUTION OF AIRCRAFT, FMFPAC

3 FEBRUARY 1970

UNIT	DANANG	CHU LAI	PHU BAI	SKIMAWA	JAPAN	HAWAII	EASTPAC	OTHER
HQ SQDN, FMFPAC						6/T-1A 1/C-54R 1/C-47J		
MAG-11 H&MS-11	8/TA-4F 1/C-117D							
VMCJ-1	9/RF-4B							
VMA(AW)-242	8/EA-6A							
VMA(AW)-225	12/A-6A 11/A-6A							
MAG-12 H&MS-12		1/C-117D						
VMA-211		19/A-4E						
VMA-311		19/A-4E						
MAG-13 H&MS-13		1/C-117D						
VMFA-115		14/F-4B						
VMFA-314		15/F-4B						
VMFA-122		11/F-4B						
MAG-15 H&MS-15					1/C-54Q 1/C-117D 3/TA-4F 1/C-54S			
VMFA-232					14/F-4J			
VMFA-334					12/F-4J			
VMA(AW)-533					11/A-6A			
MAG-16 H&MS-16	1/C-117D		1/C-117D					
VMO-2	23/AH-1G 19/OV-10A		1/CH-46A					
HML-167	25/UH-1E		24/UH-1E					
HML-367								
HMM-263	21/CH-46D							
HMM-161			21/CH-46D					
HMM-262			21/CH-46D					
HMM-364	20/CH-46D							
HMH-463	21/CH-53A/T							
MCCRTG-10 H&MS-10								
VMAT-102							26/A-4C	
VMT-103							16/TA-4F	
MWSG-17 H&MS-17	3/US-2B 3/C-117D							
MHTG-30 H&MS-30							5/CH-46D	
HMHT-301							14/CH-53A	
HMMT-302							18/CH-46D	
MAG-33 H&MS-33							2/F-4B 6/TA-4F	
VMA-223							20/A-4E	**
VMCJ-3							8/RF-4B 1/F-4B 12/EF-10B 23/A-4C	
VMA-214							12/F-4B	
VMFA-323							23/F-4B	
VMFA-531							15/F-4B	**
VMFAT-101								
VMFA-542								
MAG-36 H&MS-36				1/C-117D				
VMGR-152				1/CH-46A				
VMGR-152				12/KC-130F				
HMM-165								18/CH-46D
HMM-164								19/CH-46A
HMH-462				20/CH-53A				
VMO-6				11/UH-1E				
				18/OV-10A				

NOTES: * ASSIGNED TO SLF's
** ENROUTE CONUS

~~CONFIDENTIAL~~

UNCLASSIFIED

Unclassified

UNCLASSIFIED
~~CONFIDENTIAL~~

MARINE CORPS COMMAND CENTER

DISTRIBUTION OF AIRCRAFT, FMFPAC

3 FEBRUARY 1970

UNIT	BARANG	CHU LAI	PHU DAI	OKINAWA	JAPAN	HAWAII	EASTPAC	OTHER
MWSG-37 H&MS-37							2/C-47J 1/C-54R 2/C-117D 1/C-47H	
VMGR-352							11/KC-130F	
MAG-56 H&MS-56							4/CH-46D 11/CH-53A 1/UH-1E	
HMM-163							25/CH-46F	
HML-267							7/OV-10A 16/UH-1E 14/CH-53A	**
HMH-361							19/CH-53A	
HMH-363							7/CH-46D	
HMM-265							1/CH-53A	
MABS-56								
1ST MARINE BRIGADE								
MAG-24 H&MS-24						1/C-117D 6/UH-34D 3/TA-4F		
VMFA-212						15/F-4J		
VMFA-235						14/F-4J		
TOTAL FMFPAC ACFT								
FIXED WING (460)	75	80	1	31	43	41	189	
HELICOPTERS (387)	110		68	32		6	134	37

NOTE: * ASSIGNED TO SLF's
 ** ENROUTE CONUS

UNCLASSIFIED

Unclassified

SECRET

UNCLASSIFIED

MARINE CORPS COMMAND CENTER

MARINE CORPS PERSONNEL IN RVN

3 FEBRUARY 1970

	OFF	ENL	TOTAL
* III MAF	3,717	50,645	54,362
DANANG	(3,159)	(43,799)	(46,958)
CHU LAI	(395)	(4,888)	(5,283)
PHU BAI	(126)	(1,211)	(1,337)
DONG HA	(37)	(747)	(784)
SU #1, 1ST ANGLICO (AT VARIOUS LOCATIONS SVN)	((22))	((192))	((214))
OTHER USMC PERSONNEL	160	152	312
MACV STAFF/MACV FIELD	(136)	(139)	(275)
NAVAVGRU/NAVY UNITS	(24)	(13)	(37)
USMC IN RVN CHARGED AGAINST PROGRAM VIII	3,877	50,797	54,674
U. S. NAVY, III MAF	267	1,916	2,183

* AS REPORTED BY III MAF DAILY ADMIN SITREP # 0028 AS OF 2400, 27JAN70 AND ADJUSTED IN ACCORDANCE WITH MACV WEEKLY STRENGTH REPORT AND DAILY MACV REPORTS OF ARRIVALS/DEPARTURES AS OF 2400, 1 FEB 70.

UNCLASSIFIED

SECRET

UNCLASSIFIED

MARINE CORPS COMMAND CENTER
WESTPAC UNIT LOCATIONS

3 FEBRUARY 1970

QUANG TRI (QUANG TRI CITY)	USMC 784 USN 39 USA 5,800
1ST BDE, 5TH INF DIV (MECH) 1/77 ARMOR (OPN GREEN RIVER) 1/61 INF (MECH) (OPN GREEN RIVER) 1/11 INF (OPN GREEN RIVER) 3/5 ARMD CAV SQDN (OPN GREEN RIVER)	

THUA THIEN HQ, XXIV CORPS (PHU BAI) HQ, 101st ABN DIV (AM)	USMC 1,337 USN 44 USA 26,050
1ST BDE, 101ST ABN DIV (AM) 1/327 INF (AM) (OPN RANDOLPH GLEN) 2/327 INF (AM) (OPN RANDOLPH GLEN) 2/502 INF (AM) (OPN RANDOLPH GLEN)	
2D BDE, 101ST ABN DIV (AM) 1/501 INF (AM) (OPN RANDOLPH GLEN) 2/501 INF (AM) (OPN RANDOLPH GLEN) 1/502 INF (AM) (OPN RANDOLPH GLEN)	1st MAW MAG-16 HML-367 (UH-1E) HMM-262 (CH-46D) HMM-161 (CH-46D)
3D BDE, 101ST ABN DIV (AM) 1/506 INF (AM) (OPN RANDOLPH GLEN) 2/506 INF (AM) (OPN RANDOLPH GLEN) 3/187 INF (AM) (OPN RANDOLPH GLEN)	

QUANG NAM HOS, III MAF HOS 1ST MAR DIV (DANANG)	USMC 46,958 USN 1,970 USA 1,058 ROKMC 7,145
1ST MARINES 1/1 2/1 3/1	HO 1st MAW MAG-11
5TH MARINES 1/5 2/5 3/5	VMA(AW)-242 (A-6A) VMA(AW)-225 (A-6A) VMCJ-1 (RF-4/EA-6/EF-10)
7TH MARINES 1/7 2/7 3/7	MAG-16 (-) VMO-6 (UH/1E/OV-10A/AH-1G) HML-167 (UH-1E) HMH-463 (CH-53A) HMM-364 (CH-46D) HMM-263 (CH-46D)
26TH MARINES 1/26 2/26 3/26	2d ROKMC BDE 1/2 (OPN VICTORY DRAGON XIX-1) 2/2 (OPN VICTORY DRAGON XIX-21) 3/2 (OPN VICTORY DRAGON XIX) 5/2 (OPN VICTORY DRAGON XIX)

QUANG TIN/QUANG NGAI HO 23d INF DIV (AMERICAN) (CHU LAI)	USMC 5,283 USN 130 USA 24,106
196TH LT INF BDE 2/1 INF (OPN FREDERICK HILL) 4/31 INF (OPN FREDERICK HILL) 3/21 INF (OPN FREDERICK HILL) 1/46 INF	1st MAW MAG-12 (A-4E) VMA-211 (A-4E) VMA-311 (A-4E)
198TH LT INF BDE 1/6 INF (OPN GENEVA PARK) 1/52 INF (OPN GENEVA PARK) 5/46 INF (OPN NANTUCKET BEACH)	MAG-13 VMFA-115 (F-4B) VMFA-314 (F-4B) VMFA-122 (F-4B)
11TH INF BDE 1/20 INF (OPN IRON MOUNTAIN) 4/21 INF (OPN IRON MOUNTAIN) 3/1 INF (OPN IRON MOUNTAIN) 4/3 INF (OPN IRON MOUNTAIN) 1/1 ARMD CAV SQDN (OPN IRON MOUNTAIN)	

OKINAWA HQ, I MEF 3D MARDIV (-) (REIN)	USMC 19,200 USN 934
4TH MARINES 1/4 2/4 3/4	9TH MARINES 3/9
	MAG-36 VMGR-152 (KC-130F) VMO-6 (OV-10A) HMH-462 (CH-53A)
	3D FSR (3,175) (50) MCB CAMP BUTLER/NON FMP (920) (25) Non-Deployable Casuals (171) SVN-Originated Patients (0)
	OSD PROGRAM VIII CEILING 19,200 934 ACTUALS CHARGED AGAINST PROGRAM VIII AS OF 15JAN70. 18,255 424 (13,989) (349)

USMC RVN RECAP	USMC	USN
OSD PROGRAM VIII CEILING	55,510	2,233
ACTUALS CHARGED AGAINST PROGRAM VIII AS OF 1Feb70	54,674	2,183
III MAF	54,362	2,183
SU#1, 1ST ANGLICO	((214))	((14))
MACV STF/MACV FLD	(275)	
NAVAV/GRU/NAVY UNITS	(37)	

I CORPS RECAP		
US MARINE CORPS	(12 BNs)	54,362
US ARMY	(25 BNs)	73,849
US NAVY		17,097
US AIR FORCE		8,194
ROKMC	(4 BNs)	7,145
RVNAF	(36 BNs)	149,640
ARVN/ABN	(36 BNs)	(73,607)
VNMC		
VNN		(2,092)
VNAF		(3,416)
VNRF		(36,339)
VNPF		(34,186)
I CORPS TOTAL	77 BNs	310,296

SLF 7TH FLEET	USMC	USN
BRavo: BLT 2/9 HMM-165 AT SUBIC EMBARKED ABOARD AMG AND TO REMAIN IN FORT	1,847	60
ALFA: BLT 1/9 HMM-164 AT OKINAWA	1,868	85

MOVEMENTS
B/1/4 & 2D Plat/B/3D Tk Bn at Fuji for training.
Det 12THAR and "D" Co, 3D Recon at Namazu.

JAPAN	USMC	USN
OSD PROGRAM VIII CEILING	3,600	45
ACTUALS CHARGED AGAINST PROGRAM VIII AS OF 15JAN70.	3,455	34
1ST MAW (REAR)	(2,244)	(34)
MAG-15		
VMFA-232 (F-4J)		
VMFA-334 (F-4J)		
VMA(AW)-533 (A-6A)		

*Does NOT include 295 hospitalized SVN-Originated Patients.
Unclassified
Non FMP (1,211)

* Includes only U. S. Navy Personnel organic to FMP Units.
Includes SU#1 and 1st ANGLICO at various locations throughout SVN.
• Latest Change

UNCLASSIFIED

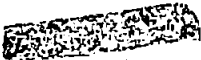

MARINE CORPS

FEB 3 1970

REFERENCE BRANCH

Unclassified



UNCLASSIFIED

MAJOR RVNAF OPERATIONS IN PROGRESS

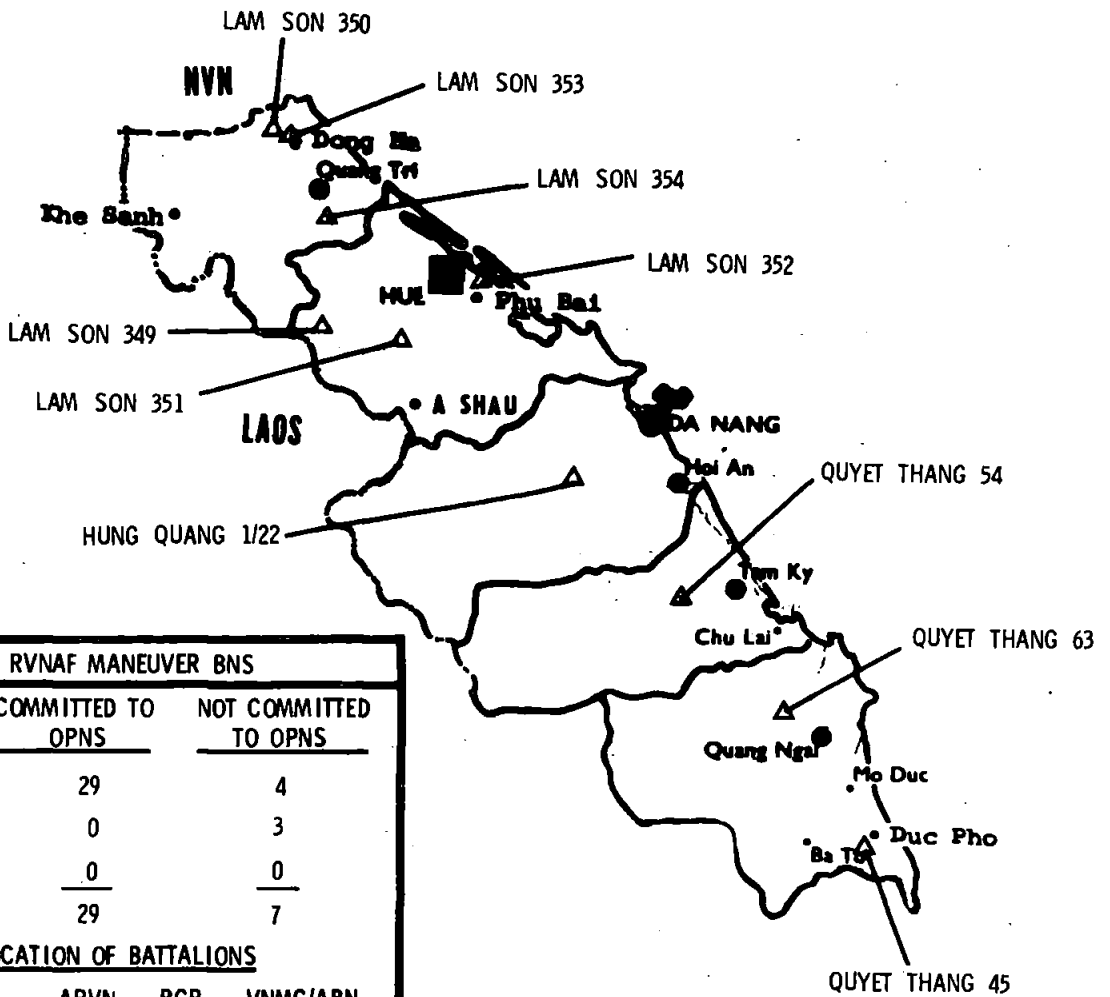

I CTZ RVNAF MANEUVER BNS			
TOTAL BNS	COMMITTED TO OPNS	NOT COMMITTED TO OPNS	
ARVN	33	29	4
RANGER	3	0	3
VNMC/ABN	0	0	0
	36	29	7

LOCATION OF BATTALIONS			
	ARVN	RGR	VNMC/ABN
QUANG TRI	6	0	0
THUA THIEN	11	0	0
QUANG NAM	5	1	0
QUANG TIN	3	2	0
QUANG NGAI	8	0	0

17-1

~~SECRET~~
UNCLASSIFIED

Unclassified

~~SECRET~~
UNCLASSIFIED

MAJOR US AND FWMAF OPERATIONS IN PROGRESS

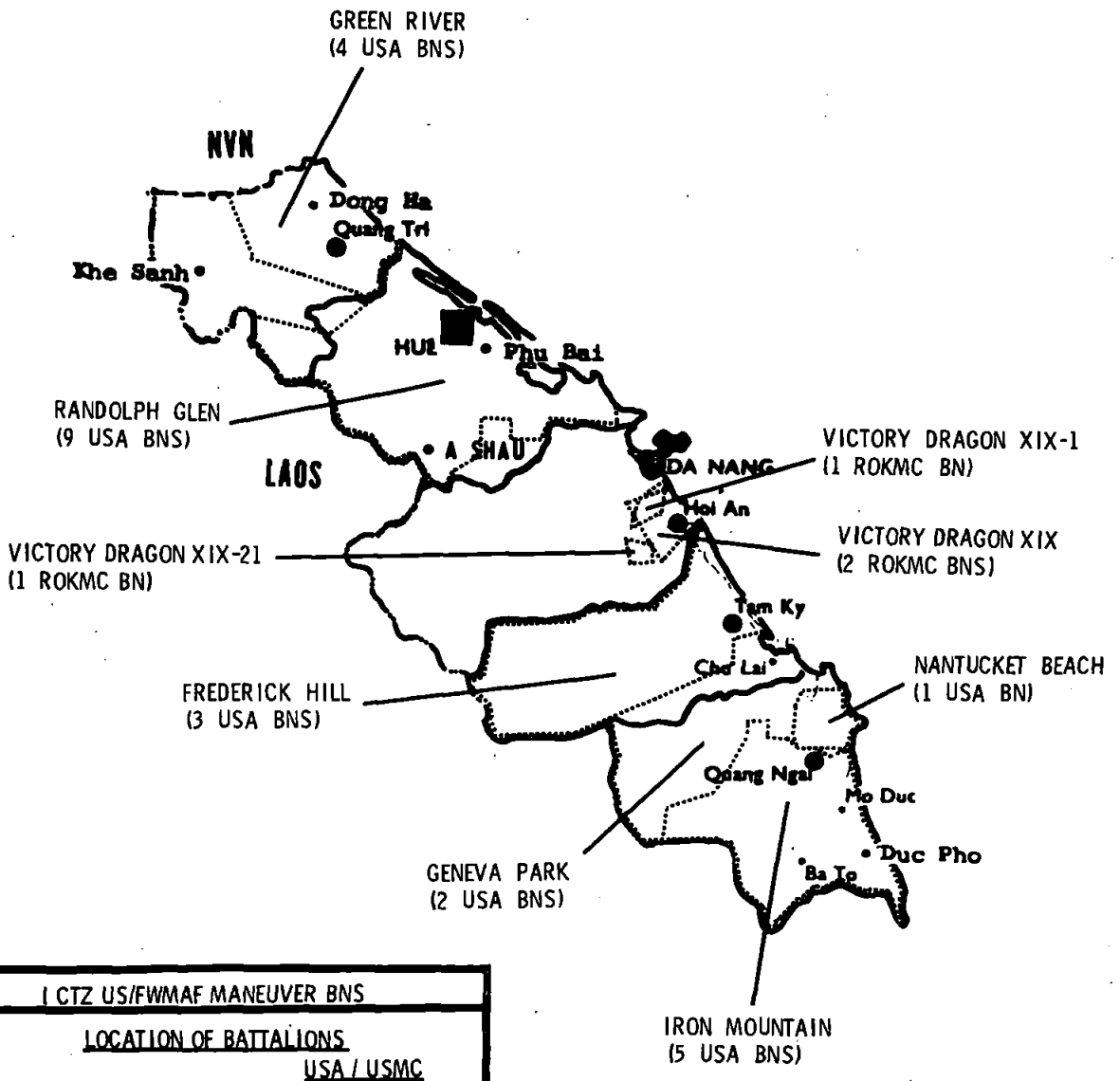

ICZ US/FWMAF MANEUVER BNS		
LOCATION OF BATTALIONS	USA / USMC	
	QUANG TRI	4
THUA THIEN	9	0
QUANG NAM *	0	12
QUANG TIN	4	0
QUANG NGAI	8	0

* FOUR ROKMC BNS ALSO LOCATED IN QUANG NAM

19-1

~~SECRET~~
UNCLASSIFIED

~~UNCLASSIFIED~~

SUMMARY OF MAJOR US AND FWMAF OPERATIONS

OPERATION (DATE COMMENCED)	UNITS INVOLVED	LOCATION	CASUALTIES AS OF: 032400H FEB70		
			FRIENDLY		ENEMY
			KIA	WIA	KIA
GREEN RIVER (19JAN70)	1ST BDE, 5TH INF DIV (MECH): 4 USA BNS	EASTERN QUANG TRI PROVINCE	2	59	23
RANDOLPH GLEN (7DEC69)	101ST ABN DIV (AM): 9 USA BNS	QUANG TRI & THUA THIEN PROVINCES	39	216	314
VICTORY DRAGON XIX (1JAN70)	2D ROKMC BDE: 2 BNS	HOI AN AREA	NONE	9	9
VICTORY DRAGON XIX-1 (25JAN70)	2D ROKMC BDE: 1 BN	HOI AN AREA	NONE	7	36
VICTORY DRAGON XIX-21 (31JAN70)	2D ROKMC BDE: 1 BN	HOI AN AREA	1	2	1
FREDERICK HILL (18MAR69)	196TH INF BDE: 3 USA BNS	QUANG TIN PROVINCE	366	2,277	4,381
GENEVA PARK (18JUL69)	198TH INF BDE: 2 USA BNS	QUANG TIN & QUANG NGAI PROVINCES	124	839	1,112
NANTUCKET BEACH (20JUL69)	198TH INF BDE: 1 USA BN	CENTERED 15 KM NE OF QUANG NGAI CITY	23	197	239
IRON MOUNTAIN (18MAR69)	11TH INF BDE: 5 USA BNS	QUANG NGAI PROVINCE	287	1,628	2,426

- - ADJUSTED
- # - FINAL CUMULATIVE CASUALTIES

~~SECRET~~
UNCLASSIFIED

Unclassified

UNCLASSIFIED

MARINE CORPS COMMAND CENTER

USMC/ENEMY CASUALTIES IN RVN

3 FEBRUARY 1970

USMC BATTLE CASUALTIES

KIA/DOW	WIA(EVAC)	WIA(RTD)	MIA/PW
12,421	48,716	35,715	83/21

USMC CASUALTY FIGURES ARE PROVIDED DAILY BY HQMC CASUALTY SECTION (CODE DNA) AND REFLECT ALL CASUALTIES REPORTED AS OF 2FEB70

USMC NON-BATTLE CASUALTIES

DEAD	INJURED	MISSING
1,497	1,818	8

FIGURES INDICATED AS INJURED ARE ONLY THOSE IN SERIOUS/CRITICAL INJURY OR DISEASE CATEGORY AND DO NOT INCLUDE THOSE OF A MINOR NATURE

USMC INFLECTED ENEMY CASUALTIES

KIA	PW	WPNS
80,152	4,113	20,616

ENEMY CASUALTIES ARE COMPILED DAILY FROM THE III MAF HISSUM AND ARE RECONCILED MONTHLY WITH THE FMFPAC SUMMARY OF USMC OPERATIONS IN RVN

TYPICAL DISPOSITION OF 100 USMC WIA *

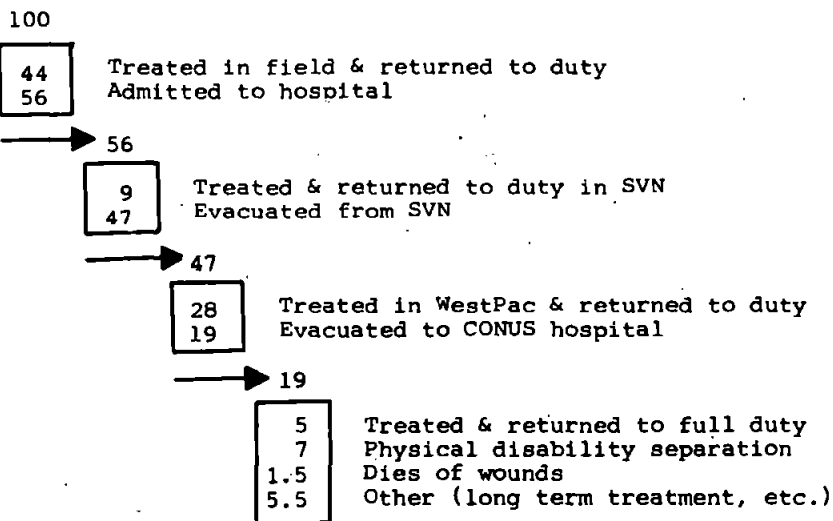

*54,081 CASUALTIES, JAN67-DEC68.

UNCLASSIFIED

Unclassified

~~CONFIDENTIAL~~
UNCLASSIFIED

MARINE CORPS COMMAND CENTER

MILITARY FORCES IN RVN *

3 FEBRUARY 1970

RVN ARMED FORCES (RVNAF)

ARMY (ARVN)	420,000
NAVY (VNN)	31,500
AIR FORCE (VNAF)	35,600
MARINE CORPS (VNMC)	11,900
REGIONAL FORCES (RF)	258,500
POPULAR FORCES (PF)	216,500
TOTAL RVNAF	974,000

UNITED STATES FORCES

ARMY	330,896
NAVY	29,784
AIR FORCE	57,384
MARINE CORPS	54,674
COAST GUARD	383
TOTAL U.S.	473,121

FREE WORLD MILITARY ASSISTANCE FORCES (FWMAF)

REPUBLIC OF KOREA	48,860
AUSTRALIA	7,694
PHILIPPINES	143
THAILAND	11,568
NEW ZEALAND	556
REPUBLIC OF CHINA	29
SPAIN	10
TOTAL FWMAF	68,860

TOTAL FORCES IN RVN 1,515,981

SOURCE: RVNAF MACV MONTHLY GIVEN FORCES STRENGTH DATA REPORT.

ALL OTHER, MACV WEEKLY STRENGTH REPORT AS OF 2400,
22JAN70 USMC STRENGTH: MACV WK STRENGTH REPORT AS
ADJUSTED BY MACV REPORT OF ARR/DEP AS OF 2400, 1FEB70

UNCLASSIFIED
~~CONFIDENTIAL~~

MARINE CORPS COMMAND CENTER

UNCLASSIFIED

LANDING FORCE, SIXTH FLEET 3-69

2 FEBRUARY 1970

UNITS EMBARKED	STRENGTH				ARMS & EQUIPMENT	LOCATION
	USMC		USN			
	OFF	ENL	OFF	ENL		
TP-61/62 CTG: LTCOL G. B. CRIST					31 7.62 MG	AT NAPLES
BLT 2/6 (LTCOL G. B. CRIST)					10 LVTP-5	ETD: 7Feb70
2D BN, 6TH MAR	49	1030	4	33	6 105 HOW	
DET HQCO, 6TH MAR					5 90MM GUN TANK	
BTRY "E", 2/10	9	124			5 ONTOS	
DET HQ BTRY, 2/10	2	10		2	8 81MM MORTARS	
PLT CO "C", 2D AMTRAC BN	1	45			8 FLAME THROWERS	
PLT CO "B", 8TH MT BN		19			6 106MM RR	
PLT CO "C", 2D AT BN	1	21			21 MULES	
PLT CO "B", 2D ENGR BN		49			32 MITES	
PLT CO "A", 2D MED BN		10	1	9	22 2 1/2 TON TRUCKS	
PLT CO "A", 2D TK BN	1	24			8 JEEPS	
PLT CO "A", 2D SP BN	1	49			3 5 TON CARGO TRUCKS	
PLT CO "B", 2D RECON BN	1	24		1	9 3/4 TON UTIL TRUCKS	
DET HQBN, 2D MARDIV		27			4 AMBULANCES	
DET 2D DENTAL CO			2	2	4 CRANES	
DET 2D SERVICE BN	1	42				
DET 2D FSR		40				
TOTALS	66	1514	7	47	AIRCRAFT NO AIRCRAFT	SHIPPING USS CAMBRIA (APA-36) USS LASALLE (LPD-3) USS RUSHMORE (LSD-14) USS WAHKIAKUM (LST-1162)
						SUPPLIES CLASS I CLASS II CLASS III CLASS IV CLASS V

LANDING FORCE, CARIBBEAN 1-70

3 FEBRUARY 1970

UNITS EMBARKED	STRENGTH				ARMS & EQUIPMENT	LOCATION
	USMC		USN			
	OFF	ENL	OFF	ENL		
TASK GROUP 45.9 CTG: COL G. R. HUNTER					11 LVTP-5	ENR CRISTOBAL
HO 36TH MEU BLT 3/2 (LTCOL E. F. PIERSON JR.)					5 M48 TANK	ETA: 7FEB70
3D BN, 2D MARINES	44	1007	4	38	5 M50 ONTOS	
BTRY "I", 3/10	10	136	1	2	6 105MM HOW TD	
DET HQ BTRY, 3/10					8 106MM RR	
PLT CO "B", 2D AMTRAC BN	1	40			8 81MM MORTAR	
PLT CO "C", 2D MT BN	1	33				
PLT CO "A", 2D AT BN	1	21				
PLT CO "A", 2D ENGR BN	1	49				
PLT H&S CO, 2D MED BN		10		17		
PLT CO "A", 2D TANK BN	1	24				
PLT CO "A", 2D SP BN	1	52		7		
PLT CO "C", 2D RECON BN	1	23		1		
DET HQBN, 2D MARDIV	2	25				
DET 2D DENTAL CO			1	1		
DET 2D SERV BN	1	40				
DET 2D FSR	1	37				
DET HQCO 2D MARINES		20				
HMM 261 (LTCOL V. M. HAZELBAKER)	43	170	1			
TOTALS	107	1687	7	61	AIRCRAFT 19 CH-46D	SHIPPING USS GUADALCANAL (LPH-7) USS VERMILLION (LKA-107) USS SUFFOLK CTY (LST-1173) USS SPEIGEL GROVE (LSD-32)
						SUPPLIES CLASS I CLASS II CLASS III CLASS IV CLASS V

UNCLASSIFIED

Unclassified

~~CONFIDENTIAL~~

MARINE CORPS COMMAND CENTER

UNCLASSIFIED
UNCLASSIFIED

SELECTED PERSONNEL AND AIRCRAFT DATA

PERSONNEL

4 FEBRUARY 1970

	STRENGTH	PERCENT USMC	PERCENT FMF	PERCENT FMFPAC
USMC TOTAL	300,982 *	100.00		
FLEET MARINE FORCES	153,954	51.15	100.00	
FMF ATLANTIC	42,404 \$	15.26	27.54	
FMF PACIFIC	108,033 #	35.89	70.17	
VIETNAM	54,537 †	18.16	35.86	50.62

SOURCE: * MONTHLY USMC PERSONNEL ALLOCATION REPORT OF 30NOV69.

\$ MCCC UNIT REPORT OF 24DEC69.

MCCC UNIT REPORT OF 21JAN70.

† MACV WEEKLY STRENGTH REPORT AS OF 2400, 15JAN70 AS ADJUSTED BY MACV REPORT OF ARR/DEPART AS OF 2400, 2FEB70

AIRCRAFT

10 JANUARY 1970

	FIXW	HELO	TOTAL	PERCENT USMC	PERCENT FMF	PERCENT FMFPAC
USMC TOTALS	1013	569	1582	100.00		
FLEET MARINE FORCES	768	547	1315	83.12	100.00	
FMF ATLANTIC	303	156	459	29.01	34.90	
FMF PACIFIC	465	391	856	54.11	65.10	
VIETNAM	197	195	392	24.78	29.81	45.79

SOURCE: MARINE CORPS COMMAND CENTER UNIT REPORT OF 31DEC69.

UNCLASSIFIED

Unclassified

~~CONFIDENTIAL~~

UNCLASSIFIED

MARINE CORPS COMMAND CENTER

FLEET MARINE FORCE DEPLOYMENTS

4 FEBRUARY 1970

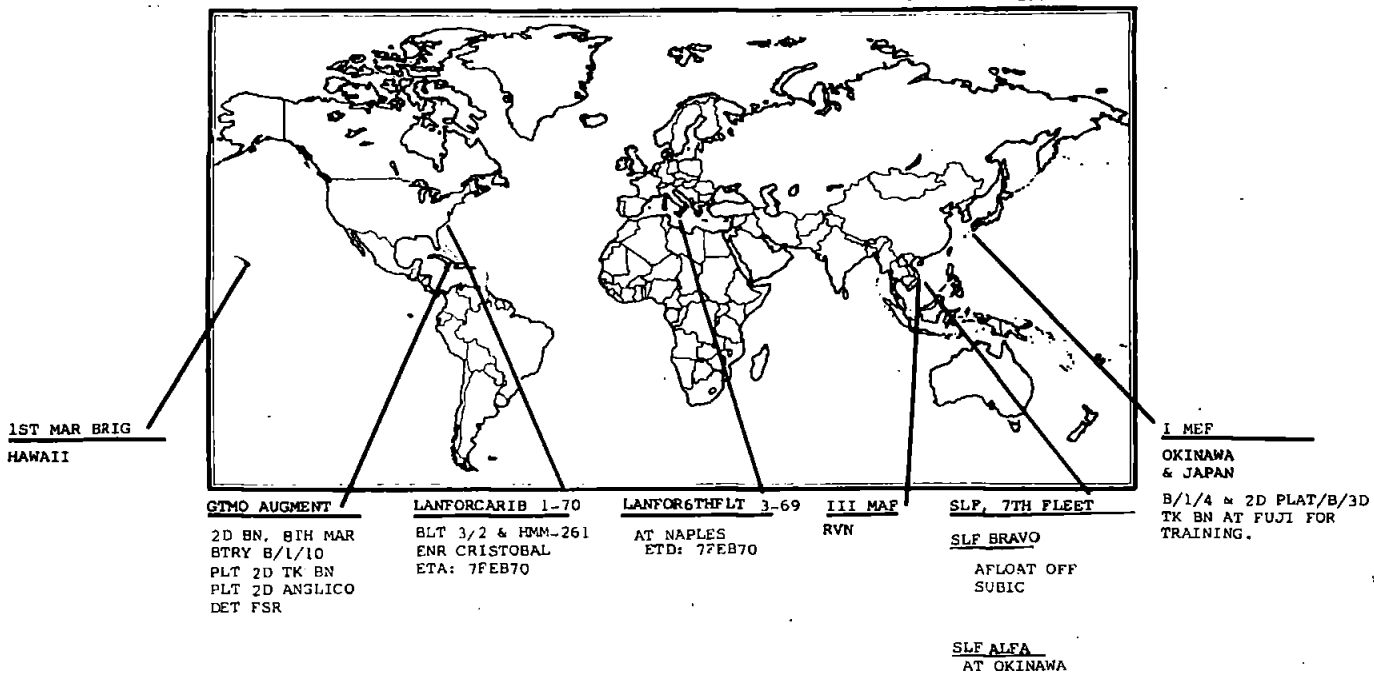

DISTRIBUTION OF MAJOR FMF UNITS

	INF BNS	YMFA	YMA	YMA(AW)	YMCJ	BMW	BMH	RML	YMO	YMGK
WESTPAC	18	5	2	3	1	6	2	2	2	1
RVN	(12)	(3)	(2)	(2)	(1)	(4)	(1)	(2)	(1)	
OKINAWA/JAPAN	(4)	(2)		(1)			(1)		(1)	(1)
ASSIGNED TO SLF	(2)					(2)				
MIDPAC	1	2								
HAWAII	(1)	(2)								
AFLOAT										
EASTPAC	2	3	2		1	2	2	1		1
WEST COAST	(2)	(3)	(2)		(1)	(2)	(2)	(1)		(1)
AFLOAT										
ATLANTIC	8	5	2	3	1	4	2		1	1
EAST COAST	(6)	(5)	(2)	(3)	(1)	(3)	(2)		(1)	(1)
CARIBBEAN	(2)					(1)				
EUROPE	1									
MEDITERRANEAN	(1)									
GRAND TOTAL	30	15	6	6	3	12	6	3	3	3

UNCLASSIFIED

UNCLASSIFIED

DISTRIBUTION OF PERSONNEL

FLEET MARINE FORCE, PACIFIC

4 FEBRUARY 1970

UNIT	NOTE	ASSIGNED STRENGTH		STRENGTH RPT DATE	DANANG		CHU LAI		PHU BAI		No I CTZ		OKINAWA		JAPAN		HAWAII		EASTPAC		OTHER		
		USMC	USN		USMC	USN	USMC	USN	USMC	USN	USMC	USN	USMC	USN	USMC	USN	USMC	USN	USMC	USN	USMC	USN	USMC
1ST BRIG																							
MAG-24																							
H&MS-24																							
MABS-24																							
MACS-2																							
MATCU-70																							
VMFA-212																							
VMFA-235																							
3D MAW																							
MWHG-3																							
H&HS-3																							
MWFS-3																							
MWCS-3																							
MCCRTG-10																							
H&MS-10																							
VNAT-102																							
VMT-103																							
MHTG-30																							
H&MS-30																							
HMHT-301																							
HMHT-302																							
MAG-33																							
VMA-223																							
H&MS-33																							
MABS-33																							
MATCU-65																							
VMCJ-3																							
VMA-214																							
VMFA-531																							
VMFA-323																							
VMPAT-101																							
VMFA-542																							
MMSG-37																							
H&MS-37																							
WERS-37																							
VMGR-352																							
MACG-38																							
H&HS-38																							
MACS-1																							
MACS-3																							
MACS-7																							
1ST LAAM BN																							
2ND LAAM BN																							
MAG-56																							
H&MS-56																							
MABS-56																							
MATCU-74																							
HMM-163																							
HML-267																							
HMM-265																							
HMH-363																							
MATCU-75																							
HMH-361																							
DET H&MS-11																							
DET H&MS-16																							
USMC																							
USN																							
AVIATION TOTAL																							

RECAPITULATION OF FMFPAC PERSONNEL DISTRIBUTION

		ASSIGNED STRENGTH	DANANG	CHU LAI	PHU BAI	No I CTZ	OKINAWA	JAPAN	HAWAII	EASTPAC	OTHER
GROUND TOTAL	USMC	78,919	38,541	1,569	365	987	17,061	295	3,764	12,816	3,521
	USN	3,476	1,721	21	0	19	980	0	165	414	156
AVIATION TOTAL	USMC	29,091	6,787	3,207	638	0	1,907	2,864	1,533	11,777	378
	USN	463	122	71	3	0	23	38	26	172	8
GRAND TOTAL	USMC	108,010	45,328	4,776	1,003	987	18,968	3,159	5,297	24,593	3,899
	USN	3,939	1,843	92	3	19	1,003	38	191	586	164

- NOTES:
- FIGURES IN "OTHER" ASSIGNED TO SLF'S.
 - FIGURES IN "OTHER" ASSIGNED TO VARIOUS LOCATIONS IN RVN.
 - PERSONNEL IN "OTHER" ARE ASSIGNED TO IT, IIT, SSC, CI TEAMS, RED EYE AND NUCLEAR ORDNANCE PLATOONS.
 - STRENGTH INCLUDED IN 1ST AND 3D TANK BATTALIONS.
 - THE 597 PERSONNEL LISTED IN "OTHER" ARE HOSPITALIZED AT LOCATIONS OTHER THAN OKINAWA, BUT ARE CARRIED ON THE ROLLS OF CASUAL COMPANY, MCB, CAMP BUTLER
 - AT SUBIC
 - * UNLESS OTHERWISE NOTED, STRENGTHS AND LOCATION ARE THOSE REPORTED BY UNIT PERSONNEL STATUS REPORTS AND DO NOT REFLECT DAY-TO-DAY ADJUSTMENTS BETWEEN PERIODS.
 - ** UNLESS OTHERWISE NOTED, STRENGTH REPORT DATE IS 16JAN70.
 - ENROUTE EASTPAC

Unclassified

UNCLASSIFIED

UNCLASSIFIED

SELECTED UNIT COMMANDERS AND STAFF OFFICERS

4 FEBRUARY 1970

1ST MARINE AIRCRAFT WING		3D MARINE AIRCRAFT WING	
COMMANDING GENERAL AWC	MGEN W. G. THRASH BGEN R. H. SPANJER	COMMANDING GENERAL AWC	MGEN R. G. OWENS, JR. BGEN J. A. FEELEY, JR.
CHIEF OF STAFF	COL R. W. TELLER	CHIEF OF STAFF	COL H. N. MEHAFFEY
ACOS, G-1	COL G. S. STEWART	ACOS, G-1	LTCOL L. A. GULLING
ACOS, G-2	COL J. R. WEAVER	ACOS, G-2	COL R. J. GRAHAM
ACOS, G-3	COL R. L. LAMAR	ACOS, G-3	COL D. WILKER
ACOS, G-4	COL W. C. MCGRAW	ACOS, G-4	
ACOS, COMPT	COL E. J. ARTNAK		
CEO	LTCOL T. KALUS		
<u>MWHG-1</u>		<u>MWHG-3</u>	
COMMANDING OFFICER	COL L. J. STIEN	COMMANDING OFFICER	COL G. L. LILLICH
H&MS-1	MAJOR H. F. WITTER	H&MS-3	LTCOL J. B. LLEVELLE
MWFS-1	LTCOL N. F. SCHNIPPEL, JR.	MWFS-3	MAJOR J. S. LOOP
MWCS-1	MAJOR A. B. RAY	MWCS-3	MAJOR D. B. NEWTON
<u>MWSG-17</u>		<u>MHTG-30</u>	
COMMANDING OFFICER	COL R. A. SAVAGE	COMMANDING OFFICER	COL A. F. GARROTTO
H&MS-17	LTCOL D. SERRIN	H&MS-30	LTCOL R. W. CREIGHTON
WERS-17	MAJOR W. F. FARLEY	HMHT-301	LTCOL L. W. JARMAN
		HMMT-302	LTCOL K. D. VANEK
<u>MAG-18</u>		<u>MAG-33</u>	
COMMANDING OFFICER	COL S. G. DUNWIDDIE, JR.	COMMANDING OFFICER	COL F. N. PIPPIN
H&MS-18	LTCOL H. E. HOPPEYER, JR.	H&MS-33	LTCOL R. H. HUTCHINSON
M&CS-4	LTCOL R. W. HOLYNEUX, JR.	M&BS-33	MAJOR J. E. KEHRLE
		VMCJ-3	LTCOL R. F. PERCIVAL
MASS-3	LTCOL J. H. DUBOTS	VMA-214	LTCOL W. R. SMITH
		VMFA-323	MAJ K. A. ZIMMERMAN II
<u>MAG-11</u>		VMFAT-101	LTCOL R. W. KRON
COMMANDING OFFICER	COL N. E. HEFFERNAN	VMFA-531	LTCOL J. L. THATCHER
H&MS-11	LTCOL R. F. HEBERT	VMFA-542	LTCOL K. A. SMITH
M&BS-11	LTCOL P. A. MANNING	VMA-223	LTCOL J. W. IAZZO
VMCJ-1	LTCOL B. W. FARLEY		
VMA(AW)-225	LTCOL J. J. METZKO	<u>MWSG-37</u>	
VMA(AW)-242	LTCOL S. P. LEWIS	COMMANDING OFFICER	COL F. E. WILSON
VMO-2	LTCOL J. M. MORIARITY	H&MS-37	LTCOL D. L. RICE
		WERS-37	LTCOL R. W. DUFFINEY
<u>MAG-12</u>		VMGR-352	LTCOL H. D. STOTT
COMMANDING OFFICER	COL P. B. HENLEY	<u>MAG-38</u>	
H&MS-12	LTCOL J. J. WENT	COMMANDING OFFICER	LTCOL T. I. GUNNING
M&BS-12	LTCOL G. J. ERTLMEIR	H&MS-38	MAJOR F. L. HARDING
VMA-311	MAJOR A. R. HICKLE	SU#1, H&MS-38	MAJOR D. V. STOWELL
VMA-211	LTCOL L. GASPERINE, JR.	M&CS-1	MAJ C. F. KELLENBARGER
VMA-223	LTCOL J. W. IAZZO	M&CS-3	LTCOL T. M. KAUFFMAN
		M&CS-7	LTCOL D. E. ROBERTS
<u>MAG-13</u>		1STLAAM BN	MAJOR E. L. HOUSE, JR.
COMMANDING OFFICER	LTCOL T. E. MURPHREE	2NDLAAM BN	MAJOR H. J. BALDWIN, JR.
H&MS-13	MAJOR F. J. HORAK, JR.	<u>MAG-56</u>	
M&BS-13	MAJOR R. D. REVIE	COMMANDING OFFICER	COL M. D. PORTER
VMFA-115	LTCOL D. P. BOWEN	H&MS-56	LTCOL G. H. BUCKNER II
VMFA-314	LTCOL T. J. KELLY	M&BS-56	LTCOL F. L. YOHE
VMFA-122	LTCOL R. E. HOWARD, JR.	HMH-363	LTCOL R. P. BRAY
		HML-267	LTCOL J. M. BLANC
<u>MAG-16</u>		HMH-361	LTCOL K. W. ANDRUS
COMMANDING OFFICER	COL J. P. BRUCE	HMM-163	LTCOL F. A. MATHEWS
H&MS-16	MAJOR M. T. HORNSBY	HMM-265	LTCOL R. G. COUNTRY
M&BS-16	LTCOL P. C. SCAGLIONE	<u>MCCRTG-10</u>	
HMH-463	LTCOL C. A. BLOCK	COMMANDING OFFICER	COL G. FINK
HML-167	LTCOL J. E. WEBER	H&MS-10	MAJ I. L. DRIEFER
HMM-364	LTCOL C. R. DUNBAUGH	VMAT-102	LTCOL B. A. SCHAFFER
HMM-263	LTCOL W. R. LEDBETTER	VMT-103	LTCOL M. T. GARRISON
HMM-161	MAJOR B. H. MANN		
HMM-262	LTCOL R. A. BANCROFT		
HML-367	LTCOL W. G. CRETNEY		

UNCLASSIFIED

Unclassified

MARINE CORPS COMMAND CENTER

UNCLASSIFIED

DISTRIBUTION OF MAJOR FMFPAC TACTICAL UNITS

4 FEBRUARY 1970

UNIT	CHU LAI	DANANG	NoICTZ/DMZ	OKINAWA	JAPAN	HAWAII	EASTPAC	OTHER	NOTE
1ST MARINES		1/1, 2/1, 3/1							
3D MARINES						1/3	2/3, 3/3		
4TH MARINES				1/4, 2/4, 3/4					
5TH MARINES		1/5, 2/5, 3/5							
7TH MARINES		1/7, 2/7, 3/7							
9TH MARINES				3/9				1/9, 2/9	1
26TH MARINES		1/26, 2/26, 3/26							
MAG-11		VMCJ-1 VMA(AW)-225 VMA(AW)-247 VMO-2							
MAG-12	VNA-211 VMA-311								
MAG-13	VMFA-115 VMFA-314 VMFA-122								
MAG-16		HML-167 HML-163 HMM-263 HMM-364	HMM-161 HML-367 HMM-262						
MAG-36				HMM-462 VMO-6				HMM-164 HMM-165	1 1
MAG-15						VMFA-232 VMFA-334 VMA(AW)-533			
MAG-24						VMFA-212 VMFA-235			
MAG-33							VMA-223 VMCJ-3 VMA-214 VMFA-323 VMFA-531 VMFA-542		2
MAG-56							HML-267 HML-363 HMM-163 HMM-361 HMM-265		2

DISTRIBUTION OF MAJOR GROUND EQUIPMENT

EQUIPMENT	T/E AUTH	CHU LAI	DANANG	NoICTZ/DMZ	OKINAWA	HAWAII	EASTPAC	OTHER	NOTE
60mm MORTAR M19	254		144		60	12	24	12	1
81mm MORTAR M29	168		96		40	8	16	8	1
106mm RR M40A1C	168		96		40	8	16	8	1
107mm MORTAR M30	42		24		6	6		6	1
105mm HOW TD M101A1	136		72		30	6	12	6	1
155mm HOW SP M109	42		24		12		6		
175mm GUN (SP)	18		12	6					
81n HOW SP M110	14		12	2					
ONTOS M50A1	115		15		75		15	10	1
90mm TANK M48A3	126		73		36		17		
120mm TANK M103A2	17						17		
FLAME TANK M67A2	27		12		9		6		
LVTH6	18		6		12				
LVTP5	280		112		113		44	11	1
LVTE1	24		8		8		8		
HAWK LAUNCHERS	36						36		

NOTES: 1. UNITS/EQUIPMENT IN OTHER ASSIGNED TO SLF's.
2. ENROUTE CONUS.
3. ENROUTE OKINAWA.

Unclassified

UNCLASSIFIED

~~CONFIDENTIAL~~
UNCLASSIFIED

DISTRIBUTION OF AIRCRAFT, FMFPAC

4 FEBRUARY 1970

UNIT	DAWANG	CBU LAI	PHU BAI	OKINAWA	JAPAN	HAWAII	EASTPAC	OTHER
HQ SODN, FMFPAC						6/T-1A 1/C-54R 1/C-47J		
MAG-11 H&MS-11	8/TA-4F 1/C-117D							
VMCJ-1	9/RF-4B							
VMA(AW)-242	8/EA-6A							
VMA(AW)-225	12/A-6A							
VMO-2	11/A-6A 23/AH-1G 19/OV-10A							
MAG-12 H&MS-12		1/C-117D						
VMA-211		19/A-4E						
VMA-311		19/A-4E						
MAG-13 H&MS-13		1/C-117D						
VMFA-115		14/F-4B						
VMFA-314		15/F-4B						
VMFA-122		11/F-4B						
MAG-15 H&MS-15					1/C-54Q 1/C-117D 3/TA-4F 1/C-54S 14/F-4J			
VMFA-232					12/F-4J			
VMFA-334					11/A-6A			
VMA(AW)-533								
MAG-16 H&MS-16	1/C-117D		1/C-117D 1/CH-46A					
HML-167	25/UH-1E							
HML-367			24/UH-1E					
HMM-263	21/CH-46D							
HMM-161			21/CH-46D					
HMM-262			21/CH-46D					
HMM-364	20/CH-46D							
HMH-462	21/CH-53A/D							
MCCRTG-10 H&MS-10								
VMAT-102							26/A-4C	
VMT-103							16/TA-4F	
MWSG-17 H&MS-17	3/US-2B 3/C-117D							
MHTG-30 H&MS-30							5/CH-46D	
HMHT-301							14/CH-53A	
HMHT-302							18/CH-46D	
MAG-33 H&MS-33							2/F-4B 6/TA-4F	
VMA-223 VNCJ-3							20/A-4E 8/RF-4B 1/F-4B 12/EF-10B 23/A-4C	**
VMA-214							12/F-4B	
VMFA-323							23/F-4B	
VMFA-531							15/F-4B	**
VMFAT-101								
VMFA-542								
MAG-36 H&MS-36				1/C-117D 1/CH-46A 12/KC-130F				
VMGR-152								18/CH-46A
HMM-165								19/CH-46A
HMM-164								
HMH-462				20/CH-53A				
VMO-6				11/UH-1E 18/OV-10A				

NOTES: * ASSIGNED TO SLF's
** ENROUTE CONUS

~~CONFIDENTIAL~~
UNCLASSIFIED
Unclassified

~~SECRET~~

UNCLASSIFIED

MARINE CORPS COMMAND CENTER

MARINE CORPS PERSONNEL IN RVN

4 FEBRUARY 1970

	OFF	ENL	TOTAL
* III MAF.	3,717	50,508	54,225
DANANG	(3,159)	(43,662)	(46,821)
CHU LAI	(395)	(4,888)	(5,283)
PHU BAI	(126)	(1,211)	(1,337)
DONG HA	(37)	(747)	(784)
SU #1, 1ST ANGLICO (AT VARIOUS LOCATIONS SVN)	((22))	((192))	((214))
OTHER USMC PERSONNEL	160	152	312
MACV STAFF/MACV FIELD	(136)	(139)	(275)
NAVAADVGRU/NAVY UNITS	(24)	(13)	(37)
USMC IN RVN CHARGED AGAINST PROGRAM VIII	3,877	50,660	54,537
U. S. NAVY, III MAF.	267	1,916	2,183

* AS REPORTED BY III MAF DAILY ADMIN SITREP # 0028 AS OF 2400, 27JAN70 AND ADJUSTED IN ACCORDANCE WITH MACV WEEKLY STRENGTH REPORT AND DAILY MACV REPORTS OF ARRIVALS/DEPARTURES AS OF 2400 2FEB70.

Unclassified

UNCLASSIFIED
~~SECRET~~

UNCLASSIFIED

MARINE CORPS COMMAND CENTER

WESTPAC UNIT LOCATIONS

4 FEBRUARY 1970

QUANG TRI (QUANG TRI CITY)		USMC	784	USMC RVN RECAP	
1ST BDE, 5TH INF DIV (MECH)		USN	39 *	OSD PROGRAM VIII CEILING	55,510 2,233
1/77 ARMOR (OPN GREEN RIVER)		USA	5,800	ACTUALS CHARGED AGAINST PROGRAM VIII AS OF 2FEB70	54,537 2,183
1/61 INF (MECH) (OPN GREEN RIVER)				III MAF	54,225 2,183 #
1/11 INF (OPN GREEN RIVER)				SU#1, 1ST ANGLICO	((214)) ((14))
3/5 ARMD CAV SQDN (OPN GREEN RIVER)				MACV STF/MACV FLD	(275)
				NAVAJNGRU/NAVY UNITS.	(37)
THUA THIEN HQ, XXIV CORPS (PHU BAI)		USMC	1,337	I CORPS RECAP	
HQ, 101st ABN DIV (AM)		USN	44 *	US MARINE CORPS.	(12 BNs) 54,225
1ST BDE, 101ST ABN DIV (AM)		USA	26,050	US ARMY	(25 BNs) 73,849
1/327 INF (AM) (OPN RANDOLPH GLEN)				US NAVY	17,097
2/327 INF (AM) (OPN RANDOLPH GLEN)				US AIR FORCE	8,194
2/502 INF (AM) (OPN RANDOLPH GLEN)				ROKMC	(4 BNs) 7,145
2D BDE, 101ST ABN DIV (AM)				RVNAF	(36 BNs) 149,640
1/501 INF (AM) (OPN RANDOLPH GLEN)				ARVN/ABN.	(36 BNs) (73,607)
2/501 INF (AM) (OPN RANDOLPH GLEN)				VNMC.	
1/502 INF (AM) (OPN RANDOLPH GLEN)				VNN	(2,092)
3D BDE, 101ST ABN DIV (AM)				VNAF	(3,416)
1/506 INF (AM) (OPN RANDOLPH GLEN)				VNRF.	(36,339)
2/506 INF (AM) (OPN RANDOLPH GLEN)				VNPF.	(34,186)
3/187 INF (AM) (OPN RANDOLPH GLEN)				I CORPS TOTAL	77 BNs 310,150
QUANG NAM HQ, III MAF		USMC	46,821	SLF 7TH FLEET	
HQ 1st MAR DIV (DANANG)		USN	1,970 *	BRAVO: BLT 2/9	1,847 60
1ST MARINES		USA	1,058	HMM-165	
1/1				AFLOAT OFF SUBIC	
2/1				ALFA: BLT 1/9	1,868 85
3/1				HMM-164	
5TH MARINES				AT OKINAWA	
1/5					
2/5					
3/5					
7TH MARINES					
1/7					
2/7					
3/7					
26TH MARINES					
1/26					
2/26					
3/26					
QUANG TIN/QUANG NGAI HQ 23d INF DIV (AMERICAN) (CHU LAI)		USMC	5,283	MOVEMENTS	
196TH LT INF BDE		USN	130 *	B/1/4 & 2D Plat/B/3D Tk Bn at Fuji for training.	
2/1 INF (OPN FREDERICK HILL)		USA	24,106	Det 12THMAR and "D" Co, 3D Recon at Namazu.	
4/31 INF (OPN FREDERICK HILL)					
3/21 INF (OPN FREDERICK HILL)					
1/46 INF					
198TH LT INF BDE					
1/6 INF (OPN GENEVA PARK)					
1/52 INF (OPN GENEVA PARK)					
5/46 INF (OPN NANTUCKET BEACH)					
11TH INF BDE					
1/20 INF (OPN IRON MOUNTAIN)					
4/21 INF (OPN IRON MOUNTAIN)					
3/1 INF (OPN IRON MOUNTAIN)					
4/3 INF (OPN IRON MOUNTAIN)					
1/1 ARMD CAV SQDN (OPN IRON MOUNTAIN)					
OKINAWA HQ, I MEF 3D MAR DIV (-) (REIN)		USMC	19,200	JAPAN	
OSD PROGRAM VIII CEILING		USN	934	OSD PROGRAM VIII CEILING	3,600 45
ACTUALS CHARGED AGAINST PROGRAM VIII AS OF 15JAN70.			424	ACTUALS CHARGED AGAINST PROGRAM VIII AS OF 15JAN70.	3,455* 34
4TH MARINES				1ST MAW (REAR)	
1/4				MAG-15	(2,244) (34)
2/4				VMFA-232 (F-4J)	
3/4				VMFA-334 (F-4J)	
9TH MARINES				VMA(AW)-533 (A-6A)	
3/9					
MAG-36			(13,989)		
VMGR-152 (KC-130F)					
VMO-6 (OV-10A/UH-1E)					
HMH-462 (CH-53A)					
3D FSR			(3,175)		
MCB CAMP BUTLER/NON FMF			(920)		
Non-Deployable Casuals			(171)		
SVN-Originated Patients			(0)		

* Includes only U. S. Navy Personnel organic to FMF Units.
 # Includes SU#1 and 1st ANGLICO at various locations throughout SVN.
 • Latest Change

Unclassified (1,211)

UNCLASSIFIED

MARINE CORPS
1 FEB 4 1970
REFERENCE BRANCH

Unclassified

SUMMARY OF MAJOR US AND FWMAF OPERATIONS

OPERATION (DATE COMMENCED)	UNITS INVOLVED	LOCATION	CASUALTIES AS OF: 042400H FEB70		
			FRIENDLY		ENEMY
			KIA	WIA	KIA.
GREEN RIVER (19JAN70)	1ST BDE, 5TH INF DIV (MECH): 4 USA BNS	EASTERN QUANG TRI PROVINCE	2	61	23
RANDOLPH GLEN (7DEC69)	101ST ABN DIV (AM): 9 USA BNS	QUANG TRI & THUA THIEN PROVINCES	40	220	321
VICTORY DRAGON XIX (1JAN70)	2D ROKMC BDE: 2 BNS	HOI AN AREA	NONE	9	9
VICTORY DRAGON XIX-1 (25JAN70)	2D ROKMC BDE: 1 BN	HOI AN AREA	NONE	7	36
VICTORY DRAGON XIX-21 (31JAN70)	2D ROKMC BDE: 1 BN	HOI AN AREA	1	2	1
FREDERICK HILL (18MAR69)	196TH INF BDE: 3 USA BNS	QUANG TIN PROVINCE	366	2,289	4,394
GENEVA PARK (18JUL69)	198TH INF BDE: 2 USA BNS	QUANG TIN & QUANG NGAI PROVINCES	125	843	1,119
NANTUCKET BEACH (20JUL69)	198TH INF BDE: 1 USA BN	CENTERED 15 KM NE OF QUANG NGAI CITY	23	198	240
IRON MOUNTAIN (18MAR69)	11TH INF BDE: 5 USA BNS	QUANG NGAI PROVINCE	287	1,628	2,429

* - ADJUSTED
- FINAL CUMULATIVE CASUALTIES

UNCLASSIFIED

Unclassified

UNCLASSIFIED

MARINE CORPS COMMAND CENTER

USMC/ENEMY CASUALTIES IN RVN

4 FEBRUARY 1970

USMC BATTLE CASUALTIES

KIA/DOW	WIA(EVAC)	WIA(RTD)	MIA/PW
12,423	48,725	35,729	83/21

USMC CASUALTY FIGURES ARE PROVIDED DAILY BY HQMC CASUALTY SECTION (CODE DNA) AND REFLECT ALL CASUALTIES REPORTED AS OF 3FEB70

USMC NON-BATTLE CASUALTIES

DEAD	INJURED	MISSING
1,497	1,818	8

FIGURES INDICATED AS INJURED ARE ONLY THOSE IN SERIOUS/CRITICAL INJURY OR DISEASE CATEGORY AND DO NOT INCLUDE THOSE OF A MINOR NATURE

USMC INFLECTED ENEMY CASUALTIES

KIA	PW	WPNS
80,171	4,115	20,622

ENEMY CASUALTIES ARE COMPILED DAILY FROM THE III MAF HISSUM AND ARE RECONCILED MONTHLY WITH THE FMFPAC SUMMARY OF USMC OPERATIONS IN RVN

TYPICAL DISPOSITION OF 100 USMC WIA *

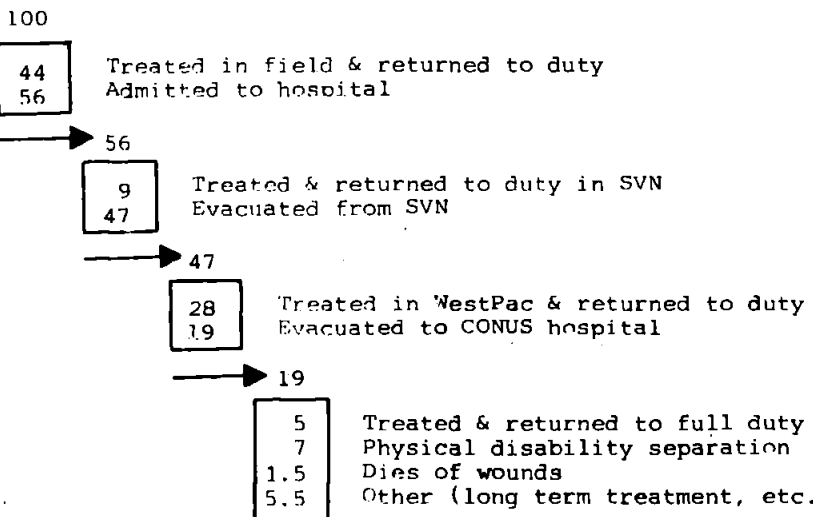

UNCLASSIFIED

*54,081 CASUALTIES, JAN67-DEC68.

Unclassified

~~CONFIDENTIAL~~

MARINE CORPS COMMAND CENTER

SPECIAL LANDING FORCE, 7TH FLEET

UNCLASSIFIED

SLF BRAVO

4 FEBRUARY 1970

TASK GROUP 79.4 CTG: COL G. G. CHAMBERS JR	STRENGTH				ARMS & EQUIPMENT	LOCATION
	USMC		USN			
UNITS EMBARKED	OFF	ENL	OFF	ENL		
SLF HQS DET					8 M29 81MM MORTARS 3 M40 106MM RR 6 M30 107MM MORTARS 4 M101A1 105MM HOW 4 M48 90MM TANKS 5 LVTP-5 AIRCRAFT 18/CH-46A	AFLOAT OFF SUBIC SHIPPING USS NEW ORLEANS (LPH-11) USS THOMASTON (LSD-28) USS VANCOUVER (LPD-2) USS WHITFIELD CTY (LST-1169) SUPPLIES CLASS I CLASS II CLASS III CLASS IV CLASS V
BLT 2/9 (LTCOL J. R. VANDENELZEN) 2D BN, 9TH MARINES W/2/12 E/2/12 PLAT, CO "B", 1ST AMTRAC PLAT, CO "C", 3D ENGR BN PLAT, CO "C", 3D SP BN PLAT, CO "C", 3D MT BN PLAT, CO "C", 3D RECON BN PLAT, CO "A", 3D TK BN CLEAR PLAT, CO "B", 3D MED SQD, MP CO, 3D MARDIV DET, HOBN, 3D MARDIV DET, COMM PLT, HQCO, 9TH MAR DET, COMM SPT CO, 7TH COMM DET, 3D DENTAL CO LSU	52	1500	1	56		
HMM-165 (LTCOL P. H. MITCHELL)	69	226	1	2		
TOTALS	121	1726	2	58		

SLF ALFA

28 JANUARY 1970

TASK GROUP 79.5 CTG: COL C. W. BOYD, JR.	STRENGTH				ARMS & EQUIPMENT	LOCATION
	USMC		USN			
UNITS EMBARKED	OFF	ENL	OFF	ENL		
SLF HQS DET					12 M10 60MM MORTARS 8 M29 81MM MORTARS 3 M40 106 MM RR 6 M30 107 MM MORTARS 6 M101A1 105 MM HOW 5 M48 90MM TANKS AIRCRAFT 19 /CH-46A's	AT OKINAWA SHIPPING SUPPLIES CLASS I 30 DAYS CLASS II 30 DAYS CLASS III 30 DAYS CLASS IV 30 DAYS CLASS V 30 DAYS
BLT 1/9 (LTCOL D. J. MC ADAMS) 1ST BN, 9TH MARINES MORT BTRY, 2/12 BTRY "D" (REIN), 2/12 PLAT, CO "B", 1ST AMTRAC BN PLAT, CO "C", 3D ENGR BN PLAT, CO "C", 3D SP BN PLAT, CO "A", 3D MT BN PLAT, CO "C", 3D RECON BN PLAT, CO "C", 3D TK BN CLEAR PLT, CO "B", 3D MED BN SQD, MP CO, 3D MARDIV DET, HQ BN DET, COMM PLT HQ CO, 9TH MAR DET, 3D DENTAL CO LSU DET EMU NBG	54	1596	6	76		
HMM-164 (LTCOL R. D. FOWNER)	41	177	1	2		
TOTALS	95	1773	7	78		

~~CONFIDENTIAL~~

UNCLASSIFIED

Unclassified

UNCLASSIFIED
~~CONFIDENTIAL~~

MARINE CORPS COMMAND CENTER

MILITARY FORCES IN RVN *

4 FEBRUARY 1970

RVN ARMED FORCES (RVNAF)

ARMY (ARVN)	420,000
NAVY (VNN)	31,500
AIR FORCE (VNAF)	35,600
MARINE CORPS (VNMC)	11,900
REGIONAL FORCES (RF)	258,500
POPULAR FORCES (PF)	216,500
TOTAL RVNAF	974,000

UNITED STATES FORCES

ARMY	330,896
NAVY	29,784
AIR FORCE	57,384
MARINE CORPS	54,537
COAST GUARD	383
TOTAL U.S.	472,984

FREE WORLD MILITARY ASSISTANCE FORCES (FWMAF)

REPUBLIC OF KOREA	48,860
AUSTRALIA	7,694
PHILIPPINES	143
THAILAND	11,568
NEW ZEALAND	556
REPUBLIC OF CHINA	29
SPAIN	10
TOTAL FWMAF	68,860

TOTAL FORCES IN RVN 1,515,844

SOURCE: RVNAF MACV MONTHLY GIVEN FORCES STRENGTH DATA REPORT.

ALL OTHER, MACV WEEKLY STRENGTH REPORT AS OF 2400,
22JAN70 USMC STRENGTH: MACV WK STRENGTH REPORT AS
ADJUSTED BY MACV REPORT OF ARR/DEP AS OF 2400, 2FEB70.

UNCLASSIFIED
~~CONFIDENTIAL~~

UNCLASSIFIED

CINCPAC
VIETNAM & THAILAND - AIR FORCE

4 FEBRUARY 1970

<u>VIETNAM AIR FORCE</u>	
<u>BAN ME THOUT</u>	
UH-1	6
<u>BIEN HOA</u>	
F-100	19
A-37	64
O-1	58
O-2	85
OV-10	45
UC-123	14
C-7	1
C-47	2
HH-43	2
<u>CAM RANH BAY</u>	
F-4	36
C-7	28
C-130	49
HH-43	2
O-1	25
O-2	63
RC-130	3
<u>DA NANG</u>	
F-4	45
O-2	81
OV-10	38
HH-3	13
HH-43	2
C-47	1
A-1	10
AC-119	5
<u>NHA TRANG</u>	
C-123	4
C-130	3
<u>PHAN RANG</u>	
F-100	69
C-123	43
HH-43	2
AC-119	11
<u>PHU CAT</u>	
EC-47	12
C-7	26
F-4	34
HH-43	1
AC-119	3
<u>PLEIKU</u>	
EC-47	14
HH-43	2
<u>TAN SON NHUT</u>	
RF-4	34
C-123	17
RB-57	4
RF-101	14
C-130	16
HH-43	2
EC-47	17
AC-119	5
<u>TUY HOA</u>	
F-100	83
HC-130	11
HH-43	2
C-47	3
O-2	13
AC-119	4
UH-1	6
<u>VUNG TAU</u>	
C-7	30

<u>THAILAND AIR FORCE</u>	
<u>BANGKOK</u>	
F-102	4
C-130	5
<u>KORAT</u>	
F-4	34
HH-43	2
EC-121	27
C-121	1
<u>NAKHOM PHANOM</u>	
UC-123	5
C-123	4
A-1	62
O-2	12
OV-10	20
HH-3	4
CH-3	7
EC-47	6
<u>TAKHLI</u>	
F-105	72
EB-66	18
HH-43	2
<u>UBON</u>	
F-4	79
C-130	8
HH-43	3
AC-130	7
OV-10	10
AC-123	2
<u>UDORN</u>	
RF-4	37
AC-47	3
F-4	36
HH-43	3
HH-53	5
C-130	6
CH-3	4
<u>U-TAPAO</u>	
HH-43	2

27-1

UNCLASSIFIED

Unclassified

~~CONFIDENTIAL~~

UNCLASSIFIED
SELECTED

MARINE CORPS COMMAND CENTER

PERSONNEL AND AIRCRAFT DATA

PERSONNEL

5 FEBRUARY 1970

	STRENGTH	PERCENT USMC	PERCENT FMF	PERCENT FMPAC
USMC TOTAL	300,982 *	100.00		
FLEET MARINE FORCES	150,437	49.99	100.00	
FMF ATLANTIC	42,404 \$	14.09	28.19	
FMF PACIFIC	108,033 #	35.90	71.81	
VIETNAM	54,519 †	18.11	36.24	50.47

SOURCE: * MONTHLY USMC PERSONNEL ALLOCATION REPORT OF 30NOV69.
 \$ MCCC UNIT REPORT OF 24DEC69.
 # MCCC UNIT REPORT OF 21JAN70.
 † MACV WEEKLY STRENGTH REPORT AS OF 2400, 15JAN70 AS ADJUSTED BY MACV REPORT OF ARR/DEPART AS OF 2400, 3FEB70.

AIRCRAFT

10 JANUARY 1970

	FIXW	HELO	TOTAL	PERCENT USMC	PERCENT FMF	PERCENT FMPAC
USMC TOTALS	1013	569	1582	100.00		
FLEET MARINE FORCES	763	543	1306	82.55	100.00	
FMF ATLANTIC	303	156	459	29.01	35.15	
FMF PACIFIC	460	387	847	53.54	64.85	
VIETNAM	156	178	334	21.11	25.57	39.43

SOURCE: MARINE CORPS COMMAND CENTER UNIT REPORT OF 31DEC69.

UNCLASSIFIED
 Unclassified
~~CONFIDENTIAL~~

FLEET MARINE FORCE DEPLOYMENTS

5 FEBRUARY 1970

UNCLASSIFIED



1ST MAR BRIG
HAWAII

I MEF
OKINAWA
& JAPAN

GTMO AUGMENT
2D BN, 8TH MAR
BTRY B/L/10
PLT 2D TK BN
PLT 2D ANGLICO
DET FSR

LANFORCARIB 1-70
BLT 3/2 & HMM-261
ENR CRISTOBAL
ETA: 7FEB70

LANFOR6THFLT 3-69
AT NAPLES
ETD: 7FEB70

III MAF
RVN

SLF, 7TH FLEET
SLF BRAVO
AFLOAT OFF
SUBIC

B/1/4 & 2D PLAT/B/3D
TK BN AT FUJI FOR
TRAINING.

SLF ALFA
AT OKINAWA

DISTRIBUTION OF MAJOR FMF UNITS

	INF BNS	VMFA	VMA	VMA(AW)	VMCJ	HMM	HMH	HML	VMO	VMSR
WESTPAC	18	5	2	3	1	6	2	2	2	1
RVN	(12)	(3)	(2)	(2)	(1)	(4)	(1)	(2)	(1)	
OKINAWA/JAPAN	(4)	(2)		(1)			(1)		(1)	(1)
ASSIGNED TO SLF's	(2)					(2)				
MIDPAC	1	2								
HAWAII	(1)	(2)								
AFLOAT										
EASTPAC	2	* 3	2		1	2	2	1		1
WEST COAST	(2)	(3)	(2)		(1)	(2)	(2)	(1)		(1)
AFLOAT										
ATLANTIC	8	5	2	3	1	4	2		1	1
EAST COAST	(6)	(5)	(2)	(3)	(1)	(3)	(2)		(1)	(1)
CARIBBEAN	(2)					(1)				
EUROPE	1									
MEDITERRANEAN	(1)									
GRAND TOTAL	30	15	6	6	3	12	6	3	3	3

* CA7RE

UNCLASSIFIED

UNCLASSIFIED

DISTRIBUTION OF PERSONNEL

FLEET MARINE FORCE, PACIFIC

5 FEBRUARY 1970

UNIT	NOTE	ASSIGNED STRENGTH		STRENGTH RPT DATE	DANANG		CHU LAI		PHU BAI		No I CTZ		OKINAWA		JAPAN		HAWAII		EASTPAC		OTHER		
		USMC	USN		USMC	USN	USMC	USN	USMC	USN	USMC	USN	USMC	USN	USMC	USN	USMC	USN	USMC	USN	USMC	USN	USMC
1ST BRIG																							
MAG-24																							
H&MS-24		455															455						
MABS-24		277	26														277	26					
MACS-2		187															187						
MATCU-70		35															35						
VMFA-212		263															263						
VMFA-235		255															255						
3D MAW																							
MWHG-3																							
H&HS-3		683	124																	683	124		
MWFS-3		165																		165			
MWCS-3		263																		263			
MCCRTG-10																							
H&MS-10		266	2																	266	2		
VMAT-102		206																		206			
VMT-103		182																		182			
MHTG-30																							
H&MS-30		371	1																	371	1		
HMHT-301		175	1																	175	1		
HMHT-302		207	1																	207	1		
MAG-33																							
VMA-223	7	167	1																	167	1		
H&MS-33		1017	2																	1017	2		
MABS-33		419	3																	419	3		
MATCU-65		62																		62			
VMCJ-3		405	1																	405	1		
VMA-214		208																		208			
VMFA-531		306	1																	306	1		
VMFA-323(CADRE)		10																		10			
VMFAT-101		468																		468			
VMFA-542	7	286	1																	286	1		
MWSG-37																							
H&MS-37		659	3																	659	3		
WERS-37		253	1																	253	1		
VMGR-352		377	1																	377	1		
MAG-38																							
H&HS-38		298	2																	298	2		
MACS-1		292	2																	292	2		
MACS-3		274																		274			
MACS-7		280	1																	280	1		
1ST LAAM BN		184																		184			
2ND LAAM BN		766	16																	766	16		
MAG-56																							
H&MS-56		461																		461			
MABS-56		423	2																	423	2		
MATCJ-74		93																		93			
HMM-163		300																		300			
HML-267		393	5																	393	5		
HMM-265		192																		192			
HMH-363		323																		323			
MATCU-75		53																		53			
HMH-361	7	202	1																	202	1		
DET H&MS-11	7	52	0																	52	0		
DET H&MS-16	7	36																		36			
USMC		29,091			6,787	3,374	638	0	1,907	2,864	1,533	11,610	378										
USN		463			122	71	3	0	23	38	26	171	8										
AVIATION TOTAL		29,554			6,909	3,446	641	0	1,930	2,902	1,559	11,781	386										

RECAPITULATION OF FMFPAC PERSONNEL DISTRIBUTION

		ASSIGNED STRENGTH	DANANG	CHU LAI	PHU BAI	No I CTZ	OKINAWA	JAPAN	HAWAII	EASTPAC	OTHER
GROUND TOTAL	USMC	78,919	38,541	1,569	365	987	17,061	295	3,764	12,816	3,521
	USN	3,476	1,721	21	0	19	980	0	165	414	156
AVIATION TOTAL	USMC	29,091	6,787	3,207	638	0	1,907	2,864	1,533	11,777	378
	USN	463	122	71	3	0	23	38	26	172	8
GRAND TOTAL	USMC	108,010	45,328	4,776	1,003	987	18,968	3,159	5,297	24,593	3,899
	USN	3,939	1,843	92	3	19	1,003	38	191	586	164

- NOTES:
- FIGURES IN "OTHER" ASSIGNED TO SLF'S.
 - FIGURES IN "OTHER" ASSIGNED TO VARIOUS LOCATIONS IN RVN.
 - PERSONNEL IN "OTHER" ARE ASSIGNED TO IT, ITP, SSC, CI TEAMS, RED EYE AND NUCLEAR ORDNANCE PLATOONS.
 - STRENGTH INCLUDED IN 1ST AND 3D TANK BATTALIONS.
 - THE 597 PERSONNEL LISTED IN "OTHER" ARE HOSPITALIZED AT LOCATIONS OTHER THAN OKINAWA, BUT ARE CARRIED ON THE ROLLS OF CASUAL COMPANY, MCB, CAMP BUTLER
 - AT SUBIC
 - UNLESS OTHERWISE NOTED, STRENGTHS AND LOCATION ARE THOSE REPORTED BY UNIT PERSONNEL STATUS REPORTS AND DO NOT REFLECT DAY-TO-DAY ADJUSTMENTS BETWEEN PERIODS.
 - UNLESS OTHERWISE NOTED, STRENGTH REPORT DATE IS 16JAN70.
 - ENROUTE EASTPAC

Unclassified

UNCLASSIFIED

MARINE CORPS COMMAND CENTER

SELECTED UNIT COMMANDERS AND STAFF OFFICERS

5 FEBRUARY 1970

UNCLASSIFIED

HEADQUARTERS III MARINE AMPHIBIOUS FORCE	
COMMANDING GENERAL	LTGEN H. NICKERSON, JR.
DEPUTY COMMANDER	MGEN G. S. BOWMAN, JR.
CHIEF OF STAFF	BGEN L. J. DULACKI
DEPUTY CHIEF OF STAFF	COL S. A. DRESSIN
ACOS, G-1	COL R. L. PARNELL, JR.
ACOS, G-2	COL E. W. DZIALO
ACOS, G-3	BGEN T. H. MILLER, JR.
ACOS, G-4	COL W. F. SIMLIK
ACOS, G-5	COL C. J. PEABODY
ACOS, G-6	LTCOL R. S. BARRY
ACOS, COMPT	LTCOL J. M. VOSMIK
DEP C/S SPECIAL PROJECTS	COL A. T. WOOD

DEP C/S XXIV CTZ	COL M. M. COOK
ACOS, CAP	COL T. E. METZGER
COMMANDING OFFICER, 1ST CAG	LTCOL D. F. SEILER
COMMANDING OFFICER, 2ND CAG	LTCOL E. LEWIS
COMMANDING OFFICER, 3RD CAG	LTCOL C. M. DANIELS
COMMANDING OFFICER, 4TH CAG	LTCOL J. J. KEENAN
1ST RADIO BATTALION	LTCOL D. M. HOPKINS

1ST MARINE DIVISION	FORCE LOGISTICS COMMAND
COMMANDING GENERAL	MGEN E. B. WHEELER
AIC	BGEN C. S. ROBERTSON
AIC	COL C. E. WALKER
CHIEF OF STAFF	COL R. E. BARDE
ACOS, G-1	COL E. A. WILCOX
ACOS, G-2	COL F. H. WALDROP
ACOS, G-3	COL N. A. CANZONA
ACOS, G-4	LTCOL V. A. ALBERS, JR.
ACOS, G-5	LTCOL N. M. LASLAVIC, JR.
ACOS, COMPT	COL C. G. DAHL
CEO	
<u>1ST MARINES</u>	
COMMANDING OFFICER	COL H. J. WILKERSON
1ST BATTALION	LTCOL G. S. DELCUZE
2ND BATTALION	LTCOL W. V. H. WHITE
3RD BATTALION	LTCOL F. M. BOYD
<u>5TH MARINES</u>	
COMMANDING OFFICER	COL N. L. BECK
1ST BATTALION	LTCOL J. K. GRIFFIS, JR.
2ND BATTALION	LTCOL J. J. BOWEN
3RD BATTALION	LTCOL J. S. GESTSON
<u>7TH MARINES</u>	
COMMANDING OFFICER	COL G. S. CODISPOTI
1ST MARINES	LTCOL F. A. CLARK
2ND MARINES	LTCOL A. E. FOLSOM
3RD MARINES	LTCOL R. G. KUMMEROW
<u>26TH MARINES</u>	
COMMANDING OFFICER	COL J. E. HARRELL
1ST BATTALION	LTCOL J. C. GOODIN
2ND BATTALION	LTCOL C. W. DRUMWRIGHT
3RD BATTALION	LTCOL J. J. UNTERKOPFLER
<u>11TH MARINES</u>	
COMMANDING OFFICER	COL D. D. EZELL
1ST BATTALION	LTCOL J. D. SHOUP
2ND BATTALION	LTCOL V. WEAVER
3RD BATTALION	LTCOL K. N. MUELLER
4TH BATTALION	LTCOL J. F. BURKE, JR.
1ST BN, 13TH MAR	LTCOL D. H. STRAIN
HQS BATTALION	COL W. C. PATTON
1ST ENGR BATTALION	MAJOR W. M. WINOSKI
1ST RECON BATTALION	LTCOL J. J. GRACE
1ST MT BATTALION	LTCOL M. S. SHIMANOFF
1ST SP BATTALION	LTCOL R. F. ARMSTRONG
1ST MED BATTALION	CAPT(MC) J. W. LEA
1ST TK BATTALION	MAJOR J. I. LOUDER
3RD AMTRAC BATTALION	LTCOL D. G. MEHARGUE
7TH ENGR BATTALION	LTCOL W. G. BATES
9TH ENGR BATTALION	LTCOL E. K. MAXWELL
11TH MT BATTALION	LTCOL W. R. KEPHART
	COMMANDING GENERAL
	BGEN M. J. PADALINO
	CHIEF OF STAFF
	COL J. L. TOBIN
	ACOS, G-1
	LTCOL J. E. REDELFS
	ACOS, G-2
	LTCOL R. L. SOLZE
	ACOS, G-3
	LTCOL W. W. STORM, III
	ACOS, G-4
	LTCOL M. H. IVINS
	ACOS, G-5
	MAJOR R. E. JOHNSON
	ACOS, COMPT
	LTCOL F. R. WARREN
	CEO
	MAJOR R. D. HAGAN
	<u>1ST FORCE SERVICE REGT</u>
	H&S BATTALION
	LTCOL L. R. WEBB
	SUPPLY BATTALION
	COL R. W. CALVERT
	MAINT BATTALION
	LTCOL E. C. MORRIS
	FLSG-B/1ST SERV BN
	COL D. E. MORIN
	5TH COMM BATTALION (REIN)
	LTCOL D. E. SHATZER
	7TH MT BATTALION
	LTCOL R. L. PRATHER
	1ST MP BATTALION
	LTCOL S. D. THOMADIS
	3RD MP BATTALION
	LTCOL C. FIMIAN

UNCLASSIFIED

Unclassified

SELECTED UNIT COMMANDERS AND STAFF OFFICERS

5 FEBRUARY 1970

1ST MARINE AIRCRAFT WING

COMMANDING GENERAL
AWC
CHIEF OF STAFF
ACOS, G-1
ACOS, G-2
ACOS, G-3
ACOS, G-4
ACOS, COMPT
CEO

MGEN W. G. THRASH
BGEN R. H. SPANJER
COL R. W. TELLER
COL G. S. STEWART
COL J. R. WEAVER
COL R. L. LAMAR
COL W. C. MCGRAW
COL E. J. ARTNAK
LTCOL T. KALUS

MWHG-1
COMMANDING OFFICER
H&HS-1
MWFS-1
MWCS-1

COL L. J. STIEN
MAJOR H. F. WITTER
LTCOL N. F. SCHNIPPEL, JR.
MAJOR A. B. RAY

MWSG-17
COMMANDING OFFICER
H&MS-17
WERS-17

COL R. A. SAVAGE
LTCOL D. SERRIN
MAJOR W. F. FARLEY

MACG-18
COMMANDING OFFICER
H&MS-18
MACS-4

COL S. G. DUNWIDDIE, JR.
LTCOL H. E. HOPPREYER, JR.
LTCOL R. W. MOLYNEUX, JR.

MASS-3
LTCOL J. H. DUBOTS

MAG-11
COMMANDING OFFICER
H&MS-11
MABS-11
VMCJ-1
VMA(AW)-225
VMA(AW)-242
VMO-2

COL N. E. HEFFERNAN
LTCOL R. F. HEBERT
LTCOL P. A. MANNING
LTCOL B. W. FARLEY
LTCOL J. J. METZKO
LTCOL S. P. LEWIS
LTCOL J. M. MORIARITY

MAG-12
COMMANDING OFFICER
H&MS-12
MABS-12
VMA-311

COL P. B. HENLEY
LTCOL J. J. WENT
LTCOL G. J. ERTLMEIR
MAJOR A. R. HICKLE

VMA-211
VMA-223
LTCOL L. GASPERINE, JR.
LTCOL J. W. IAZZO

MAG-13
COMMANDING OFFICER
H&MS-13
MABS-13
VMFA-115
VMFA-314

LTCOL T. E. MURPHREE
MAJOR F. J. HORAK, JR.
MAJOR R. D. REVIE
LTCOL D. P. BOWEN
LTCOL T. J. KELLY

VMFA-122
LTCOL R. E. HOWARD, JR.

MAG-16
COMMANDING OFFICER
H&MS-16
MABS-16

COL J. P. BRUCE
MAJOR M. T. HORNSEY
LTCOL P. C. SCAGLIONE

HMH-463
HML-167
HMM-364
HMM-263

LTCOL C. A. BLOCK
LTCOL J. E. WEBER
LTCOL C. R. DUNBAUGH
LTCOL W. R. LEDBETTER

HMM-161
HMM-262
HML-367

MAJOR B. H. MANN
LTCOL R. A. BANCROFT
LTCOL W. G. CRETNEY

3D MARINE AIRCRAFT WING

COMMANDING GENERAL
AWC
CHIEF OF STAFF
ACOS, G-1
ACOS, G-2
ACOS, G-3
ACOS, G-4

MGEN R. G. OWENS, JR.
BGEN J. A. FEELEY, JR.
COL H. N. MEHAFFEY
LTCOL L. A. GULLING
COL R. J. GRAHAM
COL D. WILKER

MWHG-3
COMMANDING OFFICER
H&MS-3
MWFS-3
MWCS-3

COL G. L. LILLICH
LTCOL J. B. LAVELLE
MAJOR J. S. LOOP
MAJOR D. B. NEWTON

MHTG-30
COMMANDING OFFICER
H&MS-30
HMHT-301
HMMT-302

COL A. F. GARROTTO
LTCOL R. W. CREIGHTON
LTCOL L. W. JARMAN
LTCOL K. D. VANEK

MAG-33
COMMANDING OFFICER
H&MS-33
MABS-33
VMCJ-3
VMA-214
VMFA-323 (CAIRE)
VMFAT-101
VMFA-531
VMFA-542
VMA-223

COL F. N. PIPPIN
LTCOL R. H. HUTCHINSON
MAJOR J. E. KEHRLE
LTCOL R. E. PERCIVAL
LTCOL W. R. SMITH
MAJ K. A. ZIMMERMAN II
LTCOL R. W. KRON
LTCOL J. L. THATCHER
LTCOL K. A. SMITH
LTCOL J. W. IAZZO

MWSG-37
COMMANDING OFFICER
H&MS-37
WERS-37
VMGR-352

COL F. E. WILSON
LTCOL D. L. RICE
LTCOL R. W. DUPHINEY
LTCOL H. D. STOTT

MACG-38
COMMANDING OFFICER
H&MS-38
SU#1, H&MS-38
MACG-1
MACS-3
MACS-7
1STLAAM BN
2NDLAAM BN

LTCOL T. I. GUNNING
MAJOR F. L. HARDING
MAJOR D. V. STOWELL
MAJ C. F. KELLENBARGER
LTCOL T. M. KAUFFMAN
LTCOL D. E. ROBERTS
MAJOR E. L. HOUSE, JR.
MAJOR H. J. BALDWIN, JR.

MAG-56
COMMANDING OFFICER
H&MS-56
MABS-56
HMH-363
HML-267
HMH-361
HMM-163
HMM-265

COL M. D. PORTER
LTCOL G. H. BUCKNER II
LTCOL F. L. YOHE
LTCOL R. P. BRAY
LTCOL J. M. BLANC
LTCOL K. W. ANDRUS
LTCOL F. A. MATHEWS
LTCOL R. G. COUNTRY

MCCRTG-10
COMMANDING OFFICER
H&MS-10
VMAT-102
VMT-103

COL G. PINK
MAJ I. L. DRIEFER
LTCOL B. A. SCHAFFER
LTCOL M. T. GARRISON

UNCLASSIFIED

UNCLASSIFIED

MARINE CORPS COMMAND CENTER

DISTRIBUTION OF MAJOR FMFPAC TACTICAL UNITS

5 FEBRUARY 1970

UNIT	CHU LAI	DANANG	NoICTZ/DMZ	OKINAWA	JAPAN	HAWAII	EASTPAC	OTHER	NOTE
1ST MARINES		1/1, 2/1, 3/1							
3D MARINES						1/3	2/3, 3/3		
4TH MARINES				1/4, 2/4, 3/4					
5TH MARINES		1/5, 2/5, 3/5							
7TH MARINES		1/7, 2/7, 3/7							
9TH MARINES				3/9				1/9, 2/9	1
26TH MARINES		1/26, 2/26, 3/26							
MAG-11		VMCJ-1 VNA(AW)-225 VMA(AW)-242 VMO-2							
MAG-12	VMA-211 VMA-311								
MAG-13	VMFA-115 VMFA-314 VMFA-122								
MAG-16		HML-167 HMH-463 HMM-263 HMM-364	EMM-161 HML-367 HMM-262						
MAG-36				HMH-462 VMO-6				HMM-164 HMM-165	1 1
MAG-15						VMFA-232 VMFA-334 VMA(AW)-533			
MAG-24						VMFA-212 VMFA-235			
MAG-33							VMA-223 VMCJ-3 VMA-214 VMFA-323* VMFA-531 VMFA-542 HML-267 HML-363 HMM-163 HMH-361 HMM-265		2 2
MAG-56									2

DISTRIBUTION OF MAJOR GROUND EQUIPMENT

EQUIPMENT	T/E AUTH	CHU LAI	DANANG	NoICTZ/DMZ	OKINAWA	HAWAII	EASTPAC	OTHER	NOTE
60mm MORTAR M19	254		144		60	12	24	12	1
81mm MORTAR M29	168		96		40	8	16	8	1
106mm RR M40A1C	168		96		40	8	16	8	1
107mm MORTAR M30	42		24		6	6		6	1
105mm HOW TD M101A1	136		72		30	6	12	6	1
155mm HOW SP M109	42		24		12		6		
175mm GUN (SP)	18		12	6					
81n HOW SP M110	14		12	2					
ONTOS M50A1	115		15		75		15	10	1
90mm TANK M48A3	126		73		36		17		
120mm TANK M103A2	17						17		
FLAME TANK M67A2	27		12		9		6		
LVTH6	18		6		12				
LVTP5	280		112		113		44	11	1
LVTE1	24		8		8		8		
HAWK LAUNCHERS	36						36		

NOTES: 1. UNITS/EQUIPMENT IN OTHER ASSIGNED TO SLP's.
2. ENROUTE CONUS.
3. ENROUTE OKINAWA.
* CATRE

Unclassified

UNCLASSIFIED

UNCLASSIFIED

DISTRIBUTION OF AIRCRAFT, FMFPAC

5 FEBRUARY 1970

	DANANG	CHU LAI	PBU BAI	OKINAWA	JAPAN	HAWAII	EASTPAC	OTHER
HQ SQDN, FMFPAC						6/T-1A 1/C-54R 1/C-47J		
MAG-11 H&MS-11	8/TA-4F 1/C-117D							
VMCJ-1	9/RF-4B							
VMA(AW)-242	8/EA-6A							
VMA(AW)-225	12/A-6A							
VMO-2	11/A-6A 23/AH-1G 19/OV-10A							
MAG-12 H&MS-12		1/C-117D						
VMA-211		19/A-4E						
VMA-311		19/A-4F						
MAG-13 H&MS-13		1/C-117D						
VMFA-115		14/F-4B						
VMFA-314		15/F-4B						
VMFA-122		11/F-4B						
MAG-15 H&MS-15					1/C-54Q 1/C-117D 3/TA-4F 1/C-54S 14/F-4J 12/F-4J 11/A-6A			
VMFA-232								
VMFA-334								
VMA(AW)-533								
MAG-16 H&MS-16	1/C-117D		1/C-117D 1/CH-46A					
HML-167	25/UH-1E		24/UH-1E					
HML-367								
HMM-263	21/CH-46D		21/CH-46D					
HMM-161			21/CH-46D					
HMM-262			21/CH-46D					
HMM-364	20/CH-46D							
HMH-463	21/CH-53A/D							
MCCRTG-10 H&MS-10								
VMAT-102							26/A-4C	
VMT-103							16/TA-4F	
MWSG-17 H&MS-17	3/US-2B 3/C-117D							
MHTG-30 H&MS-30							5/CH-46D	
HMHT-301							14/CH-53A	
HMMT-302							18/CH-46D	
MAG-33 H&MS-33							2/F-4B 6/TA-4F	
VMA-223							20/A-4E	**
VMCJ-3							8/RF-4B 1/F-4B 12/EF-10B 23/A-4C	**
VMA-214							12/F-4B	**
VMFA-323 (CADRE)							23/F-4B	**
VMFA-531							15/F-4B	**
VMFAT-101								
VMFA-542								
MAG-36 H&MS-36				1/C-117D 1/CH-46A				
VMGR-152				12/KC-130B				
HMM-165								18/CH-46A*
HMM-164								19/CH-46A*
HMH-462				20/CH-53A				
VMO-6				11/UH-1E 18/OV-10A				

NOTES: * ASSIGNED TO SLF's
** ENROUTE CONUS

CONFIDENTIAL

UNCLASSIFIED
Unclassified

~~SECRET~~

UNCLASSIFIED

MARINE CORPS COMMAND CENTER

MARINE CORPS PERSONNEL IN RVN

5 FEBRUARY 1970

	OFF	ENL	TOTAL
* III MAF.	3,717	50,490	54,207
DANANG	(3,159)	(43,644)	(46,803)
CHU LAI	(395)	(4,888)	(5,283)
PHU BAI	(126)	(1,211)	(1,337)
DONG HA	(37)	(747)	(784)
SU #1, 1ST ANGLICO (AT VARIOUS LOCATIONS SVN)	((22))	((192))	((214))
OTHER USMC PERSONNEL	160	152	312
MACV STAFF/MACV FIELD	(136)	(139)	(275)
NAVAVGRU/NAVY UNITS	(24)	(13)	(37)
USMC IN RVN CHARGED AGAINST PROGRAM VIII	3,877	50,642	54,519
U. S. NAVY, III MAF.	267	1,916	2,183

* AS REPORTED BY III MAF DAILY ADMIN SITREP # 0028 AS OF 2400, 27JAN70 AND ADJUSTED IN ACCORDANCE WITH MACV WEEKLY STRENGTH REPORT AND DAILY MACV REPORTS OF ARRIVALS/DEPARTURES AS OF 2400, 30JAN70.

UNCLASSIFIED

~~SECRET~~

UNCLASSIFIED WESTPAC UNIT LOCATIONS

5 FEBRUARY 1970

QUANG TRI (QUANG TRI CITY)	USMC	784
	USN	39 *
	USA	5,800
1ST BDE, 5TH INF DIV (MECH) 1/77 ARMOR (OPN GREEN RIVER) 1/61 INF (MECH) (OPN GREEN RIVER) 1/11 INF (OPN GREEN RIVER) 3/5 ARMD CAV SQDN (OPN GREEN RIVER)		

USMC RVN RECAP	USMC	USN *
OSD PROGRAM VIII CEILING	55,510	2,233
ACTUALS CHARGED AGAINST PROGRAM VIII AS OF 3FEB70	54,519	2,183
III MAF	54,207	2,183 #
SU#1, 1ST ANGLICO	((214))	((14))
MACV STP/MACV FLD	(275)	
NAVAIDVGRU/NAVY UNITS	(37)	

THUA THIEN HQ, XXIV CORPS (PHU BAI) HQ, 101st ABN DIV (AM)	USMC	1,337
	USN	44 *
	USA	26,050
1ST BDE, 101ST ABN DIV (AM) 1/327 INF (AM) (OPN RANDOLPH GLEN) 2/327 INF (AM) (OPN RANDOLPH GLEN) 2/502 INF (AM) (OPN RANDOLPH GLEN)		
2D BDE, 101ST ABN DIV (AM) 1/501 INF (AM) (OPN RANDOLPH GLEN) 2/501 INF (AM) (OPN RANDOLPH GLEN) 1/502 INF (AM) (OPN RANDOLPH GLEN)		
3D BDE, 101ST ABN DIV (AM) 1/506 INF (AM) (OPN RANDOLPH GLEN) 2/506 INF (AM) (OPN RANDOLPH GLEN) 3/187 INF (AM) (OPN RANDOLPH GLEN)		
1st MAW MAG-16 HML-367 (UH-1E) HMM-262 (CH-46D) HMM-161 (CH-46D)		

I CORPS RECAP	
US MARINE CORPS	(12 BNs) 54,207
US ARMY	(25 BNs) 73,849
US NAVY	17,410
US AIR FORCE	8,194
ROKMC	(4 BNs) 6,148
RVNAF	(36 BNs) 153,895
ARVN/ABN	(36 BNs) (74,634)
VNMC	
VNN	(2,100)
VNAF	(3,408)
VNRF	(37,403)
VNPF	(36,350)
I CORPS TOTAL	77 BNs 313,703

QUANG NAM HQS 1ST MAR DIV (DANANG)	HQS, III MAF	USMC	46,803 *
		USN	1,970 *
		USA	1,058
1ST MARINES 1/1 2/1 3/1			
5TH MARINES 1/5 2/5 3/5			
7TH MARINES 1/7 2/7 3/7			
26TH MARINES 1/26 2/26 3/26			
HO 1st MAW MAG-11 VMA(AW)-242 (A-6A) VMA(AW)-225 (A-6A) VMCJ-1 (RF-4/EA-6/EF-10) VMD-2 (AH-1G/OV-10A)			
MAG-16 (-) HML-167 (UH-1E) HMH-463 (CH-53A) HMM-364 (CH-46D) HMM-263 (CH-46D)			
2d ROKMC BDE 1/2 (OPN VICTORY DRAGON XIX-1) 2/2 (OPN VICTORY DRAGON XIX-21) 3/2 (OPN VICTORY DRAGON XIX) 5/2 (OPN VICTORY DRAGON XIX)			

SLF 7TH FLEET	USMC	USN
BRAVO: BLT 2/9	1,847	60
HMM-165		
AFLOAT OFF SUBIC		
ALFA: BLT 1/9	1,868	85
HMM-164		
AT OKINAWA		

QUANG TIN/QUANG NGAI HQ 23d INF DIV (AMERICAL) (CHU LAI)	USMC	5,283
	USN	130 *
	USA	24,106
196TH LT INF BDE 2/1 INF (OPN FREDERICK HILL) 4/31 INF (OPN FREDERICK HILL) 3/21 INF (OPN FREDERICK HILL) 1/46 INF		
198TH LT INF BDE 1/6 INF (OPN GENEVA PARK) 1/52 INF (OPN GENEVA PARK) 5/46 INF (OPN NANTUCKET BEACH)		
11TH INF BDE 1/20 INF (OPN IRON MOUNTAIN) 4/21 INF (OPN IRON MOUNTAIN) 3/1 INF (OPN IRON MOUNTAIN) 4/3 INF (OPN IRON MOUNTAIN) 1/1 ARMD CAV SQDN (OPN IRON MOUNTAIN)		
1st MAW MAG-12 (A-4E) VMA-211 (A-4E) VMA-311 (A-4E)		
MAG-13 VMFA-115 (F-4B) VMFA-314 (F-4B) VMFA-122 (F-4B)		

MOVEMENTS
B/1/4 & 2D Plat/B/3D Tk Bn at Fuji for training.
Det 12THMAR and "D" Co, 3D Recon at Namazu.

OKINAWA HQ, I MEF 3D MARDIV (-) (REIN)	USMC	USN
	19,200	934
OSD PROGRAM VIII CEILING		
ACTUALS CHARGED AGAINST PROGRAM VIII AS OF 29JAN70		
18,031 ● 424		
(14,061 ● (349))		
4TH MARINES 1/4 2/4 3/4	9TH MARINES 3/9	MAG-36 VMGR-152 (KC-130F) VMO-6 (OV-10A/UH-1E) HMH-462 (CH-53A)
3D FSR (2,906) ● (50)		
MCB CAMP BUTLER/NON FMP (921) ● (25)		
Non-Deployable Casuals (143) ●		
SVN-Originated Patients (0)		

JAPAN	USMC	USN
OSD PROGRAM VIII CEILING	3,600	45
ACTUALS CHARGED AGAINST PROGRAM VIII AS OF 29JAN70	3,753 ●	34
1st MAW (REAR)		
MAG-15 (2,553) ● (34)		
VMFA-232 (F-4J)		
VMFA-334 (F-4J)		
VMA(AW)-533 (A-6A)		
*Does NOT include 243 hospitalized SVN-Originated Patients.		
Unclassified (1,200) ●		

* Includes only U. S. Navy Personnel organic to FMF Units.
Includes SU#1 and 1st ANGLICO at various locations throughout SVN.
● Latest Change

UNCLASSIFIED SECRET

MARINE CORPS

FEB 10 1970

REFERENCE BRANCH

Unclassified

~~SECRET~~

SUMMARY OF MAJOR US AND FWMAF OPERATIONS

OPERATION (DATE COMMENCED)	UNITS INVOLVED	LOCATION	CASUALTIES AS OF: 052400H FEB70		
			FRIENDLY		ENEMY
			KIA	WIA	KIA.
GREEN RIVER (19JAN70)	1ST BDE, 5TH INF DIV (MECH); 4 USA BNS	EASTERN QUANG TRI PROVINCE	2	*60	28
RANDOLPH GLEN (7DEC69)	101ST ABN DIV (AM); 9 USA BNS	QUANG TRI & THUA THIEN PROVINCES	40	223	323
VICTORY DRAGON XIX (1JAN70)	2D ROKMC BDE; 2 BNS	HOI AN AREA	NONE	9	9
VICTORY DRAGON XIX-1 (25JAN70)	2D ROKMC BDE; 1 BN	HOI AN AREA	NONE	7	36
VICTORY DRAGON XIX-21 (31JAN70)	2D ROKMC BDE; 1 BN	HOI AN AREA	1	2	1
FREDERICK HILL (18MAR69)	196TH INF BDE; 3 USA BNS	QUANG TIN PROVINCE	367	2,292	4,403
GENEVA PARK (18JUL69)	198TH INF BDE; 2 USA BNS	QUANG TIN & QUANG NGAI PROVINCES	125	844	1,119
NANTUCKET BEACH (20JUL69)	198TH INF BDE; 1 USA BN	CENTERED 15 KM NE OF QUANG NGAI CITY	23	205	240
IRON MOUNTAIN (18MAR69)	11TH INF BDE; 5 USA BNS	QUANG NGAI PROVINCE	287	1,629	2,432

• - ADJUSTED
- FINAL CUMULATIVE CASUALTIES

~~SECRET~~

UNCLASSIFIED

Unclassified

MARINE CORPS COMMAND CENTER

UNCLASSIFIED

USMC/ENEMY CASUALTIES IN RVN

5 FEBRUARY 1970

USMC BATTLE CASUALTIES

KIA/DOW	WIA(EVAC)	WIA(RTD)	MIA/PW
12,424	48,727	35,729	83/21

USMC CASUALTY FIGURES ARE PROVIDED DAILY BY HQMC CASUALTY SECTION (CODE DNA) AND REFLECT ALL CASUALTIES REPORTED AS OF 4FEB70.

USMC NON-BATTLE CASUALTIES

DEAD	INJURED	MISSING
1,499	1,818	9

FIGURES INDICATED AS INJURED ARE ONLY THOSE IN SERIOUS/CRITICAL INJURY OR DISEASE CATEGORY AND DO NOT INCLUDE THOSE OF A MINOR NATURE

USMC INFLECTED ENEMY CASUALTIES

KIA	PW	WPNS
80,203	4,116	20,624

ENEMY CASUALTIES ARE COMPILED DAILY FROM THE III MAF HISSUM AND ARE RECONCILED MONTHLY WITH THE FMFPAC SUMMARY OF USMC OPERATIONS IN RVN

TYPICAL DISPOSITION OF 100 USMC WIA *

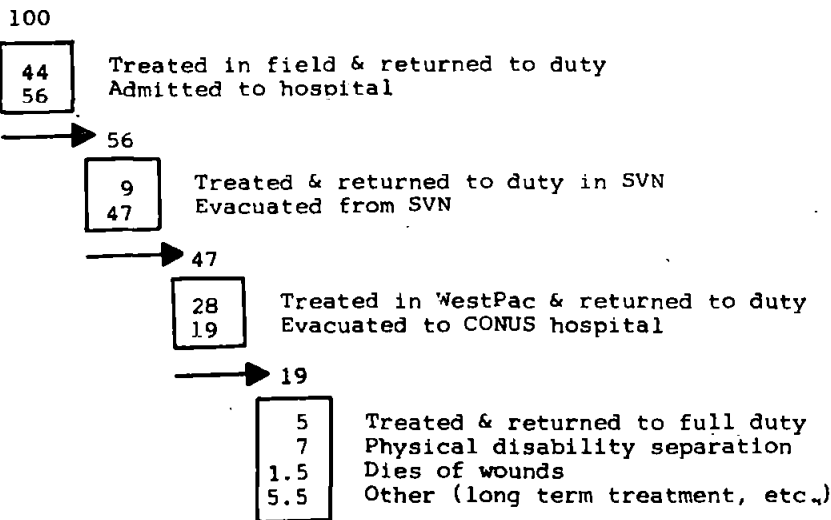

*54,081 CASUALTIES, JAN67-DEC68.

Unclassified

UNCLASSIFIED

MARINE CORPS COMMAND CENTER

MILITARY FORCES IN RVN *

5 FEBRUARY 1970

~~CONFIDENTIAL~~
UNCLASSIFIED

RVN ARMED FORCES (RVNAF)

ARMY (ARVN)	416,278
NAVY (VNN)	30,143
AIR FORCE (VNAF)	36,469
MARINE CORPS (VNMC)	11,528
REGIONAL FORCES (RF)	260,455
POPULAR FORCES (PF)	214,383
TOTAL RVNAF	969,256

UNITED STATES FORCES

ARMY	330,896
NAVY	29,784
AIR FORCE	57,384
MARINE CORPS	54,519
COAST GUARD	383
TOTAL U.S.	472,966

FREE WORLD MILITARY ASSISTANCE FORCES (FWMAF)

REPUBLIC OF KOREA	48,860
AUSTRALIA	7,694
PHILIPPINES	143
THAILAND	11,568
NEW ZEALAND	556
REPUBLIC OF CHINA	29
SPAIN	10
TOTAL FWMAF	68,860

TOTAL FORCES IN RVN 1,511,082

SOURCE: RVNAF MACV MONTHLY GIVEN FORCES STRENGTH DATA REPORT.

ALL OTHER, MACV WEEKLY STRENGTH REPORT AS OF 2400,
22JAN70 USMC STRENGTH: MACV WK STRENGTH REPORT AS
ADJUSTED BY MACV REPORT OF ARR/DEP AS OF 2400, 3FEB70.

UNCLASSIFIED
~~CONFIDENTIAL~~
25-1

~~CONFIDENTIAL~~

MARINE CORPS COMMAND CENTER

UNCLASSIFIED

SELECTED PERSONNEL AND AIRCRAFT DATA

PERSONNEL

6 FEBRUARY 1970

	STRENGTH	PERCENT USMC	PERCENT FMF	PERCENT FMFPAC
USMC TOTAL	300,982 *	100.00		
FLEET MARINE FORCES	153,729	51.08	100.00	
FMF ATLANTIC	45,696 \$	15.18	29.73	
FMF PACIFIC	108,033 #	35.90	70.27	
VIETNAM	54,516 ¢	18.11	35.46	50.47

SOURCE: * MONTHLY USMC PERSONNEL ALLOCATION REPORT OF 30NOV69.
 \$ MCCC UNIT REPORT OF 4FEB70.
 # MCCC UNIT REPORT OF 21JAN70.
 ¢ MACV WEEKLY STRENGTH REPORT AS OF 2400, 15JAN70 AS ADJUSTED BY MACV REPORT OF ARR/DEPART AS OF 2400, 4FEB70.

AIRCRAFT

5 FEBRUARY 1970

	FIXW	HELO	TOTAL	PERCENT USMC	PERCENT FMF	PERCENT FMFPAC
USMC TOTALS	1013	569	1582	100.00		
FLEET MARINE FORCES	763	543	1306	82.55	100.00	
FMF ATLANTIC	303	156	459	29.01	35.15	
FMF PACIFIC	460	387	847	53.54	64.85	
VIETNAM	156	178	334	21.11	25.57	39.43

SOURCE: MARINE CORPS COMMAND CENTER UNIT REPORT OF 31DEC69.

UNCLASSIFIED
 Unclassified

~~CONFIDENTIAL~~

UNCLASSIFIED SELECTED UNIT COMMANDERS AND STAFF OFFICERS

6 FEBRUARY 1970

1ST MARINE AIRCRAFT WING		3D MARINE AIRCRAFT WING	
COMMANDING GENERAL AWC CHIEF OF STAFF ACOS, G-1 ACOS, G-2 ACOS, G-3 ACOS, G-4 ACOS, COMPT CEO	MGEN W. G. THRASH BGEN R. H. SPANJER COL R. W. TELLER COL G. S. STEWART COL J. R. WEAVER COL R. D. LAMAR COL W. C. MCGRAW COL E. J. ARTNAK LTCOL T. KALUS	COMMANDING GENERAL AWC CHIEF OF STAFF ACOS, G-1 ACOS, G-2 ACOS, G-3 ACOS, G-4	MGEN R. G. OWENS, JR. BGEN J. A. FEELEY, JR. COL H. N. MEHAFFEY LTCOL L. A. GULLING COL R. J. GRAHAM COL D. WILKER
<u>MWHG-1</u> COMMANDING OFFICER H&HS-1 MWFS-1 MWCS-1	COL L. J. STIEN MAJOR H. F. WITTER LTCOL N. F. SCHNIPPEL, JR. MAJOR A. B. RAY	<u>MWHG-3</u> COMMANDING OFFICER H&HS-3 MWFS-3 MWCS-3	COL G. L. LILLICH LTCOL J. B. LAVELLE MAJOR J. S. LOOP MAJOR D. B. NEWTON
<u>MWSG-17</u> COMMANDING OFFICER H&HS-17 WERS-17	COL R. A. SAVAGE LTCOL D. SERRIN MAJOR W. F. FARLEY	<u>MHTG-30</u> COMMANDING OFFICER H&MS-30 HMHT-301 HMHT-302	COL A. F. GARROTTO LTCOL R. W. CREIGHTON LTCOL L. W. JARMAN LTCOL K. D. VANEK
<u>MACG-18</u> COMMANDING OFFICER H&HS-18 MACS-4 MASS-3	COL S. G. DUNWIDDIE, JR. LTCOL H. E. HOPFMEYER, JR. LTCOL R. W. MOLYNEUX, JR. LTCOL J. H. DUBOTS	<u>MAG-33</u> COMMANDING OFFICER H&MS-33 MABS-33 VMCJ-3 VMA-214 VMFA-323 (CAIRE) VMFAT-101 VMFA-531 VMFA-542 VMA-223	COL F. N. PIPPIN LTCOL R. H. HUTCHINSON MAJOR J. E. KEHRLE LTCOL R. E. PERCIVAL LTCOL W. R. SMITH MAJ K. A. ZIMMERMAN II LTCOL R. W. KRON LTCOL J. L. THATCHER LTCOL K. A. SMITH LTCOL J. W. IAZZO
<u>MAG-11</u> COMMANDING OFFICER H&MS-11 MABS-11 VMCJ-1 VMA(AW)-225 VMA(AW)-242 VMO-2	COL N. E. HEFFERNAN LTCOL R. F. HEBERT LTCOL P. A. MANNING LTCOL B. W. FARLEY LTCOL J. J. METZKO LTCOL S. P. LEWIS LTCOL J. M. MORIARITY	<u>MWSG-37</u> COMMANDING OFFICER H&MS-37 WERS-37 VMGR-352	COL F. E. WILSON LTCOL D. L. RICE LTCOL R. W. DUPHNEY LTCOL H. D. STOTT
<u>MAG-12</u> COMMANDING OFFICER H&MS-12 MABS-12 VMA-311 VMA-211 VMA-223	COL J. R. WEAVER LTCOL J. J. WENT LTCOL G. J. ERTLMEIR MAJOR A. R. HICKLE LTCOL L. GASPERINE, JR. LTCOL J. W. IAZZO	<u>MACG-38</u> COMMANDING OFFICER H&MS-38 SU#1, H&MS-38 MACS-1 MACS-3 MACS-7 1STLAAM BN 2NDLAAM BN	LTCOL T. I. GUNNING MAJOR F. L. HARDING MAJOR D. V. STOWELL MAJ C. P. KELLENBARGER LTCOL T. M. KAUFFMAN LTCOL D. E. ROBERTS MAJOR E. L. HOUSE, JR. MAJOR H. J. BALDWIN, JR.
<u>MAG-13</u> COMMANDING OFFICER H&MS-13 MABS-13 VMFA-115 VMFA-314 VMFA-122	LTCOL T. E. MURPHREE MAJOR F. J. HORAK, JR. MAJOR R. D. REVIE LTCOL D. P. BOWEN LTCOL T. J. KELLY LTCOL R. E. HOWARD, JR.	<u>MAG-56</u> COMMANDING OFFICER H&MS-56 MABS-56 HMH-363 HML-267 HMH-361 HMM-163 HMM-265	COL M. D. PORTER LTCOL G. H. BUCKNER II LTCOL F. L. YOHE LTCOL R. P. BRAY LTCOL J. M. BLANC LTCOL K. W. ANDRUS LTCOL F. A. MATHEWS LTCOL R. G. COUNTRY
<u>MAG-16</u> COMMANDING OFFICER H&MS-16 MABS-16 HMH-463 HML-167 HMM-364 HMM-263 HMM-161 HMM-262 HML-367	COL J. P. BRUCE MAJOR M. T. HORNSBY LTCOL P. C. SCAGLIONE LTCOL C. A. BLOCK LTCOL J. E. WEBER LTCOL C. R. DUNBAUGH LTCOL W. R. LEDBETTER MAJOR B. H. MANN LTCOL R. A. BANCROFT LTCOL W. G. CRETNEY	<u>MCCRTG-10</u> COMMANDING OFFICER H&MS-10 VMAT-102 VMT-103	COL G. FINK MAJ I. L. DRIEFER LTCOL B. A. SCHAFFER LTCOL M. T. GARRISON

UNCLASSIFIED

Unclassified

~~SECRET~~

UNCLASSIFIED

MARINE CORPS COMMAND CENTER

MARINE CORPS PERSONNEL IN RVN

6 FEBRUARY 1970

	OFF	ENL	TOTAL
* III MAF.	3,714	50,490	54,204
DANANG	(3,156)	(43,644)	(46,800)
CHU LAI	(395)	(4,888)	(5,283)
PHU BAI	(126)	(1,211)	(1,337)
DONG HA	(37)	(747)	(784)
SU #1, 1ST ANGLICO (AT VARIOUS LOCATIONS SVN)	((22))	((192))	((214))
OTHER USMC PERSONNEL	160	152	312
MACV STAFF/MACV FIELD	(136)	(139)	(275)
NAVAIDVGRU/NAVY UNITS	(24)	(13)	(37)
USMC IN RVN CHARGED AGAINST PROGRAM VIII	3,874	50,642	54,516
U. S. NAVY, III MAF.	267	1,916	2,183

* AS REPORTED BY III MAF DAILY ADMIN SITREP # 0028 AS OF 2400, 27JAN70 AND ADJUSTED IN ACCORDANCE WITH MACV WEEKLY STRENGTH REPORT AND DAILY MACV REPORTS OF ARRIVALS/DEPARTURES AS OF 2400, 4FEB70.

Unclassified

UNCLASSIFIED

~~SECRET~~

WESTPAC UNIT LOCATIONS

6 FEBRUARY 1970

QUANG TRI

(QUANG TRI)

1ST BDE, 5TH INF DIV (MECH)
 1/77 ARMOR (OPN GREEN RIVER)
 1/61 INF (MECH) (OPN GREEN RIVER)
 1/11 INF (OPN GREEN RIVER)
 3/5 ARMD CAV SQDN (OPN GREEN RIVER)

USMC 784
 USN 39 *
 USA 5,800

UNCLASSIFIED

THUA THIEN

HO, XXIV CORPS (PHU BAI)

HO, 101st ABN DIV (AM)

1ST BDE, 101ST ABN DIV (AM)
 1/327 INF (AM) (OPN RANDOLPH GLEN)
 2/327 INF (AM) (OPN RANDOLPH GLEN)
 2/502 INF (AM) (OPN RANDOLPH GLEN)

2D BDE, 101ST ABN DIV (AM)
 1/501 INF (AM) (OPN RANDOLPH GLEN)
 2/501 INF (AM) (OPN RANDOLPH GLEN)
 1/502 INF (AM) (OPN RANDOLPH GLEN)

3D BDE, 101ST ABN DIV (AM)
 1/506 INF (AM) (OPN RANDOLPH GLEN)
 2/506 INF (AM) (OPN RANDOLPH GLEN)
 3/187 INF (AM) (OPN RANDOLPH GLEN)

USMC 1,337
 USN .44 *
 USA 26,050

1st MAW

MAG-16
 HML-367 (UH-1E)
 HMM-262 (CH-46D)
 HMM-161 (CH-46D)

QUANG NAM

HQS 1ST MAR DIV (DANANG)

1ST MARINES
 1/1
 2/1
 3/1

5TH MARINES
 1/5
 2/5
 3/5

7TH MARINES
 1/7
 2/7
 3/7

26TH MARINES
 1/26
 2/26
 3/26

HQS, III MAF

USMC 46,803
 USN 1,970 *
 USA 1,058
 ROKMC 7,145

HO 1st MAW
 MAG-11

VMA(AW)-242 (A-6A)
 VMA(AW)-225 (A-6A)
 VMCJ-1 (RF-4/EA-6/EF-10)
 VMO-2 (AH-1G/OV-10A)

MAG-16 (-)
 HML-167 (UH-1E)
 HMM-463 (CH-53A)
 HMM-364 (CH-46D)
 HMM-263 (CH-46D)

2d ROKMC BDE

1/2 (OPN VICTORY DRAGON XIX-1)
 2/2 (OPN VICTORY DRAGON XIX-21)
 3/2 (OPN VICTORY DRAGON XIX)
 5/2 (OPN VICTORY DRAGON XIX)

FLC 1ST FSR/FLSG-B/1ST SERV BN

QUANG TIN/QUANG NGAI

HO 23d INF DIV (AMERICAL) (CHU LAI)

196TH LT INF BDE
 2/1 INF (OPN FREDERICK HILL)
 4/31 INF (OPN FREDERICK HILL)
 3/21 INF (OPN FREDERICK HILL)
 1/46 INF

198TH LT INF BDE
 1/6 INF (OPN GENEVA PARK)
 1/52 INF (OPN GENEVA PARK)
 5/46 INF (OPN NANTUCKET BEACH)

11TH INF BDE
 1/20 INF (OPN IRON MOUNTAIN)
 4/21 INF (OPN IRON MOUNTAIN)
 3/1 INF (OPN IRON MOUNTAIN)
 4/3 INF (OPN IRON MOUNTAIN)
 1/1 ARMD CAV SQDN (OPN IRON MOUNTAIN)

1st MAW

MAG-12 (A-4E)
 VMA-211 (A-4E)
 VMA-311 (A-4E)

MAG-13
 VMFA-115 (F-4B)
 VMFA-314 (F-4B)
 VMFA-122 (F-4B)

USMC 5,283
 USN 130 *
 USA 24,106

OKINAWA

HO, I MEF
 3D MARDIV (-) (REIN)

4TH MARINES
 1/4
 2/4
 3/4

9TH MARINES
 3/9

MAG-36 (14,061) (349)
 VMGR-152 (KC-130F)
 VMO-6 (OV-10A/UH-1E)
 HMM-462 (CH-53A)

3D FSR (2,906) (50)
 MCB CAMP BUTLER/NON FMF (921) (25)
 Non-Deployable Casuals (143)
 SVN-Originated Patients (0)

USMC 19,200
 USN 934

OSD PROGRAM VIII CEILING
 ACTUALS CHARGED AGAINST PROGRAM VIII AS OF 29JAN70. 18,031 424

USMC RVN RECAP

	USMC	USN *
OSD PROGRAM VIII CEILING	55,510	2,233
ACTUALS CHARGED AGAINST PROGRAM VIII AS OF 4FEB70.	54,516	2,183
III MAF	54,204	2,183
SU#1, 1ST ANGLICO	((214))	((14))
MACV STF/MACV FLD	(275)	
NAVADVGRU/NAVY UNITS	(37)	

I CORPS RECAP

US MARINE CORPS	(12 BNs)	54,204
US ARMY	(25 BNs)	73,849
US NAVY		17,097
US AIR FORCE		8,194
ROKMC	(4 BNs)	6,148
RVNAF	(36 BNs)	153,895
ARVN/ABN	(36 BNs)	(74,634)
VNMC		
VNN		(2,100)
VNAF		(3,408)
VNRF		(37,403)
VNPF		(36,350)
I CORPS TOTAL	77 BNs	313,387

SLF 7TH FLEET

	USMC	USN
BRAVO: BLT 2/9	1,847	60
HMM-165		
AFLOAT OFF SUBIC		
ALFA: BLT 1/9	1,868	85
HMM-164		
AT OKINAWA		

MOVEMENTS

B/1/4 & 2D Plat/B/3D Tk Bn at Fuji for training.

Det 12THMAR and "D" Co, 3D Recon at Namazu.

JAPAN

	USMC	USN
OSD PROGRAM VIII CEILING	3,600	45
ACTUALS CHARGED AGAINST PROGRAM VIII AS OF 29JAN70.	3,753	34
1ST MAW (REAR)	(2,553)	(34)
MAG-15		
VMFA-232 (F-4J)		
VMFA-334 (F-4J)		
VMA(AW)-533 (A-6A)		

*Does NOT include 243 hospitalized SVN-Originated Patients.

Non-FMF (1,200)

* Includes only U. S. Navy Personnel organic to FMF Units.
 # Includes SU#1 and 1st ANGLICO at various locations throughout SVN.
 • Latest Change

Unclassified

UNCLASSIFIED

MARINE CORPS

FFB 10 1970

REFERENCE BRANCH

Unclassified

~~SECRET~~
UNCLASSIFIED SUMMARY OF MAJOR RVNAF OPERATIONS

OPERATION (DATE COMMENCED)	UNITS INVOLVED	LOCATION	CASUALTIES AS OF: 062400H FEB70		
			FRIENDLY		ENEMY
			KIA	WIA	KIA
LAM SON 350 (1JAN70)	2ND REGT: 1/2, 2/2, 3/2, 4/2 & 5/2	5 KM E OF GIO LINH	15	64	153
LAM SON 353 (1JAN70)	7TH CAV: 3/7 CAV	5 KM SE OF GIO LINH	6		14
LAM SON 354 (6JAN70)	54TH REGT: 3/54	6 KM S. OF QUANG TRI CITY	1	NONE	NONE
LAM SON 352 (1JAN70)	54TH REGT: 1/54, 2/54 & 4/54	2 KM NW OF PHU BAI	1	1	20
LAM SON 349 (1JAN70)	1ST REGT: 1/1, 2/1, 3/1 & 4/1	21 KM NW OF A LUOI	7	33	101
LAM SON 351 (1JAN70)	3RD REGT: 1/3, 2/3, 3/3 & 4/3	25 KM SW OF HUE	4	17	29
HUNG QUANG 1/22 (12JAN70)	51ST REGT: 1/51	16 KM NW OF HOI AN	NONE	5	NONE
QUYET THANG 54 (2JAN70)	5TH REGT: 1/5, 2/5, 4/5, 2/6 & 4/6	12 KM W OF TAM KY	19	50	99
QUYET THANG 63 (2JAN70)	6TH REGT: 3/6	18 KM NW OF QUANG NGA1 CITY	15	82	71
QUYET THANG 45 (4JAN70)	4TH REGT: 1/4, 2/4, 3/4 & 4/4	11 KM SW OF DUC PHO	16	43	217

ALL UNITS ARE ARVN UNLESS DESIGNATED
 * - ADJUSTED
 # - FINAL CUMULATIVE CASUALTIES

~~SECRET~~

UNCLASSIFIED

Unclassified

~~UNCLASSIFIED~~

MARINE CORPS COMMAND CENTER

6 FEBRUARY 1970

CHRONOLOGY OF III MAF BUILDUP IN RVN

		JUNE 1969					
99	BLT 3/26	11JUN69	1,354		DANANG		
	AFLOAT	CHU LAI	DMZ AREA	PHU BAI	DANANG	TOTALS 30JUN69	
	(2,541) (142)	(6,106) (135)	(25,637) (1,204)	(2,462) (60)	(44,066) (1,735)	USMC 80,812 *	USN 3,276
						TOTAL 84,088	
						* INCLUDES SLF's	
		JULY 1969					
	AFLOAT	CHU LAI	DMZ AREA	PHU BAI	DANANG	TOTALS 31JUL69	
	(928) (28)	(6,149) (138)	(21,663) (1,047)	(2,368) (55)	(46,173) (1,822)	USMC 77,281 *	USN 3,090
						TOTAL 80,371	
						* INCLUDES SLF's	
		AUGUST 1969					
100 101	HMM-361 HMM-164	4AUG69 13AUG69	268 237		PHU BAI DANANG		
	AFLOAT	CHU LAI	DMZ AREA	PHU BAI	DANANG	TOTALS 31AUG69	
	(1,868) (195)	(5,618) (122)	(18,894) (967)	(2,385) (51)	(43,138) (1,658)	USMC 71,903 *	USN 2,993
						TOTAL 74,896	
						* INCLUDES SLF's	
		SEPTEMBER 1969					
102 103	VMFA-122 BLT 1/26	5SEP69 7SEP69	332 1780		CHU LAI DANANG		
	AFLOAT	CHU LAI	DMZ AREA	PHU BAI	DANANG	TOTALS 30SEP69	
	(2,181) (192)	(5,591) (122)	(18,337) (981)	(2,234) (59)	(42,630) (1,705)	USMC 70,973 *	USN 3,059
						TOTAL 74,032	
						* INCLUDES SLF's	
		OCTOBER 1969					
104	BLT 2/26	20OCT69	1792		DANANG		
		CHU LAI	DMZ AREA	PHU BAI	DANANG	TOTALS 31OCT69	
		(5,087) (123)	(9,761) (658)	(2,446) (64)	(46,885) (1,963)	USMC 64,179	USN 2,808
						TOTAL 66,987	
		NOVEMBER 1969					
		CHU LAI	DMZ AREA	PHU BAI	DANANG	TOTALS 30NOV69	
		(5,000) (138)	(1,153) (283)	(1,857) (67)	(47,291) (1,959)	USMC 55,301	USN 2,447
						TOTAL 57,748	
		DECEMBER 1969					
		CHU LAI	DMZ AREA	PHU BAI	DANANG	TOTALS 31DEC69	
		(5,040) (139)	(799) (39)	(1,163) (48)	(47,619) (1,937)	USMC 54,621	USN 2,163
						TOTAL 56,784	
		JANUARY 1970					
		CHU LAI	DMZ AREA	PHU BAI	DANANG	TOTALS 31JAN70	
		(5,283) (130)	(784) (39)	(1,337) (44)	(47,494) (1,970)	USMC 54,848	USN 2,188
						TOTAL 57,031	

~~UNCLASSIFIED~~
UNCLASSIFIED

MARINE CORPS COMMAND CENTER

UNCLASSIFIED

USMC/ENEMY CASUALTIES IN RVN

6 FEBRUARY 1970

USMC BATTLE CASUALTIES

KIA/DOW	WIA(EVAC)	WIA(RTD)	MIA/PW
12,425	48,758	35,741	83/21

USMC CASUALTY FIGURES ARE PROVIDED DAILY BY HQMC CASUALTY SECTION (CODE DNA) AND REFLECT ALL CASUALTIES REPORTED AS OF 5 FEB 70.

USMC NON-BATTLE CASUALTIES

DEAD	INJURED	MISSING
1,499	1,818	9

FIGURES INDICATED AS INJURED ARE ONLY THOSE IN SERIOUS/CRITICAL INJURY OR DISEASE CATEGORY AND DO NOT INCLUDE THOSE OF A MINOR NATURE

USMC INFLECTED ENEMY CASUALTIES

KIA	PW	WPNS
80,238	4,116	20,628

ENEMY CASUALTIES ARE COMPILED DAILY FROM THE III MAF HISSUM AND ARE RECONCILED MONTHLY WITH THE FMFPAC SUMMARY OF USMC OPERATIONS IN RVN

TYPICAL DISPOSITION OF 100 USMC WIA *

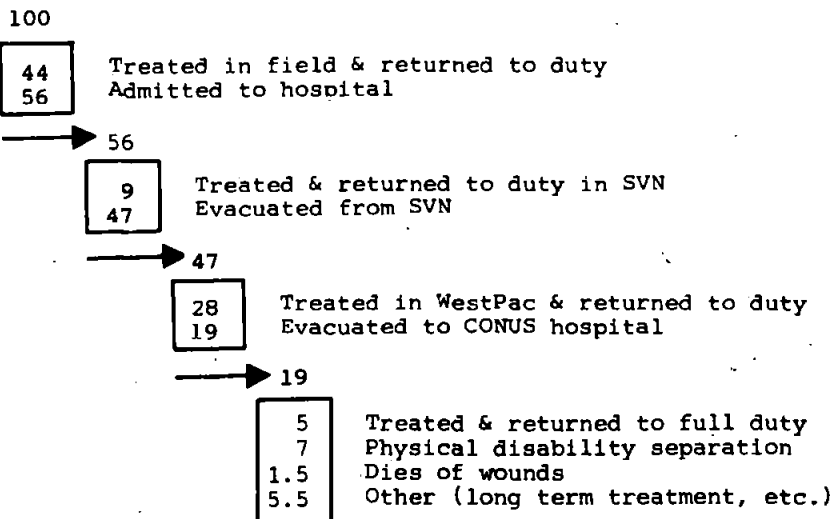

*54,081 CASUALTIES, JAN67-DEC68.

Unclassified

UNCLASSIFIED

~~UNCLASSIFIED~~

MARINE CORPS COMMAND CENTER

MILITARY FORCES IN RVN *

6 FEBRUARY 1970

RVN ARMED FORCES (RVNAF)

ARMY (ARVN)	416,278
NAVY (VNN)	30,143
AIR FORCE (VNAF)	36,469
MARINE CORPS (VNMC)	11,528
REGIONAL FORCES (RF)	260,455
POPULAR FORCES (PF)	214,383
TOTAL RVNAF	969,256

UNITED STATES FORCES

ARMY	330,896
NAVY	29,784
AIR FORCE	57,384
MARINE CORPS	54,516
COAST GUARD	383
TOTAL U.S.	472,963

FREE WORLD MILITARY ASSISTANCE FORCES (FWMAF)

REPUBLIC OF KOREA	48,860
AUSTRALIA	7,694
PHILIPPINES	143
THAILAND	11,568
NEW ZEALAND	556
REPUBLIC OF CHINA	29
SPAIN	10
TOTAL FWMAF	68,860

TOTAL FORCES IN RVN 1,511,079

SOURCE: RVNAF MACV MONTHLY GIVEN FORCES STRENGTH DATA REPORT

ALL OTHER, MACV WEEKLY STRENGTH REPORT AS OF 2400,
22JAN70 USMC STRENGTH: MACV WK STRENGTH REPORT AS
ADJUSTED BY MACV REPORT OF ARR/DEP AS OF 2400, 4FEB70.

Unclassified
~~UNCLASSIFIED~~

UNCLASSIFIED

MARINE CORPS COMMAND CENTER
DISTRIBUTION OF PERSONNEL*
FLEET MARINE FORCE, ATLANTIC

6 FEBRUARY 1970

Table with columns: UNIT, NOTE, ASSIGNED STRENGTH (USMC, USN), STR RPT DATE, NORFOLK (USMC, USN), CAM LEJ/NEW RIV (USMC, USN), CHER PT (USMC, USN), BEAUFORT (USMC, USN), ROOS RDS (USMC, USN), GTMO (USMC, USN), LANFOR CARIB (USMC, USN), LANFOR 6THFLT (USMC, USN), OTHER (USMC, USN). Rows include HEADQUARTERS FMPLANT (H&S BN, HQS SQDN) and HQS LANT TOTAL.

FORCE TROOPS

Table with columns: UNIT, NOTE, ASSIGNED STRENGTH (USMC, USN), STR RPT DATE, NORFOLK (USMC, USN), CAM LEJ/NEW RIV (USMC, USN), CHER PT (USMC, USN), BEAUFORT (USMC, USN), ROOS RDS (USMC, USN), GTMO (USMC, USN), LANFOR CARIB (USMC, USN), LANFOR 6THFLT (USMC, USN), OTHER (USMC, USN). Rows include HQS CO, 2D FSR, H&S BN, SUP BN, MAINT BN, 2U FAG, HQS BTRY, 2D 155MM GUN BTRY, 2D 8IN HOW BTRY, 2D TANK BN, 2D AMTRAC BN, 2D RADIO BN, 2D FORCE RECON CO, 2D ANGLICO, 2D BRIDGE CO, 2D TOPO CO, 2D HOSPITAL CO, 2D SEP SURGICAL CO, 4TH DENTAL CO, 8TH COMM BN, 8TH MT BN, 8TH ENGR BN, and FORTRPS TOTAL.

2D MARINE DIVISION

Table with columns: UNIT, NOTE, ASSIGNED STRENGTH (USMC, USN), STR RPT DATE, NORFOLK (USMC, USN), CAM LEJ/NEW RIV (USMC, USN), CHER PT (USMC, USN), BEAUFORT (USMC, USN), ROOS RDS (USMC, USN), GTMO (USMC, USN), LANFOR CARIB (USMC, USN), LANFOR 6THFLT (USMC, USN), OTHER (USMC, USN). Rows include HEADQUARTERS BN, 2D MARINES (HQS CO, 1ST BN, 2D BN, 3D BN), 6TH MARINES (HQS CO, 1ST BN, 2D BN, 3D BN), 8TH MARINES (HQS CO, 1ST BN, 2D BN, 3D BN), 10TH MARINES (HQS BTRY, 1ST BN, 2D BN, 3D BN, 4TH BN), 2D SERVICE BN, 2D AT BN, 2D MT BN, 2D RECON BN, 2D ENGR BN, 2D SP BN, 2D MEDICAL BN, 2D DENTAL CO, and ZDMARDIV TOTAL.

2D MARINE AIRCRAFT WING

Table with columns: UNIT, NOTE, ASSIGNED STRENGTH (USMC, USN), STR RPT DATE, NORFOLK (USMC, USN), CAM LEJ/NEW RIV (USMC, USN), CHER PT (USMC, USN), BEAUFORT (USMC, USN), ROOS RDS (USMC, USN), GTMO (USMC, USN), LANFOR CARIB (USMC, USN), LANFOR 6THFLT (USMC, USN), OTHER (USMC, USN). Rows include MWHG-2 (H&HS-2, MWFS-2, MWCS-2, 12TH FORCE DENTAL CO), MWSG-27 (H&MS-27, WERS-27, VMGR-252).

* UNLESS OTHERWISE NOTED, STRENGTHS AND LOCATIONS INDICATED ARE THOSE REPORTED BY UNIT PERSONNEL STATUS REPORTS AND DO NOT REFLECT DAY-TO-DAY ADJUSTMENTS BETWEEN REPORTING PERIODS.

UNCLASSIFIED

CONFIDENTIAL
~~UNCLASSIFIED~~

DISTRIBUTION OF PERSONNEL

FLEET MARINE FORCE, ATLANTIC

6 FEBRUARY 1970

UNIT	NOTE	ASSIGNED STRENGTH		STRENGTH RPT DATE	NORFOLK		CAM LEJ/NEW RIV		CHERRY PT		BEAUFORT		GTMO		LANFOR CARIB		LANFOR6TH FLT		OTHER	
		USMC	USN		USMC	USN	USMC	USN	USMC	USN	USMC	USN	USMC	USN	USMC	USN	USMC	USN	USMC	USN
MWCG-28																				
H&MS-28		329	5						329	5										
MASS-1		206							206											
MACS-5		305							305											
MACS-6		268							268											
MACS-9		310							310											
3D LAAM BN		631	7						631	7										
MAG-14																				
H&MS-14		575							575											
MABS-14		320							320											
MATCU-61		48							48											
VMCJ-2		370	2						370	2										
VMA(AW)-224		222	2						222	2										
VMA(AW)-121		201	1						201	1										
VMA(AW)-332		216	2						216	2										
VMFA-513		216	2						216	2										
MCCRTG-20																				
H&MS-20		570	2						570	2										
VMFAT-201		436	1						436	1										
VMAT(AW)-202		283	2						283	2										
VMT-203		188	2						188	2										
MAG-26																				
H&MS-26		582						582												
MABS-26		479	38					479	38											
MATCU-64		87						87												
VMO-1		277						277												
HMM-162		203	1					203	1											
HMM-261		234	3					21	2							213	1			
HMM-264		204						204												
HMM-365		195	1					195	1											
HMH-461		164	1					164	1											
HMH-362		109						109												
MHTG-40																				
H&MS-40		183						183												
HMHT-401		131						131												
HMMT-402		141						141												
MAG-31																				
H&MS-31		582									582									
MABS-31		337	16								337	16								
MATCU-69		62									62									
VMFA-331		163	1								163	1								
VMFA-333		215	1								215	1								
VMFA-451		215	1								215	1								
MAG-32																				
H&MS-32		559									559									
MABS-32		338	17								338	17								
MATCU-63		57									57									
VMFA-251		233	1								233	1								
VMFA-312		236	1								236	1								
VMA(AW)-324		165	1								165	1								
USMC		14,040						4,971	5,694	3,162						213				
USN		180						112	28	39						1				
2D MAW TOTAL		14,220						5,083	5,722	3,201						214				

RECAPITULATION OF EMFLANT PERSONNEL DISTRIBUTION

	ASSIGNED STRENGTH	NORFOLK	CAM LEJ/NEW RIV	CHERRY PT	BEAUFORT	GTMO	LANFOR CARIB	LANFOR6TH FLT	OTHER	
HQS LANT TOTAL	USMC	815	815							
	USN	18	18							
FORTRPS TOTAL	USMC	9,523		8,838		107	104	111	363	
	USN	154		153					1	
ZDMARDIV TOTAL	USMC	21,318		17,051		1,081	1,735	1,451		
	USN	673		514		26	80	53		
2D MAW TOTAL	USMC	14,040		4,971	5,694	3,162		213		
	USN	180		112	28	39		1		
GRAND TOTAL	USMC	45,696	815	30,860	5,694	3,162	1,188	2,052	1,562	363
	USN	1,025	18	779	28	39	26	81	53	1

- NOTES: 1. AT YUMA FOR TRAINING. TOTAL PERSONNEL NOT RECEIVED.
2. A TOTAL OF 83 PERSONNEL IN "OTHER" ARE ASSIGNED TO IT, ITT, SSC AND ARE NOT ON THE ROLLS OF HQS CO.
3. PERSONNEL LISTED IN "OTHER" ARE AT CAMP GARCIA.

** UNLESS OTHERWISE NOTED, STRENGTH REPORT DATE IS 4FEB70.

UNCLASSIFIED

~~CONFIDENTIAL~~

UNCLASSIFIED

MARINE CORPS COMMAND CENTER

SELECTED PERSONNEL AND AIRCRAFT DATA

PERSONNEL

7 FEBRUARY 1970

	STRENGTH	PERCENT USMC	PERCENT FMF	PERCENT FMFPAC
USMC TOTAL	300,982 *	100.00		
FLEET MARINE FORCES	153,729	51.08	100.00	
FMF ATLANTIC	45,696 \$	15.18	29.73	
FMF PACIFIC	108,033 #	35.90	70.27	
VIETNAM	54,548 ¢	18.11	35.46	50.47

SOURCE: * MONTHLY USMC PERSONNEL ALLOCATION REPORT OF 30NOV69.

\$ MCCC UNIT REPORT OF 4FEB70.

MCCC UNIT REPORT OF 21JAN70.

¢ MACV WEEKLY STRENGTH REPORT AS OF 2400, 15JAN70 AS ADJUSTED BY MACV REPORT OF ARR/DEPART AS OF 2400, 5FEB70.

AIRCRAFT

5 FEBRUARY 1970

	FIXW	HELO	TOTAL	PERCENT USMC	PERCENT FMF	PERCENT FMFPAC
USMC TOTALS	1013	569	1582	100.00		
FLEET MARINE FORCES	763	543	1306	82.55	100.00	
FMF ATLANTIC	303	156	459	29.01	35.15	
FMF PACIFIC	460	387	847	53.54	64.85	
VIETNAM	156	178	334	21.11	25.57	39.43

SOURCE: MARINE CORPS COMMAND CENTER UNIT REPORT OF 31DEC69.

UNCLASSIFIED
Unclassified

UNCLASSIFIED
FLEET MARINE FORCE DEPLOYMENTS

7 FEBRUARY 1970

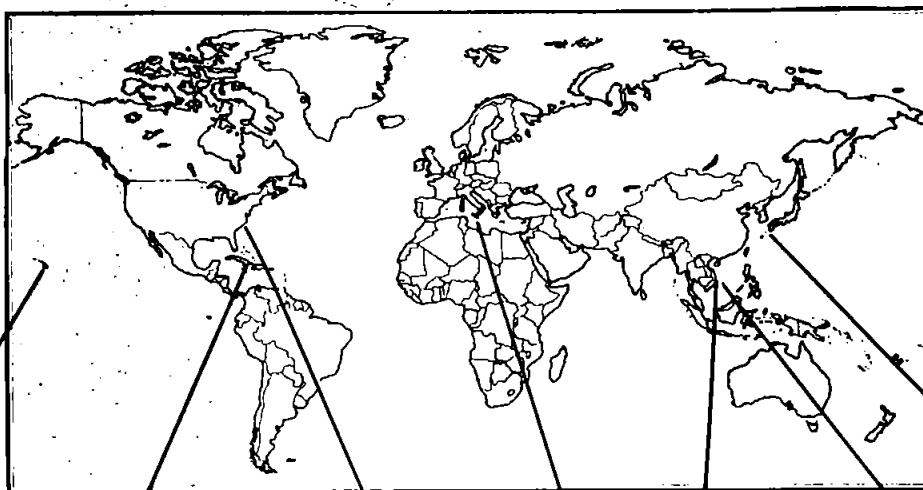

1ST MAR BRIG
HAWAII

GTMO AUGMENT
2D BN, 8TH MAR
BTRY B/1/10
PLT 2D TK BN
PLT 2D ANGLICO
DET FSR

LANFORCARIB 1-70
BLT 3/2 & HMM-261
AT CRISTOBAL

LANFOR6THFLT 3-69
ENROUTE GREECE

III MAF
RVN

SLF, 7TH FLEET
SLF BRAVO
AFLOAT 150 NM
WEST OF SUBIC

I MEF
OKINAWA
& JAPAN

B/1/4 & 2D PLAT/B/3D
TK BN AT FUJI FOR
TRAINING.

SLF ALFA
AT OKINAWA

DISTRIBUTION OF MAJOR FMF UNITS

	INF BNS	VMFA	VMA	VMA(AW)	VMCI	HMM	HMH	HML	VMO	VMGR
WESTPAC	18	5	2	3	1	6	2	2	2	1
RVN	(12)	(3)	(2)	(2)	(1)	(4)	(1)	(2)	(1)	
OKINAWA/JAPAN	(4)	(2)		(1)			(1)		(1)	(1)
ASSIGNED TO SLF	(2)					(2)				
MIDPAC	1	2								
HAWAII	(1)	(2)								
AFLOAT										
EASTPAC	2	3	2		1	2	2	1		1
WEST COAST	(2)	(3)	(2)		(1)	(2)	(2)	(1)		(1)
AFLOAT										
ATLANTIC	8	5	2	3	1	4	2		1	1
EAST COAST	(6)	(5)	(2)	(3)	(1)	(3)	(2)		(1)	(1)
CARIBBEAN	(2)					(1)				
EUROPE	1									
MEDITERRANEAN	(1)									
GRAND TOTAL	30	15	6	6	3	12	6	3	3	3

* CA'RE

UNCLASSIFIED

MARINE CORPS COMMAND CENTER

5TH MARINE EXPEDITIONARY BRIGADE

READINESS SUMMARY

7 FEBRUARY 1970

UNCLASSIFIED

UNIT	*REPORT DATE	STRENGTH		COMBAT READINESS							
				CURRENT					EXPECTED		
				RATING	REASON	P	S	E	T	RATING	DATE
5TH MEB				C2	T	1	1	1	2	C1	30APR70
H&SCO (-) (REIN)		1943	83	C1		1	1	1	1		
3D MARINES (-)		2612	122	C2	P	2	1	1	2	C1	1FEB70
HQS CO (-)		331	9	C1		1	1	1	1		
2nd BN		1137	58	C2	T	1	1	1	2	C1	1FEB70
3rd BN		1144	55	C2	P	2	1	1	2	C1	1FEB70
1ST BN, 12TH MARINES (-)		1310	21	C1	X	1	1	1	1		
"N" BTRY, 4TH BN, 12THMAR		133	1	C4	X	4	1	2	4		
"A" CO, 3D AT BN (-)		105	4	C2	T	1	1	1	2	C1	1MAR70
"A" CO, 3D RECON BN (-)		93	5	C2	T	1	1	1	2	C1	1FEB70
"C" CO, 3D MED BN (-)		81	55	C2	P	2	1	1	2	C1	28FEB70
"B" CO, 3D ENGR BN (-)		169	1	C1		1	1	1	1		
"B" CO, 3D MI BN (-)		81	2	C2	T	1	1	1	2	C1	31JAN70
"B" CO, 3D SP BN (-)		135	16	C1		1	1	1	1		
"E" CO, 3D TANK BN (REIN)		210	6	C2	T	1	1	1	2	C1	1MAR70
DET, 3D SERVICE BN		945	18	C1		1	1	1	1		
REINFORCING UNITS											
COMM SPT CO, 9TH COMM BN		281		C2	T	1	1	1	2	C1	1FEB70
"B" CO, 11TH ENGR (REIN)		265	2	C1		1	1	1	1		
"B" CO, 9TH MT BN (REIN)		156	1	C1		1	1	1	1		
"A" CO, 1ST AMTRAC BN (-)		228	4	C1		1	1	1	1		
13TH ITT		15		C1	P	1	1	1	1	C2	31JULY70
9TH SSCT		6		C1		1	1	1	1		
13TH CIT		28		C1		1	1	1	1		
1ST SEARCHLIGHT BTRY				C4	N	4	4	4	4	C4	1FEB70
9TH SEP BULK FUEL CO		383		C3	T	1	1	1	3	C2	15JAN70
DET, 3D DENTAL CO		16		C1		1	1	1	1		
3D BRIDGE CO (-)		149	1	C2	T	1	1	1	2	C1	28FEB70
3D HOSPITAL CO		30	41	C2	P	2	1	1	2	C1	30JUN70
1ST AMRD AMPHIB CO (-)		94		C4	S	1	4	4	4	C3	1JUN70
1ST CIVIL AFFAIRS GROUP		82	4	C4	T	3	1	1	4	C3	1FEB70
21ST ITT		8		C4	P	4	1	1	4	C3	31JAN70

READINESS CATEGORIES

- C-1 Fully Combat Ready
- C-2 Substantially Combat Ready
- C-3 Marginally Combat Ready
- C-4 Not Combat Ready

READINESS ABBREVIATIONS

- P Personnel Readiness
- S Supplies/Equipment on Hand
- E Equipment Readiness
- T Training Readiness
- X Commanders Subjective Judgement-Elaborated by remarks
- N Resource allocation by cognizant service does not permit a higher C-rating

NOTE: Readiness Category Information extracted from SMU REPORT DATES 2FEB70.
Strength Category Information extracted from MCCC Report dated 16JAN70.

Unclassified

UNCLASSIFIED

~~SECRET~~

UNCLASSIFIED

MARINE CORPS COMMAND CENTER

MARINE CORPS PERSONNEL IN RVN

7 FEBRUARY 1970

	OFF	ENL	TOTAL
* III MAF.	3,517	50,719	54,204
DANANG	(3,019)	(44,238)	(47,257)
CHU LAI	(389)	(4,885)	(5,274)
PHU BAI	(74)	(886)	(960)
DONG HA	(35)	(710)	(745)
SU #1, 1ST ANGLICO (AT VARIOUS LOCATIONS SVN)	((22))	((192))	((214))
OTHER USMC PERSONNEL	160	152	312
MACV STAFF/MACV FIELD	(136)	(139)	(275)
NAVAADVGRU/NAVY UNITS	(24)	(13)	(37)
USMC IN RVN CHARGED AGAINST PROGRAM VIII	3,677	50,871	54,548
U. S. NAVY, III MAF.	259	1,839	2,098

* AS REPORTED BY III MAF DAILY ADMIN SITREP # 0036 AS OF 2400, 4FEB70. AND ADJUSTED IN ACCORDANCE WITH MACV WEEKLY STRENGTH REPORT AND DAILY MACV REPORTS OF ARRIVALS/DEPARTURES AS OF 0100, 5FEB70.

UNCLASSIFIED

UNCLASSIFIED
~~SECRET~~

SECRET

WESTPAC UNIT LOCATIONS

7 FEBRUARY 1970

QUANG TRI

(QUANG TRI)

1ST BDE, 5TH INF DIV (MECH)	USMC	745
1 77 ARMOR (OPN GREEN RIVER)	USN	38
1 61 INF (MECH) (OPN GREEN RIVER)	USA	5,808
1 11 INF (OPN GREEN RIVER)		
3 5 ARMED CAV SQDN (OPN GREEN RIVER)		

USMC RVN RECAP

	USMC	USN
OSD PROGRAM VIII CEILING	55,510	2,233
ACTUALS CHARGED AGAINST PROGRAM VIII AS OF 5 FEB 70	54,548	2,098
III MAF	54,236	2,098
SU#1, 1ST ANGLICO	((214))	((114))
MACV STF/MACV FLD	(275)	
NAVAIRGRU/NAVY UNITS	(37)	

THUA THIEN

HQ, XXIV CORPS (PHU BAI)
HQ, 101st ABN DIV (AM)

1ST BDE, 101ST ABN DIV (AM)	USMC	960
1 327 INF (AM) (OPN RANDOLPH GLEN)	USN	47
2 327 INF (AM) (OPN RANDOLPH GLEN)	USA	26,177
2 502 INF (AM) (OPN RANDOLPH GLEN)		
2D BDE, 101ST ABN DIV (AM)		
1 501 INF (AM) (OPN RANDOLPH GLEN)		
2 501 INF (AM) (OPN RANDOLPH GLEN)		
1 502 INF (AM) (OPN RANDOLPH GLEN)		
3D BDE, 101ST ABN DIV (AM)		
1 506 INF (AM) (OPN RANDOLPH GLEN)		
2 506 INF (AM) (OPN RANDOLPH GLEN)		
3 187 INF (AM) (OPN RANDOLPH GLEN)		

I CORPS RECAP

	USMC	USN
US MARINE CORPS	(12 BNS) 54,236	
US ARMY	(25 BNS) 73,849	
US NAVY		17,097
US AIR FORCE		8,194
ROKMC	(4 BNS) 5,148	
RVNAF	(36 BRs) 153,895	
ARVN/ABN	(36 BNS) (74,634)	
VNMC		
VNN		(2,100)
VNAF		(3,408)
VNRF		(37,403)
VNPF		(36,350)
I CORPS TOTAL	77 BNS	313,419

QUANG NAM

HQS, III MAF

HQS 1ST MAR DIV (DANANG)	USMC	47,257
1ST MARINES	USN	1,889
1 1	USA	1,090
2 1		
3 1		
5TH MARINES		
1 5		
2 5		
3 5		
7TH MARINES		
1 7		
2 7		
3 7		
26TH MARINES		
1 26		
2 26		
3 26		

HQ 1st MAW

MAG-16	(UH-1E)
HNL-367	(UH-1E)
HMM-262	(CH-46D)
HMM-161	(CH-46D)

VMA(AW)-242 (A-6A)
VMA(AW)-225 (A-6A)
VNCJ-1 (RF-4/LA-6/EF-10)
VMO-2 (AH-1G/OV-10A)

MAG-16 (-)
HNL-167 (UH-1E)
HMH-463 (CH-53A)
HMM-364 (CH-46D)
HMM-263 (CH-46D)

2d ROKMC BDE

1/2 (OPN VICTORY DRAGON XIX-1)
2/2 (OPN VICTORY DRAGON XIX-1)
3/2 (OPN VICTORY DRAGON XIX)
5/2 (OPN VICTORY DRAGON XIX)

SLF 7TH FLEET

	USMC	USN
BRavo: BLT 2/9	1,847	60
HMM-165		
AFLOAT 150NM WEST OF SUBIC		
ALFA: BLT 1/9	1,868	85
HMM-164		
AT OKINAWA		

FLC 1ST FER/FLSG-B/1ST SERV BN

QUANG TIN/QUANG NGAI

HQ 23d INF DIV (AMERICAL) (CHU LAI)

196TH LT INF BDE	USMC	5,274
2/1 INF (OPN FREDERICK HILL)	USN	124
4/31 INF (OPN FREDERICK HILL)	USA	24,331
3/21 INF (OPN FREDERICK HILL)		
1/46 INF		
198TH LT INF BDE		
1/6 INF (OPN GENEVA PARK)		
1/52 INF (OPN GENEVA PARK)		
5/46 INF (OPN NANTUCKET BEACH)		
11TH INF BDE		
1/20 INF (OPN IRON MOUNTAIN)		
4/21 INF (OPN IRON MOUNTAIN)		
3/1 INF (OPN IRON MOUNTAIN)		
4/3 INF (OPN IRON MOUNTAIN)		
1/1 ARMED CAV SQDN (OPN IRON MOUNTAIN)		

HQ 1st MAW

MAG-12	(A-4E)
VMA-211	(A-4E)
VMA-311	(A-4E)

MAG-13

VMFA-115	(F-4B)
VMFA-314	(F-4B)
VMFA-122	(F-4B)

MOVEMENTS

B/1/4 & 2D Plat/B/3D Tk Bn at Fuji for training.

Det 12THMAR and 'D' Co, 3D Recon at Namazu.

OKINAWA

HQ, I MAF

3D MAR DIV (-) (REIN)	USMC	19,200	934
OSD PROGRAM VIII CEILING			
ACTUALS CHARGED AGAINST PROGRAM VIII AS OF 29 JAN 70		18,031	424
4TH MARINES			
1/4			
2/4			
3/4			
9TH MARINES			
3/9			
MAG-36	(14,061)	(349)	
VMGR-152	(KC-130F)		
VMO-6	(OV-10A/UH-1E)		
HMH-462	(CH-53A)		
3D FSR	(2,906)	(50)	
MCB CAMP BUTLER/NON FMF	(921)	(25)	
Non-Deployable Casuals	(143)		
SVN-Originated Patients	(0)		

JAPAN

	USMC	USN
OSD PROGRAM VIII CEILING	3,600	45
ACTUALS CHARGED AGAINST PROGRAM VIII AS OF 29 JAN 70	3,753	34
1ST MAW (REAR)		
MAG-15	(2,553)	(34)
VMFA-232	(F-4J)	
VMFA-334	(F-4J)	
VMA(AW)-533	(A-6A)	
*Does NOT include 243 hospitalized SVN-Originated Patients.		
Non FMF	(1,200)	

* Includes only U. S. Navy Personnel organic to FMF Units.
Includes SU#1 and 1st ANGLICO at various locations throughout SVN.
● Latest Change

Unclassified
UNCLASSIFIED

MARINE CORPS

FEB 10 1970

REFERENCE BRANCH

Unclassified

UNCLASSIFIED

USMC/ENEMY CASUALTIES IN RVN

7 FEBRUARY 1970

USMC BATTLE CASUALTIES

KIA/DOW	WIA(EVAC)	WIA(RTD)	MIA/PW
12,432	48,773	35,752	83/21

USMC CASUALTY FIGURES ARE PROVIDED DAILY BY HQMC CASUALTY SECTION (CODE DNA) AND REFLECT ALL CASUALTIES REPORTED AS OF 6 FEB 70.

USMC NON-BATTLE CASUALTIES

DEAD	INJURED	MISSING
1,499	1,818	9

FIGURES INDICATED AS INJURED ARE ONLY THOSE IN SERIOUS/CRITICAL INJURY OR DISEASE CATEGORY AND DO NOT INCLUDE THOSE OF A MINOR NATURE

USMC INFLICTED ENEMY CASUALTIES

KIA	PW	WPNS
80,260	4,117	20,629

ENEMY CASUALTIES ARE COMPILED DAILY FROM THE III MAF HISSUM AND ARE RECONCILED MONTHLY WITH THE FMFPAC SUMMARY OF USMC OPERATIONS IN RVN

TYPICAL DISPOSITION OF 100 USMC WIA *

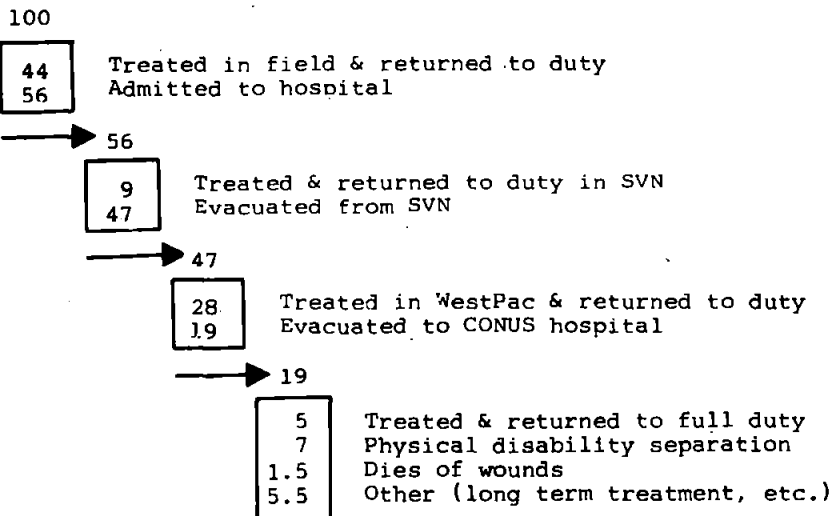

*54,081 CASUALTIES, JAN67-DEC68.

UNCLASSIFIED

Unclassified

SPECIAL LANDING FORCE, 7TH FLEET

UNCLASSIFIED

SLF BRAVO

7 FEBRUARY 1970

TASK GROUP 79.4 CTG: COL G. G. CHAMBERS JR.	STRENGTH				ARMS & EQUIPMENT	LOCATION		
	USMC		USN					
UNITS EMBARKED	OFF	ENL	OFF	ENL				
SLF HQS DET					8 M29 81MM MORTARS 3 M40 106MM RR 6 M30 107MM MORTARS 4 M101A1 105MM HOW 4 M48 90MM TANKS 5 LVTP-5	AFLOAT 150 NM WEST OFF SUBIC		
BLT 2/9 (LTCOL J. R. VANDENELZEN) 2D BN, 9TH MARINES W/2/12 E/2/12 PLAT, CO "B", 1ST AMTRAC PLAT, CO "C", 3D ENGR BN PLAT, CO "C", 3D SP BN PLAT, CO "C", 3D NT BN PLAT, CO "C", 3D RECON BN PLAT, CO "A", 3D TK BN CLEAR PLAT, CO "B", 3D MED SQD, MP CO, 3D MARDIV DET, HQBN, 3D MARDIV DET, COMM PLT, HQCO, 9TH MAR DET, COMM SPT CO, 7TH COMM DET, 3D DENTAL CO LSU	52	1500	1	56			SHIPPING USS NEW ORLEANS (LPH-11) USS THOMASTON (LSD-28) USS VANCOUVER (LPD-2) USS WHITFIELD CTY (LST-1169)	
HMM-165 (LTCOL P. H. MITCHELL)	69	226	1	2		SUPPLIES CLASS I CLASS II CLASS III CLASS IV CLASS V		
TOTALS	121	1726	2	58				AIRCRAFT 18/CH-46A

SLF ALFA

28 JANUARY 1970

TASK GROUP 79.5 CTG: COL C. W. BOYD, JR.	STRENGTH				ARMS & EQUIPMENT	LOCATION		
	USMC		USN					
UNITS EMBARKED	OFF	ENL	OFF	ENL				
SLF HQS DET					12 M10 60MM MORTARS 8 M29 81MM MORTARS 3 M40 106 MM RR 6 M30 107 MM MORTARS 6 M101A1 105 MM HOW 5 M48 90MM TANKS	AT OKINAWA		
BLT 1/9 (LTCOL D. J. MC ADAMS) 1ST BN, 9TH MARINES MORT BTRY, 2/12 BTRY "D" (REIN), 2/12 PLAT, CO "B", 1ST AMTRAC BN PLAT, CO "C", 3D ENGR BN PLAT, CO "C", 3D SP BN PLAT, CO "A", 3D MT BN PLAT, CO "C", 3D RECON BN PLAT, CO "C", 3D TK BN CLEAR PLT, CO "B", 3D MED BN SQD, MP CO, 3D MARDIV DET, HQ BN DET, COMM PLT HQ CO, 9TH MAR DET, 3D DENTAL CO LSU DET BMU NEG	54	1596	6	76			SHIPPING	
HMM-164 (LTCOL R. D. FOWNER)	41	177	1	2		SUPPLIES CLASS I 30 DAYS CLASS II 30 DAYS CLASS III 30 DAYS CLASS IV 30 DAYS CLASS V 30 DAYS		
TOTALS	95	1773	7	78				AIRCRAFT 19/CH-46A's

Unclassified

UNCLASSIFIED

~~CONFIDENTIAL~~

SUMMARY OF MARINE CO.,PS AMPHIBIOUS OPERATIONS IN SOUTH VIETNAM

7 FEBRUARY 1970

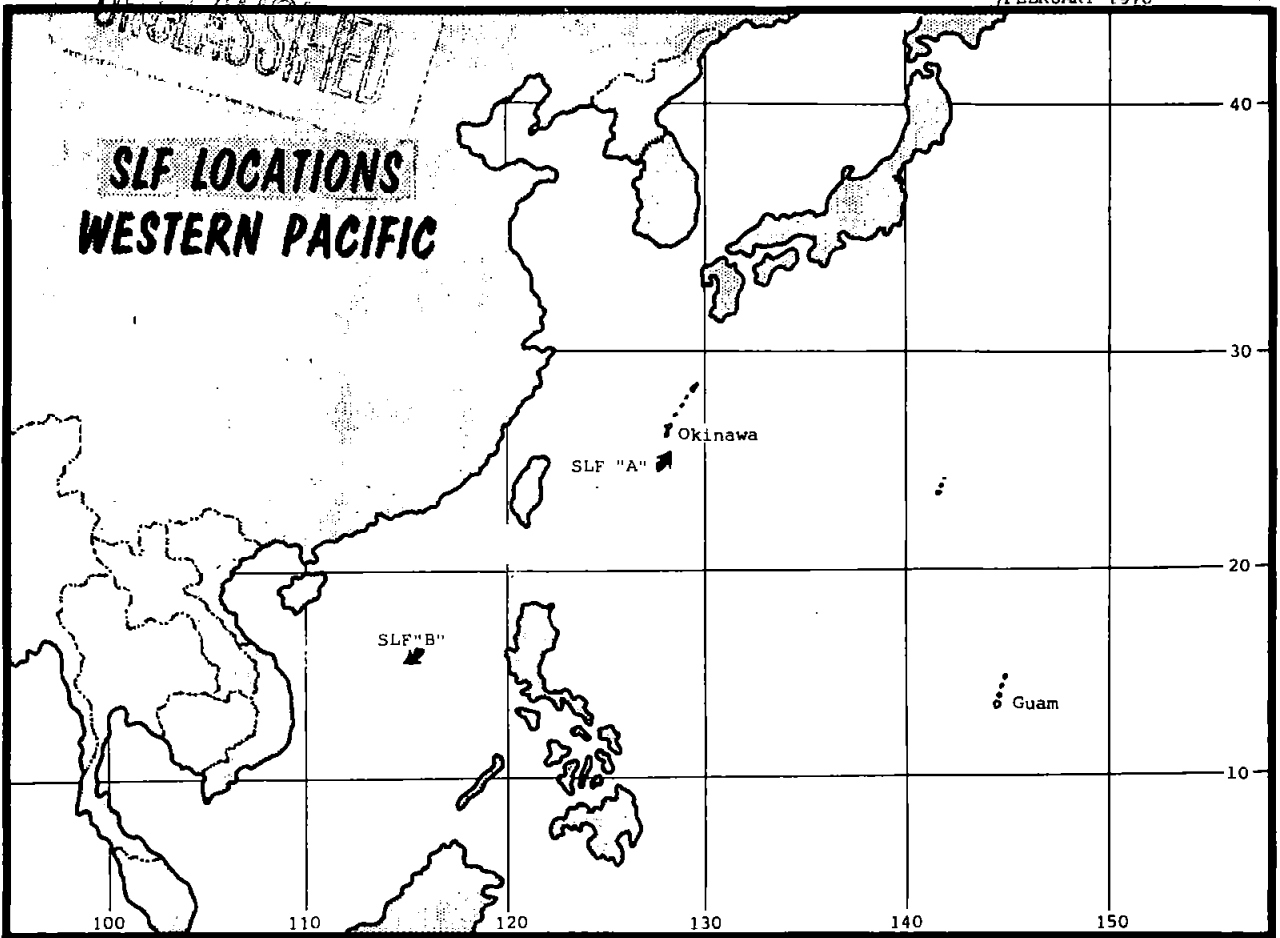

TOTAL AMPHIBIOUS OPERATIONS 71 (INCLUDING SLF OPERATIONS AS INDICATED ON THIS AND SUBSEQUENT PAGES)

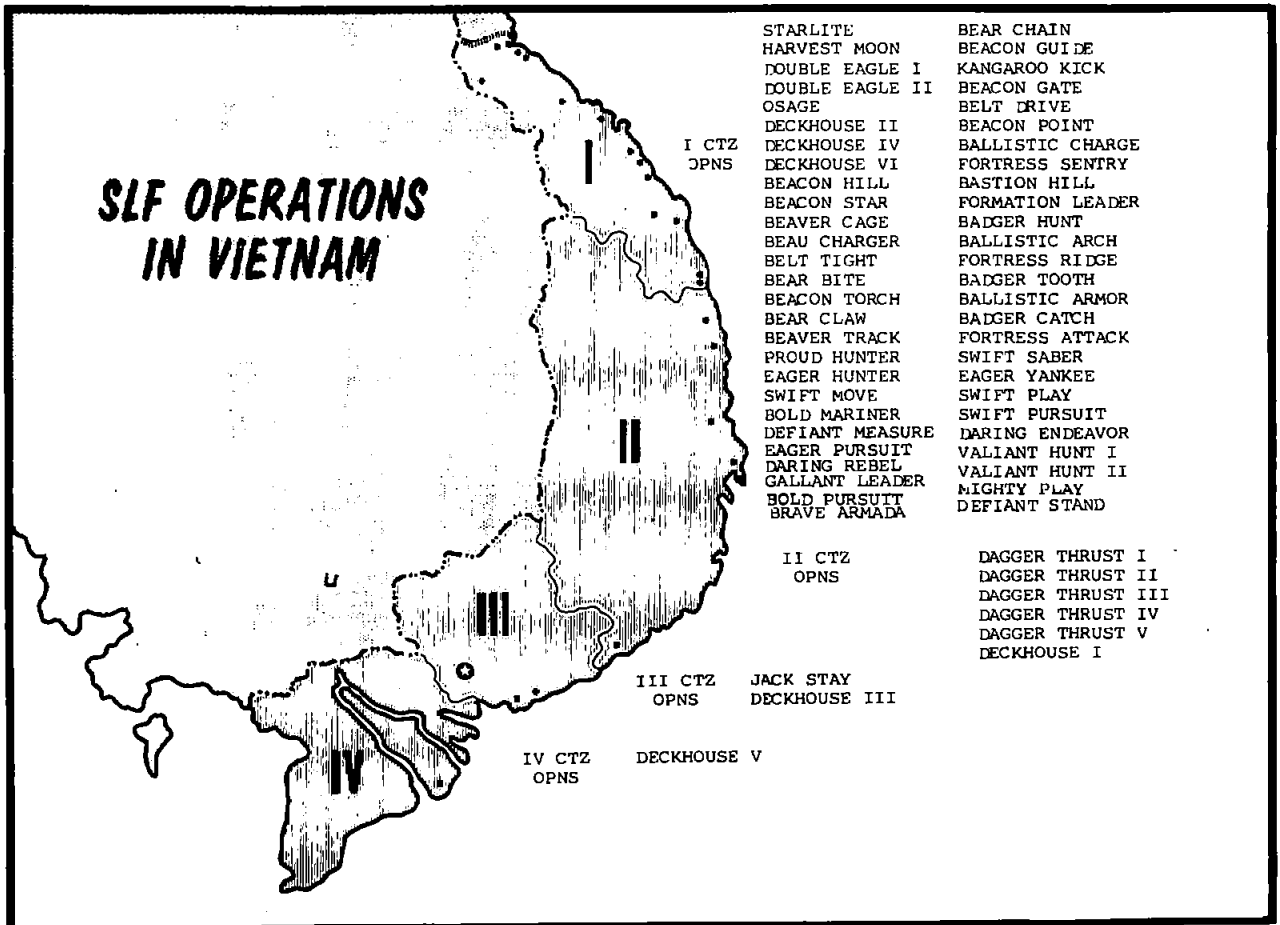

SUMMARY OF SLF OPERATIONS ON FOLLOWING PAGE

~~CONFIDENTIAL~~

UNCLASSIFIED

~~CONFIDENTIAL~~

MARINE CORPS COMMAND CENTER

UNCLASSIFIED

MILITARY FORCES IN RVN *

7 FEBRUARY 1970

RVN ARMED FORCES (RVNAF)

ARMY (ARVN)	416,278
NAVY (VNN)	30,143
AIR FORCE (VNAF)	36,469
MARINE CORPS (VNMC)	11,528
REGIONAL FORCES (RF)	260,455
POPULAR FORCES (PF)	214,383

TOTAL RVNAF 969,256

UNITED STATES FORCES

ARMY	330,896
NAVY	29,784
AIR FORCE	57,384
MARINE CORPS	54,548
COAST GUARD	383

TOTAL U.S. 472,995

FREE WORLD MILITARY ASSISTANCE FORCES (FWMAF)

REPUBLIC OF KOREA	48,860
AUSTRALIA	7,694
PHILIPPINES	143
THAILAND	11,568
NEW ZEALAND	556
REPUBLIC OF CHINA	29
SPAIN	10

TOTAL FWMAF 68,860

TOTAL FORCES IN RVN 1,511,111

SOURCE: RVNAF MACV MONTHLY GVEN FORCES STRENGTH DATA REPORT.

ALL OTHER, MACV WEEKLY STRENGTH REPORT AS OF 2400,
22JAN70 USMC STRENGTH: MACV WK STRENGTH REPORT AS
ADJUSTED BY MACV REPORT OF ARR/DEP AS OF 2400, 5FEB70.

UNCLASSIFIED

Unclassified

7 FEBRUARY 1970

PRINCIPAL MARINE OFFICERS COMUSMACV STAFF, HQ USMACV

DEPUTY J-3	BGEN SAMUEL JASKILKA
EXECUTIVE ASST TO AC/S, J-3	COL HENSLEY WILLIAMS
DIRECTOR, COMBINED INTELLIGENCE CENTER, VIETNAM, J-2	COL CHARLES W. STEPHENSON, III
CHIEF, OPERATIONAL PLANS/ REQUIREMENTS DIVISION	COL JOSEPH DIFRANK, JR.
CHIEF, SPECIAL OPERATIONS DIVISION	COL PAUL FUSS
CHIEF, RESEARCH AND ANALYSIS DIVISION	COL VICTOR A. KLEBER, JR.
CHIEF, PLANS/REQUIREMENTS DIVISION, J-44	COL ARTHUR C. BEVERLY
CHIEF, U.S./SEATO DIVISION, J-52	COL EDWARD V. FINN
SENIOR MARINE ADVISOR, NAG	COL WILLIAM M. VANZUYEN
DEPUTY, INFORMATION OFFICER	COL WILLIAM R. BLACKWELL
DEPUTY JOINT SECRETARY	COL EDWARD Y. HOLT, JR.
ASSISTANT TO ASSISTANT C/S, CORDS	COL LOUIS H. STEMAN
G-3, ADVISOR, IV CORPS	COL EDWARD G. MEYER
CHIEF, COMMAND CENTER	COL ROBERT V. REESE
CHIEF, PLANS AND PROGRAMS BRANCH, I CTZ, CORDS	COL WILMER W. HIXSON

UNCLASSIFIED

UNCLASSIFIED

UNCLASSIFIED

3 FEBRUARY 1970

COMMANDERS AND PRINCIPAL-STAFF OFFICERS, HQ USMACV

COMUSMACV	GEN Creighton W. Abrams, USA
Dep COMUSMACV	GEN William B. Rosson, USA
Dep COMUSMACV for Air	GEN George S. Brown, USAF
Dep COMUSMACV for Civ Opns and Revolutionary Development Support (CORDS) 1/■	
CofS, MACV	Amb William E. Colby
Dep CofS, MACV	MG Elias C. Townsend, USA
ACofS, J1	BG James M. Vandehey, USAF
ACofS, J2	BG Albert H. Smith, Jr., USA (P)
ACofS, J3	BG William E. Potts, USA
Dep ACofS, J3	MG Edward Bautz, Jr., USA
Dep ACofS, J3	BG William R. Kraft, Jr., USA
ACofS, J4	BG Samuel Jaskilka, USMC
ACofS, J5	MG Raymond C. Conroy, USA
ACofS, J6	MG Richard F. Shaefer, USAF
ACofS, Military Assistance MACV	BG Geoffrey Cheadle, USAF
Dir of Training/Spec Asst to COMUSMACV	BG Frank L. Gunn, USA
ACofS for CORDS	BG Wallace L. Clement, USA
Dep ACofS for CORDS	Mr. George D. Jacobson
Comptroller	BG David S. Henderson
Dir of Construction	COL Richard G. Fazakerley, USA
Chief of SOG	BG Elmer P. Yates, USA
Chief of Information	COL Stephen E. Cavanaugh, USA
Surgeon, MACV	COL Joseph F. H. Cutrona, USA
	BG Richard R. Taylor, USA

SELECTED COMMANDERS AND STAFF OFFICERS IN USARV

Dep CG, USARV	LTG Frank T. Mildren
CofS, USARV	MG George L. Mabry, Jr.
Dep CofS, Plans & Opns	BG Frank Meszar
Dep CofS, Pers & Admin	BG Verne L. Bowers (P)
Asst CofS, C-E, USARV	MG Thomas M. Rienzi
Aviation Officer, USARV	BG George W. Putnam, Jr.
Engineer Officer, USARV	BG John A. B. Dillard
Provost Marshal, USARV	COL Wallace K. Wittwer
Surgeon, USARV	BG David E. Thomas
CG, Engr Const Agency, USARV	BG Robert M. Tarbox
CG, Capital Military Assistance Command	Vacant

HQ III MAF

Commanding General	LTG Herman Nickerson, Jr., USMC
Deputy Commanding General	MG George S. Bowman, Jr., USMC
CofS	BG George E. Doolley, USMC
DCSOPS	COL John R. Thurman III, (P) USA
ACofS, G3	BG Leo J. Dulacki, USMC

ARMY MAJOR UNITS COMMANDERS IN THAILAND

Commander, USMACTHAI, and Chief, JSMAG, Thailand	MG Louis T. Seith, USAF
Deputy Commander, USMACTHAI	MG Jack J. Wagstaff, USA
US Army Spt Thailand	BG David E. Ott
9th Log Command	COL Raymond A. Troxell
40th MP Bn	LTC Thomas M. Jones
538th Engr Const Bn	LTC Bernard C. Hughes
809th Engr Const Bn	LTC Joseph S. Wood, Jr.
7th Maint Bn	LTC Roland E. Berg
29th Sig Gp (STRATCOM)	COL Donald L. Jenkins
379th Sig Bn (Spt)	LTC Harry J. Walther
519th Trans Bn (Trk)	LTC Robert L. Vidrick
133d Med Gp	COL Arthur A. Terrill
46th SF Co	LTC Stephen R. Johnson
442d Sig Bn (Long Line)	LTC Ed E. Jones
93d PSYOP Co	MAJ Dile C. Skillicorn
302d Sig Bn	LTC Norman F. Hubbard
325th Sig Bn	MAJ William E. Moore

1/ CORDS has been changed from Civil Operations and Revolutionary Development Support to Civil Operations and Rural Development Support to more accurately describe functions and align CORDS with the newly named GVN Ministry of Rural Development. The organization and functions of CORDS remain the same.

DATE FOR REMOVAL OF PROTECTIVE MARKINGS CANNOT BE PREDETERMINED.

UNCLASSIFIED

26-2

Unclassified

(pp 2-9 dtd 3 Feb 70)

3 FEBRUARY 1970

**GENERAL OFFICERS AND COMMANDERS OF MAJOR UNITS AND MANEUVER BATTALIONS
AND
DIVISION CHIEFS OF STAFF**

MO USARV Commanding General Dep Commanding General Chief of Staff Dep CofS, Plans & Opns Dep CofS, Para & Admin		GEN Creighton W. Abrams LTG Frank T. Mildren MG George L. Mabry, Jr. BG Frank Messar BG Verne L. Bowers (P)		MO I FIELD FORCE RVN Commanding General Dep Commanding General Chief of Staff Artillery Officer		LTG Charles A. Corcoran MG Joseph R. Russ BG Richard H. Johnson COL Charles M. Hall (P)	
MO XXIV CORPS Commanding General Dep Commanding General Chief of Staff Artillery Officer		LTG Melvin Zeis, USA MG Edwin B. Wheeler, USMC BG William E. Shedd, III COL Robert C. Hixon (P)		MO II FIELD FORCE RVN Commanding General Dep Commanding General Chief of Staff Artillery Officer		LTG Julian J. Ewell Vacant BG Leo D. Kinnard BG Francis J. Roberts	
1st Inf Div Asst Div Commander Asst Div Commander Chief of Staff Div Arty Commander Spt Comd Commander		MG Albert E. Milloy BG Herbert E. Wolff COL John Q. Menion (P) COL Albert G. Hume COL John P. Kean COL Frank D. Conant, Jr.		101st Abn Div (Abnl) Asst Div Commander Asst Div Commander Chief of Staff Div Arty Commander Spt Comd Commander		MG John M. Wright, Jr. BG James C. Smith BG John J. Hennessey (P) COL Hugh A. MacDonald LTC Richard S. Fye (P) COL Robert H. Siegrist	
1st Brigade 1st Bn, 2d Inf 1st Bn, 26th Inf 1st Bn, 28th Inf		COL Paul F. Brain LTC Richard W. Anson LTC Howard F. Stone LTC Gus H. Watt		1st Brigade 1st Bn(Abnl), 327th Inf 2d Bn (Abnl), 327th Inf 2d Bn (Abnl), 302d Inf 3d Bn (Abnl), 506th Inf ^{1/}		COL John D. White LTC Jeremiah J. Brophy LTC Richard F. Fischer LTC Roy J. Young LTC Joseph N. Jagers	
2d Brigade 1st Bn, 16th Inf 1st Bn, 18th Inf 2d Bn, 18th Inf		COL Eyle W. Bowie LTC William E. Panton LTC Thomas R. Finley LTC George E. Williams		2d Brigade 1st Bn(Abnl), 501st Inf 2d Bn (Abnl), 501st Inf 1st Bn(Abnl), 502d Inf		COL Raymond L. Knappe LTC William B. Middlemass LTC Bobby F. Brashers LTC Robert E. Keener	
3d Brigade 2d Bn (Mech), 2d Inf 1st Bn (Mech), 16th Inf 2d Bn, 28th Inf		COL Elmer D. Pendleton LTC Lee D. Brown LTC David C. Martin LTC Richard W. Hobbs		3d Brigade 3d Bn(Abnl), 187th Inf 1st Bn(Abnl), 506th Inf 2d Bn (Abnl), 506th Inf		COL William J. Bradley LTC Herbert Y. Schandler LTC David R. Pinney LTC Howard G. J. Crowell	
1st Sqdn, 4th Cav		LTC Frederic J. Brown		160th Avn Gp 2d Sqdn (Abnl), 17th Cav		COL Christopher B. Sincialr LTC LaVere M. Bindrup	
1st Cav Div (Abnl) Asst Div Commander Asst Div Commander Chief of Staff Div Arty Commander Spt Comd Commander		MG Elvy B. Roberts BG Robert M. Shoemaker BG George W. Casey (P) COL Joseph P. Kingston COL Morris J. Brady COL Tom N. Nicholson		23d Inf Div Asst Div Commander Asst Div Commander Chief of Staff Div Arty Commander Spt Comd Commander		MG Lloyd B. Ramsey BG Edwin L. Powell, Jr. BG John W. Donaldson COL Thomas H. Tackaberry COL Leslie B. Hardy COL Kendrick B. Barlow	
1st Brigade 2d Bn (Abnl), 5th Cav 1st Bn (Abnl), 8th Cav 1st Bn (Abnl), 12th Cav		COL Joseph E. Collins LTC John R. Witherell LTC William J. McCloskey LTC Roderic E. Ordway		11th Inf Brigade 3d Bn, 1st Inf 4th Bn, 3d Inf 1st Bn, 20th Inf 4th Bn, 21st Inf		COL Hugh F. T. Hoffman LTC Leslie J. Stottle LTC Stanley V. Wielga LTC Arthur F. Fischer LTC George R. H. Johnson	
2d Brigade 1st Bn (Abnl), 5th Cav 2d Bn (Abnl), 7th Cav 2d Bn (Abnl), 8th Cav		COL Edward C. Meyer LTC James L. Anderson LTC Robert Hannas LTC Michael J. Conrad		196th Inf Brigade 2d Bn, 1st Inf 3d Bn, 21st Inf 4th Bn, 31st Inf		COL James M. Lee LTC Francis A. Nerone LTC Robert C. Bacon LTC Kenneth L. Skaer	
3d Brigade 1st Bn (Abnl), 7th Cav 5th Bn (Abnl), 7th Cav 2d Bn (Abnl), 12th Cav		COL Robert C. Kingston LTC Robert L. Drudik LTC Sanders A. Cortner LTC Harold E. Iverson		198th Inf Brigade 1st Bn, 6th Inf 1st Bn, 46th Inf 5th Bn, 46th Inf 1st Bn, 52d Inf		COL Joseph C. Clemens LTC H. Norman Schwarzkopf LTC Peter J. Foss LTC Melvin C. Snyder, Jr. LTC Arthur E. Brown, Jr.	
11th Avn Gp 1st Sqdn (Abnl), 9th Cav		COL Kenneth D. Mertel LTC James W. Booth		25th Inf Div Asst Div Commander Asst Div Commander Chief of Staff Div Arty Commander Spt Comd Commander		MG Harris W. Hollis BG Michael J. L. Greene BG Thomas J. Camp, Jr. COL James M. Connell COL Dan D. Stedham COL Robert E. Hamerquist	
4th Inf Div Asst Div Commander Asst Div Commander Chief of Staff Div Arty Commander Spt Comd Commander		MG Glenn D. Walker BG Jack MacFarlane BG John G. Wheelock, III COL Joseph E. McCarthy COL Edward F. Gudge, Jr. COL John E. Culin		1st Brigade 4th Bn, 9th Inf 2d Bn, 14th Inf 4th Bn (Mech), 23d Inf		COL Paul J. Mueller, Jr. LTC Forest S. Ritzgers, Jr. LTC Donald O. Crutchley LTC James E. Coggins	
1st Brigade 1st Bn, 8th Inf 3d Bn, 8th Inf 3d Bn, 12th Inf		COL Harold D. Yow LTC Richard E. Mack LTC Franklin D. Hicks LTC John W. Foss		2d Brigade 1st Bn (Mech), 5th Inf 1st Bn, 27th Inf 2d Bn, 27th Inf		COL Ennis C. Whitehead LTC Ted G. Westerman LTC William L. Martin LTC George A. Custer	
2d Brigade 2d Bn (Mech), 8th Inf 1st Bn, 12th Inf 1st Bn, 22d Inf		COL William E. Conger LTC Charles E. Thomann LTC John B. Cottingham LTC Michael P. Juvenal		3d Brigade 2d Bn, 12th Inf 2d Bn (Mech), 27d Inf 3d Bn, 22d Inf		COL Olin E. Smith LTC Burton J. Wolrath LTC John R. Parker LTC Warren A. Jones	
3d Brigade 1st Bn, 14th Inf 1st Bn, 35th Inf 2d Bn, 35th Inf		COL Gilbert Procter, Jr. LTC Andrew M. Simko LTC Cliff R. High LTC Dwight L. Adams		3d Sqdn, 4th Cav 2d Bn, 34th Arm		LTC Garwin A. Mitchell LTC William M. Greenberg	
1st Sqdn, 10th Cav 1st Bn, 69th Arm		LTC William J. Moran LTC James L. Marini					

^{1/} OPCIN to the 1st Bde, 4th Inf Div.

DATE FOR REMOVAL OF PROTECTIVE
MARKINGS CANNOT BE PREDETERMINED.

26-3

Unclassified

UNCLASSIFIED

3 FEBRUARY 1970

GENERAL OFFICERS AND COMMANDERS OF MAJOR UNITS AND MANEUVER BATTALIONS

AND
DIVISION CHIEFS OF STAFF

<u>1st Bde 5th Int Div (Mech)</u> 1st Bn, 11th Inf 1st Bn (Mech), 61st Inf 1st Bn, 77th Arm	BG William A. Burke LTC James D. Morndon LTC John W. Swaren, Jr. LTC Niven J. Baird	<u>I FFV Arty</u> 32d Arty Gp I FFV Prov Arty Gp	COL Charles M. Hall (P) COL Robert E. Dingeman COL Francis A. Bowers
<u>199th Inf Brigade</u> Deputy Commander 2d Bn, 3d Inf 3d Bn, 7th Inf 4th Bn, 12th Inf 5th Bn, 12th Inf	BG William R. Bond COL Robert W. Soltan LTC Benjamin F. Ivey, Jr. LTC John W. Crancer LTC John R. Black LTC David A. Beckner	<u>II FFV Arty</u> 23d Arty Gp	BG Francis J. Roberts COL Joseph N. Hearin, Jr.
<u>173d Abn Brigade</u> Deputy Commander 1st Bn, 503d Abn Inf 2d Bn, 503d Abn Inf 3d Bn, 503d Abn Inf 4th Bn, 503d Abn Inf	BG Hubert S. Cunningham COL Elmer R. Ochs LTC Manley H. Cosper, Jr. LTC George W. Krause LTC Brutus A. Lowery, Jr. LTC Paul S. Lawrence	<u>XXIV Corps Arty</u> 108th Arty Gp	COL Robert C. Hixon (P) COL Roscoe C. Cartwright
<u>3d Bde 9th Inf Div</u> 6th Bn, 31st Inf 2d Bn (Mech), 47th Inf 2d Bn, 60th Inf 5th Bn, 60th Inf	COL Andrew J. Gatsis LTC Gerald J. Carlson LTC John H. Claybrook LTC William N. Ciccolo LTC Davant T. Williams	<u>18th Engr Brigade</u> 35th Engr Gp 45th Engr Gp 937th Engr Gp	BG John W. Morris COL Harry A. Griffith COL William R. Wray COL Carroll E. Adams, Jr.
<u>11th Arm Cav Regt</u> 1st Recon Sqdn 2d Recon Sqdn 3d Recon Sqdn	COL Donn A. Starry LTC John M. Norton LTC Grail L. Brookshire LTC George Hoffmaster	<u>20th Engr Brigade</u> 34th Engr Gp 79th Engr Gp 159th Engr Gp	COL Edwin T. O'Donnell (P) COL John E. Sterling COL Amos L. Wright COL Joseph K. Bratton
<u>5th Spec Forces Gp</u>	COL Michael D. Healy	<u>1st Avn Brigade</u> Dep Commanding General 12th Avn Gp 16th Avn Gp 17th Avn Gp 164th Avn Gp 165th Avn Gp	BG George W. Putnam, Jr. Vacant COL John C. Hughes COL Delbert L. Townsend COL William R. McNowell COL William J. Maddox COL William D. Proctor
<u>1st Sqdn, 1st Cav</u> <u>2d Sqdn, 1st Cav</u> <u>3d Sqdn, 5th Cav 1/</u>	LTC Richard G. Graves LTC Robert G. Bond LTC William N. Bradberry, Jr.	<u>1st Sig Bde (USASTRATCOM)</u> Dep Commanding General 2d Sig Gp 21st Sig Gp 160th Sig Gp Reg Comm Gp 12th Sig Gp	MG Thomas M. Rienzi BG Jack A. Albright COL Edward D. McCarres COL James P. Mattern COL Bernard Pankowski COL John E. Hoover COL Dorward W. Ogden, Jr.
<u>7th Sqdn, 1st Air Cav</u> <u>3d Sqdn, 17th Air Cav</u> <u>7th Sqdn, 17th Air Cav</u>	LTC Ronald T. Walker LTC Robert A. Arnet LTC George S. Murry	<u>44th Med Brigade</u> 43d Med Gp 55th Med Gp 67th Med Gp 68th Med Gp	BG David E. Thomas COL Maurice S. Berbery COL Darl E. Vander Ploeg COL Daniel W. Pratt COL Merle D. Thomas
<u>1st Bn (Mech), 50th Inf</u>	LTC Robert H. Luck	<u>18th MP Brigade</u> 16th MP Gp 89th MP Gp 8th MP Gp	COL Wallace K. Wittwer COL Albert R. Escola COL Angus B. MacLean COL James D. Tynan
		<u>1st Log Command</u> Deputy Commander USA Spt Coand, Cam Ranh Bay USA Spt Coand, Da Nang USA Spt Coand, Saigon USA Spt Coand, Qui Nhon	MG Walter J. Woolwine BG Hugh A. Richeson COL Henry R. Del Mar (P) COL Homer D. Smith, Jr. COL Harold B. Gibson, Jr. (P) BG Albert E. Hunter
		<u>4th PSYOP Gp</u>	COL Taro Katagiri
		<u>34th Gen Spt Gp</u>	COL Samuel G. Cockerham
		<u>507th Trans Gp</u>	COL Henry H. Boltz, Jr.
		<u>509th Radio Rsch Gp</u>	COL William W. Higgins
		<u>525th MI Gp</u>	COL William H. Patterson

PRINCIPAL COMMANDERS OF FREE WORLD MILITARY FORCES

<u>Australian Army Volunteer Force, RVN</u> 1st Australian Task Force, RVN 6th Bn 5th Bn 9th Bn	MG R. A. Hay BRIG S. R. Weir LTC D. Butler LTC C. M. Khan LTC E. R. Philip	<u>New Zealand Army Forces, RVN</u>	LTC K. C. Fenton
<u>Republic of Korea Forces, RVN</u> ROK Capital Div ROK 9th Div 2d ROK Marine Bde	LTC Yi, Se-ho MG Yun, Pil-yong MG Yun, Chang-hun MG Yi, Tong Ho	<u>Royal Thai Forces, RVN</u> Royal Thai Army Vol Force, RVN 1st Bde 2d Bde	MG Chaveng Youngcharoen MG Swasdi Makkaroon SP COL Naronkrit Maharakkhara SP COL Aroon Tamatasin

1/ Attached to 1st Bde, 5th Mech per USARV GO 1836, 21 May 69; currently OPCON 101st Abn Div.

DATE FOR REMOVAL OF PROTECTIVE
MARKINGS CANNOT BE PREDETERMINED.

UNCLASSIFIED

Unclassified

UNCLASSIFIED

NO CHANGE

NO CHANGE

3 FEBRUARY 1970

SELECTED ADVISORS IN RVN

I CTZ
Quang Nam
Quang Ngai
Quang Tin †
Quang Tri †
Thua Thien †

BG Henry J. Muller, Jr.
LTC William R. Blakely *
LTC Richard A. Hippler (P) *
LTC Mebane G. Stafford *
LTC Elmer L. Birk (P) *
COL John W. Chism *

II CTZ
Binh Dinh †
Binh Thuan
Darlac †
Khanh Hoa
Kontum †
Lam Dong †
Ninh Thuan
Phu Bon
Phu Yen
Pleiku †
Quang Duc †
Tuyen Duc

BG Gordon J. Duquemin **
COL Billy J. Mendheim *
LTC Carleton J. Robinson *
LTC Timothy G. Gannon *
LTC Frederick L. Wegley *
COL Oliver W. Dillard *
COL Lawrence D. Thompson *
LTC Lewis H. Ham, Jr. *
LTC Robert R. Hicks (P) *
LTC Thomas M. Sievers
COL Carl A. Lee *
LTC Ralph W. Julian *
LTC Paul R. Hilty, Jr. *

III CTZ
Ben Hoa
Binh Duong †
Binh Long
Binh Tuy †
Gia Dinh
Hau Nghia †
Long An †
Long Khanh †
Phuoc Long †
Phuoc Tuy
Tay Ninh

BG Dennis P. McAuliffe **
LTC Kenneth T. Trinkler *
LTC Raymond L. Fleigh, Jr. *
LTC Robert A. Farr *
LTC Richard C. Ewan, Jr. *
COL Roy W. Burley
COL Jack K. Weissinger *
COL Alfred L. Sanderson
LTC Joseph J. Scott, Jr. (P) *
LTC Robert T. Hayden *
LTC John J. Bacchi *
LTC James C. Cloud (P) *

IV CTZ (CG, Delta Mil Asst Comd)
Deputy Senior Advisor (DCG, DMAC)
An Giang
An Xuyen †
Ba Xuyen
Bac Lieu
Chau Doc
Chuong Thien †
Dinh Tuong †
Go Cong
Kien Giang †
Kien Hoa
Kien Phong †
Kien Tuong †
Phong Dinh †
Sa Dec
Vinh Binh †
Vinh Long †

MG Hal D. McCown
BG George G. Cantlay
LTC Warren P. Schilling (P) *
LTC Donald E. Sawyer *
LTC Edward E. Matney *
COL Bert H. Herigstad *
LTC Horace L. Hunter, Jr. *
LTC Thomas Le Vasseur *
COL Joy K. Vallery *
LTC John D. Howard (P) *
LTC Billy M. Stanberry *
LTC Amil J. Eckhart *
LTC Clement H. Will (P) *
COL Ernest P. Terrell, Jr. *
COL Lester M. Conger *
LTC Lynn L. Lee *
COL Richard W. Ellison *
LTC Roland D. Tausch *

ARVN DIVISIONS

1st Div
2d Div
5th Div
7th Div
9th Div
18th Div
21st Div
22d Div
23d Div
25th Div
Abn Div

COL Jesse L. Wheeler, Jr.
COL Henry S. Sachors
COL John G. Hayes
COL William B. Pegraf
COL James W. Cavender
COL John E. Tyler
COL Louis F. Felder
COL John T. Hodes
COL William E. Zook
COL George B. Robbins
COL Charles F. Greer

SPECIAL TACTICAL ZONES

Capitol Military District
44th STZ
24th STZ
Quang P's SZ

Vacant
COL Robert W. Hassinger
COL Philip S. Day, Jr.
COL Warren P. Allen

- * Member Province Senior Advisor/Deputy Senior Advisor Program.
- ** The Senior US military officer in each Corps Tactical Zone is also the Senior Advisor. Deputies only are listed here for I, II and III Corps. For IV Corps both the Deputy and Senior Advisor are listed.
- † Indicates province in which the military advisor is also the Province Senior Advisor.

DATE FOR REMOVAL OF PROTECTIVE MARKINGS CANNOT BE PREDETERMINED.

FO [REDACTED] [REDACTED]

UNCLASSIFIED

Unclassified

UNCLASSIFIED

DEPLOYMENTS AND REDEPLOYMENTS

LISTING OF SELECTED UNITS IN RVN

(INCLUDES INF, ARM, ARTY, AND AVIATION; AND UNITS OF BN OR LARGER SIZE OF ENGR, MP, AND SIG)

3 FEBRUARY 1970

UNIT	ACTIV DATE	CLOSED IN RVN	UNIT	ACTIV DATE	CLOSED IN RVN
HQ FFV/CORPS			101st Abn Div (Abnl) (Cont)		
1 FFV (Nha Trang)	Nov 65	V	2d Bde (Van Xa)	*	Dec 67
11 FFV (Long Binh)	Jan 66	Mar 66	17501 Inf (Abnl)	*	Dec 67
XXIV Corps (Phu Bai)	Aug 68**	V	27501 Inf (Abnl)	*	Dec 67
DIVISIONS			17502 Inf (Abnl)	*	Dec 67
1st Inf Div (Lai Khe)	*		3d Bde (Phong Dien)	*	Dec 67
1st Bde (Dau Tieng)			37187 Inf (Abnl)	*	Dec 67
172 Inf		Oct 65	17506 Inf (Abnl)	*	Dec 67
1726 Inf		Oct 65	27506 Inf (Abnl)	*	Dec 67 ^{1/}
1728 Inf		Oct 65	2717 Cav (Abnl)	Jul 68	Dec 67
2d Bde (Bear Cat/Thai Thien)			27319 Arty (105 T) (Abnl)	*	Dec 67
2716 Inf		Jul 65	27320 Arty (105 T) (Abnl)	*	Jul 65
1718 Inf		Jul 65	17321 Arty (105 T) (Abnl)	*	Dec 67
2718 Inf		Jul 65	326 Engr Bn (Abnl)	*	Nov 67
3d Bde (Lai Khe)			501 Sig Bn (Abnl) (-)	*	Dec 67
272 Inf (Mech)		Oct 65	2711 Arty (155 T)	*	Dec 66
1716 Inf (Mech)	*	Oct 65	4777 Arty (ARA)	Jul 68	Dec 68
2728 Inf		Oct 65	101st Avn Gp (Phu Bai) 2/	Jul 68	V
174 Cav		Oct 65	101 Avn Bn (Abnl) (3AvnCos, 1WpnCo)	Jul 68	V
175 Arty (105 T)		Oct 65	159 Avn Bn (Abnl) (3 Avn Cos)	Jul 68	V
876 Arty (155/8" T)		Oct 65	163 Avn Co (GS) (Abnl)	Jul 68	V
177 Arty (105 T)		Oct 65	158 Avn Bn (Aslt Hel) (3 Avn Cos, 1WpnCo)	Jul 68	Feb 69
2733 Arty (105 T)		Oct 65	23d Inf Div (Chu Lai)	Sep 67	V
173 Avn Co (Abnl) (Lt) (Atchd)	Sep 65	Mar 66	11th Inf Bde (Duc Pho)		
1 Avn Bn (w/2 Avn Cos)		Oct 65	371 Inf	Jul 66	Dec 67
1 Engr Bn		Nov 65	473 Inf	Jul 66	Dec 67
121 Sig Bn		Oct 65	1720 Inf	Jul 66	Dec 67
4th Inf Div (Pleiku)	*		4721 Inf	Nov 67	Apr 68
1st Bde (Pleiku/An Khe)			E71 Cav	Jul 66	Dec 67
178 Inf		Oct 66	196th Inf Bde (Chu Lai/Tuan Duong)		
3712 Inf		Oct 66	271 Inf	Sep 65	Aug 66
2d Bde (An Khe)			3721 Inf	Sep 65	Aug 66
278 Inf (Mech)		Aug 66	4731 Inf	Sep 65	Aug 66
378 Inf		Oct 66	F717 Cav	Sep 65	Aug 66
1712 Inf		Aug 66	198th Inf Bde (Chu Lai/Dong Le)		
1722 Inf		Aug 66	176 Inf	*	Oct 67
3d Bde (Pleiku)			1746 Inf	*	Oct 67
1714 Inf		Jan 66	5746 Inf	Oct 67	Mar 68
1735 Inf		Jan 66	1752 Inf	*	Oct 67
2735 Inf		Jan 66	H717 Cav	May 67	Oct 67
1710 Cav		Oct 66	6711 Arty (105 T)	Mar 67	Dec 67
1769 Arm		Mar 66	3782 Arty (105 T)	Sep 65	Aug 66
279 Arty (105 T)		Jan 66	1714 Arty (105 T)	*	Oct 67
5716 Arty (155/8" SP)		Oct 66	1782 Arty (155/8" SP)	Jan 68	Jul 68
6729 Arty (105 T)		Oct 66	3716 Arty (155 T)	*	Jun 67
4742 Arty (105 T)		Aug 66	3718 Arty (175/8" SP)	*	Oct 65
4 Avn Bn (w/2 Avn Cos)	Sep 66/Jan 67	Sep 66	123 Avn Bn	Dec 67	V
4 Engr Bn	Jul 66	Sep 66	26 Engr Bn	Dec 67	V
124 Sig Bn	Sep 66	Sep 66	523 Sig Bn	Jan 68	V
101st Abn Div (Abnl) (Hue-Phu Bai)	*		F78 Cav	Apr 68	V
1st Bde (Hue-Phu Bai)			25th Inf Div (Cu Chi)	*	
17327 Inf (Abnl)	*	Jul 65	1st Bde (Tay Ninh)		
27327 Inf (Abnl)	*	Jul 65	479 Inf		Apr 66
27502 Inf (Abnl)	*	Jul 65	2714 Inf		Apr 66
37506 Inf (Abnl) (Op Con 1st Bde)	Apr 67	Oct 67	4723 Inf (Mech)		Apr 66
4th Inf Div			2d Bde (Cu Chi)		
			175 Inf (Mech)		Jan 66
			1727 Inf		Jan 66
			2727 Inf		Jan 66

V Activated in-country.
 * In the force structure prior to 30 Jun 65.
 ** Succeeded Provisional Corps, RVN, which was activated in Mar 68.

NOTE: Location shown to the left of the slash is the unit's base camp; where the base camp location differs from the field command post location, the command post location is shown to the right of the slash. Organization of battalions within brigades shown is administrative.

1/ The 2717 Cav (Abn) closed RVN Dec 67; 2717 Cav (Abnl) was activated in RVN effective 1 Jul 69; troops A, B, and C/Air Cav closed RVN Mar 69.
 2/ Redesignated 101st Avn Gp on 24 Jun 69.

DOWNGRADED AT 3 YEAR INTERVALS
 DECLASSIFIED AFTER 12 YEARS
 DOD DIR 3770.10

26-6

UNCLASSIFIED

Unclassified

UNCLASSIFIED

DEPLOYMENTS AND REDEPLOYMENTS

LISTING OF SELECTED UNITS IN RVN

(INCLUDES INF, ARM, ARTY, AND AVIATION; AND UNITS OF BN OR LARGER SIZE OF ENGR, MP, AND SIG)

NO CHANGE

NO CHANGE

3 FEBRUARY 1970

UNIT	ACTIV DATE	CLOSED IN RVN	UNIT	ACTIV DATE	CLOSED IN RVN
<u>25th Inf Div (Cont)</u>					
<u>3d Bde (Cu Chi/Bao Trai)</u>					
2/12 Inf	*	Oct 66			
2/22 Inf (Mech)	*	Oct 66			
3/22 Inf	Nov 65	Oct 66			
3/4 Cav	*	Mar 66			
2/34 Arm	*	Sep 66			
1/8 Arty (105 T)	*	Jan 66			
7/11 Arty (105 T)	*	May 66			
3/13 Arty (155/B ¹ T)	*	Apr 66			
2/77 Arty (105 T)	*	Oct 66			
25 Avn Bn (w/2 Avn Cos)	*	Apr 66			
65 Engr Bn	*	Jan 66			
125 Sig Bn	*	Mar 66			
<u>1st Cav Div (Ambl) (Bien Hoa/Phuoc Vinh)</u>					
<u>1st Bde (Tay Ninh)</u>					
1/5 Cav (Ambl)	*	Sep 65			
1/8 Cav (Ambl)	*	Sep 65			
2/8 Cav (Ambl)	*	Sep 65			
2/12 Cav (Ambl)	Jul 65	Sep 65			
<u>2d Bde (Bien Hoa/Phuoc Vinh)</u>					
2/5 Cav (Ambl)	*	Sep 65			
5/7 Cav (Ambl)	Apr 66	Aug 66			
<u>3d Bde (Quan Loi)</u>					
2/7 Cav (Ambl)	*	Sep 65			
1/12 Cav (Ambl)	*	Sep 65			
1/7 Cav (Ambl)	*	Sep 65			
<u>11th Avn Gp (Bien Hoa/Phuoc Vinh)</u>					
227 Avn Bn (Ambl) (4 Avn Cos)	*	Sep 65			
228 Avn Bn (Ambl) (3 Avn Cos)	*	Sep 65			
229 Avn Bn (Ambl) (4 Avn Cos)	*	Sep 65			
11 Avn Co (GS) (Ambl)	*	Sep 65			
478 Avn Co (Hvy Hel) (Atchd)	*	Sep 65			
1/9 A1r Cav Sqdn	*	Sep 65			
2/19 Arty (105 T) (Ambl)	*	Oct 65			
2/20 Arty (Aer Rkt) (Ambl)	*	Oct 65			
1/21 Arty (105 T) (Ambl)	*	Oct 65			
1/77 Arty (105 T) (Ambl)	*	Oct 65			
1/30 Arty (155 T)	*	Nov 65			
6/82 Arty (Ambl)	*	Oct 65			
8 Engr Bn (Ambl)	*	Sep 65			
13 Sig Bn (Ambl)	*	Sep 65			
BRIGADES					
<u>1st Bde 5th Inf Div (Mech) (Quang Tri)</u>	*				
1/11 Inf		Jul 68			
1/61 Inf (Mech)		Jul 68			
1/77 Arm		Jul 68			
5/4 Arty (155 SP)		Jul 68			
A/7 Engr Bn		Jul 68			
A/4/12 Armd Cav		Jul 68			
<u>199th Inf Bde (Long Binh/Xuan Loc)</u>					
2/3 Inf	Jun 66	Dec 66			
3/7 Inf	Jun 66	Dec 66			
4/12 Inf	Jun 66	Dec 66			
5/12 Inf	Nov 67	Apr 68			
2/40 Arty (105 T)	Jun 66	Dec 66			
0/17 Cav	Jun 66	Dec 66			
			BRIGADES (Cont)		
			<u>173d Abn Bde (Bong Son)</u>		
			1/503 Abn Inf	*	May 65
			2/503 Abn Inf	*	May 65
			3/503 Abn Inf	Apr 67	Oct 67
			4/503 Abn Inf	Apr 66	Jun 66
			3/319 Arty (105 T)	*	May 65
			0/16 Arm	*	May 65
			E/17 Cav	*	May 65
			<u>3d Bde 9th Inf Div (Tan An) I/</u>		
			6/31 Inf	Nov 67	Apr 68
			2/47 Inf (Mech)	Feb 66	Jan 67
			2/60 Inf	Feb 66	Dec 66
			5/60 Inf	Feb 66	Dec 66
			2/4 Arty (105 T)	Feb 66	Jan 67
			0/3/5 Cav	Feb 66	Jan 67
			ARMORED CAVALRY REGIMENTS		
			<u>11th Armd Cav Regt 2/ (Bien Hoa/Quan Loi)</u>	*	
			1st Recon Sqdn		Sep 66
			2d Recon Sqdn		Sep 66
			3d Recon Sqdn		Sep 66
			SPECIAL FORCES GROUPS		
			5th SF Gp, 1st SF (Nha Trang)	*	Apr 65
			ARMED CAVALRY SQUADRONS		
			<u>1/1 Cav (Chu-Lai) (Op Con 23d Inf Div)</u>	*	Aug 67
			2/1 Cav (Song Mao) (Op Con TF South)	*	Aug 67
			3/5 Cav (Ashau) (Op Con 101st Abn Div (Ambl))	Feb 66	Jan 67
			SEPARATE INFANTRY BATTALIONS		
			1/50 Inf (Mech) (Phan Thiet) (Op Con 1 FFV TF South)	*	Sep 67
			TF South (Phan Thiet)	Jul 68	

V Activated in-country
 * In the force structure prior to 30 Jun 65.
 1/ Op Con 25th Inf Div effective 26 Jul 69.
 2/ Op Con to the 1st Cav Div.
 3/ Attached to 1st Bde, 5th Mech per USARV GO 1836, 21 May 69.

NOTE: Location shown to the left of the slash is the unit's base camp; where the base camp location differs from the field command post locations, the command post location is shown to the right of the slash. Organization of battalions within the brigades shown is administrative.

DOWNGRADED AT 3 YEAR INTERVALS
 DECLASSIFIED AFTER 15 YEARS
 SDD DIR 310,10

26-**UNCLASSIFIED**

Unclassified

UNCLASSIFIED

DEPLOYMENTS AND REDEPLOYMENTS

LISTING OF SELECTED UNITS IN RVN

(INCLUDES INF, ARM, ARTY, AND AVIATION; AND UNITS OF BN OR LARGER SIZE OF ENGR, MP, AND SIG)

3 FEBRUARY 1970

UNIT	ACTIV DATE	CLOSED IN RVN	UNIT	ACTIV DATE	CLOSED IN RVN
COMBAT SUPPORT UNITS:					
Field Artillery					
1 FFV Arty (Nha Trang)	Aug 65	Nov 65	937 Engr Gp (Cbt) (Pleiku)	*	Aug 65
52 Arty Gp (Pleiku)	*	Jun 66	19 Engr Bn (Cbt)	*	Sep 65
1 FFV Prov Arty Gp	Apr 69	V	20 Engr Bn (Cbt)	*	Jan 66
3/6 Arty (105 SP)	*	Jun 66	299 Engr Bn (Cbt)	*	Oct 65
7/13 Arty (105 T)	Jun 66	Oct 66	84 Engr Bn (Const)	*	Jun 65
6/14 Arty (175 SP)	*	Oct 65	815 Engr Bn (Const)	Feb 66	Apr 67
7/15 Arty (8" SP)	*	Jul 67	20 Engr Bde (Blen Hoa)	May 67	Aug 67
2/17 Arty (105 T)	*	Sep 65	34 Engr Gp (Const) (Binh Thuy)	Sep 66	Mar 67
5/22 Arty (175 SP)	May 67	Dec 67	35 Engr Bn (Cbt)	*	Nov 66
5/27 Arty (105 T)	*	Oct 65	36 Engr Bn (Const)	Jul 66	Sep 67
6/32 Arty (8" SP)	*	Mar 67	69 Engr Bn (Const)	Jul 66	May 67
1/92 Arty (155 T)	*	Mar 67	93 Engr Bn (Const)	Jul 66	Jun 67
			79 Engr Gp (Const) (Long Binh)	Feb 66	Jul 66
11 FFV Arty (Long Binh) 1/	Jan 66	Mar 66	168 Engr Bn (Cbt)	*	Nov 65
23 Arty Gp (Phu Loi)	*	*	588 Engr Bn (Cbt)	*	Nov 65
7/8 Arty (8" SP)	*	Jun 67	34 Engr Bn (Const)	Jul 66	May 67
7/9 Arty (105 T)	*	Oct 66	554 Engr Bn (Const)	Feb 66	Apr 67
2/12 Arty (155 T)	Sep 69	V	159 Engr Gp (Const) (Long Binh)	*	Oct 65
2/13 Arty (105 T)	*	Oct 65	31 Engr Bn (Cbt)	*	Apr 68
1/27 Arty (155 SP)	Oct 66	Apr 67	46 Engr Bn (Const)	*	Sep 65
6/27 Arty (8" SP)	*	Nov 65	62 Engr Bn (Const)	*	Aug 65
2/32 Arty (175 SP)	*	Nov 65	92 Engr Bn (Const)	*	May 67
2/35 Arty (155 SP)	*	Jun 66	169 Engr Bn (Const)	*	Jun 66
5/42 Arty (155 T)	Jan 67	Apr 68	US Army Engr Const Agency RVN (Long Binh)	May 68	V
F/16 Arty (155 T)	*	V	Signal		
			1st Sig Bde (USASTRATCOM) (Long Binh)	Apr 66	V
XXIV Corps Arty (Phu Bai) 2/	Aug 68**	V	2d Sig Gp (Long Binh)	*	Jun 65
108 Arty Gp (Dong Ha)	May 67	Oct 67	36 Sig Bn (Cbt Area)	*	Nov 66
8/4 Arty (175/8" SP)	Mar 67	Aug 67	39 Sig Bn (Spt)	*	Mar 62
1/83 Arty (175/8" SP)	*	Nov 66	52 Sig Bn (Spt)	Aug 66	V
2/94 Arty (8" SP)	Jun 66	Oct 66	86 Sig Bn (Spt)	Jun 66	Sep 66
6/33 Arty (105 T)	Sep 67	Feb 68	972 Sig Bn	May 68	Oct 68
			21 Sig Gp (Nha Trang)	*	Jun 66
Air Defense Artillery			41 Sig Bn (Cbt Area)	*	Jul 65
5/2 Arty (40mm AWSP) (Long Binh)	Jun 66	Nov 66	43 Sig Bn (Spt)	Aug 66	V
4/60 Arty (40mm AWSP) (An Khe)	Jun 66	Mar 67	73 Sig Bn (Spt)	*	Jul 66
6/55 Arty (50 Cal MG) (Chu Lai)	Aug 67	Feb 68	459 Sig Bn (Cbt Area)	*	Oct 66
6/65 Arty (50 Cal MG) (Dong Ha)	Mar 66	Nov 66	160 Sig Gp (Long Binh)	*	May 67
1/44 Arty (40mm AWSP) (Dong Ha)	Mar 66	Nov 66	40 Sig Bn (Const)	*	Sep 66
E/41 Arty (50 Cal MG) (Anh Khe)	Jun 66	Mar 67	44 Sig Bn (Spt)	Aug 66	V
D/71 Arty (50 Cal MG) (Long Binh)	Jun 66	Nov 68	69 Sig Bn (Army)	*	Nov 65
			Regional Comm Gp (Salgon)	Jul 65	V
Engineers			361st Sig Bn	Jun 69	V
18 Engr Bde (Dong Ba Thin) 3/	Jul 65	Sep 65	369th Sig Bn	Jun 69	V
35 Engr Gp (Const) (Cam Ranh Bay)	*	Jun 65	USASTRATCOM Fac - Phu Lam	Nov 64	V
577 Engr Bn (Const)	*	Jul 66	USASTRATCOM Fac - Da Mang	Aug 66	V
589 Engr Bn (Const)	Jan 66	Apr 67	USASTRATCOM Fac - Nha Trang	Nov 65	V
864 Engr Bn (Const)	*	Jun 65	12 Sig Gp (Phu Bai)	Jun 69	V
			37 Sig Bn (Spt)	Aug 66	V
45 Engr Gp (Const) (Phu Bai)	Feb 66	Jun 66	63 Sig Bn (R&C)	Jul 67	Mar 68
14 Engr Bn (Cbt)	*	Oct 66	53 Sig Bn (Long Binh)	*	Jun 66
27 Engr Bn (Cbt)	*	Oct 66	54 Sig Bn (Nha Trang)	*	Sep 65
39 Engr Bn (Cbt)	*	Jan 66	Military Police		
			18th MP Bde (Long Binh)	May 66	Sep 66
			16th MP Gp (Nha Trang)	May 66	Sep 66
			93 MP Bn	Jun 66	Aug 66
			97 MP Bn	Jul 66	Aug 66
			504 MP Bn	*	Aug 65

V Activated in-country.

* In the force structure prior to 30 Jun 65.

** Succeeded Provisional Corps Arty RVN, which was activated in Mar 68.

1/ 3/197 Arty (155 T) deployed to CONUS on 3 Sep 69; 6/15 Arty Bn (105, T) Color and Guidon Det redeployed to CONUS on 20 Nov 69.

2/ 2/138 Arty (155 SP) redeployed to CONUS on 10 Oct 69; 1/40 Arty Bn (105 SP) Color and Guidon Det redeployed to CONUS on 19 Nov 69.

3/ 70th Engr Bn (Cbt) Color and Guidon Det redeployed to CONUS on 29 Nov 69 for inactivation.

DOWNGRADED AT 5 YEAR INTERVALS

DECLASSIFIED AFTER 15 YEARS

DDO DIR 1206.11

UNCLASSIFIED

Unclassified

UNCLASSIFIED

DEPLOYMENTS AND REDEPLOYMENTS

LISTING OF SELECTED UNITS IN RVN

(INCLUDES INF, ARM, ARTY, AND AVIATION; AND UNITS OF BN OR LARGER SIZE OF ENG, MG, AND BTR)

3 FEBRUARY 1970

UNIT	ACTIV DATE	CLOSED IN RVN	UNIT	ACTIV DATE	CLOSED IN RVN
Military Police (Cont)			Aviation (Cont)		
8ch MP Gp (CI) (Long Binh)	Aug 68	V	10th Cmbt Avn Bn (Dong Ba Thin)	Aug 65	Oct 65
89 MP GP (Long Binh)	Mar 66	V	48th Aslt Hel Co (Ninh Hoa)	Jul 65	Nov 65
92 MP Bn	*	Apr 66	92d Aslt Hel Co	Feb 67	Nov 67
95 MP Bn	Nov 65	Apr 66	155th Aslt Hel Co (Ban Me Thuot)	Jul 65	Oct 65
716 MP Bn	*	Mar 65	192d Aslt Hel Co (Phan Thiet)	Nov 66	Oct 67
720 MP Bn	*	Oct 66	243d Aslt Spt Hel Co	Dec 66	Nov 67
			281st Aslt Hel Co (Nha Trang)	Oct 65	Jun 66
Aviation 1/ 2/			52d Cmbt Avn Bn (Pleiku)	*	Mar 63
1st Avn Bde (Long Binh)	May 66	May 66	57th Aslt Hel Co (Nontum)	Feb 67	Oct 67
5th Avn Det	*	Oct 64	119th Aslt Hel Co (An Khe)	*	V
165th Avn Gp (Long Binh)	Feb 69	V	170th Aslt Hel Co	Sep 65	Dec 65
120th Aslt Hel Co	*	Mar 65	179th Aslt Spt Hel Co	Dec 65	Jun 66
125th ATC Co (Bien Hoa)	*	Jul 65	189th Aslt Spt Hel Co	Nov 66	May 67
Comd Acft Co (Long Thanh)	*	V	361st Aerial Wpns Co (Escort) ^{2/}	Nov 67	Apr 68
12th Cmbt Avn Gp (Long Binh)	*	Aug 65	223d Cmbt Avn Bn (Qui Nhon)	May 66	V
11th Cbt Avn Bn (Phu Loi)	Aug 65	Nov 65	18th Util Apl Co (OA)	*	Feb 62
128th Aslt Hel Co	Jul 65	Oct 65	183d Recon Apl Co (Dong Ba Thin)	Jan 66	Jun 66
173d Aslt Hel Co (Lai Khe)	Sep 65	Mar 66	185th Recon Apl Co (Ban Me Thuot)	Jan 67	Jun 67
205th Aslt Spt Hel Co	Nov 66	May 67	203d Recon Apl Co (Phu Hiep)	Apr 67	Oct 67
213th Aslt Spt Hel Co	Jun 66	Jan 67	219th Recon Apl Co (Pleiku)	Mar 65	Jun 65
145th Cmbt Avn Bn (Bien Hoa)	Sep 63	V	225th Surv Apl Co (Phu Hiep)	Jul 66	May 67
68th Aslt Hel Co	Jul 65	Nov 65	268th Cmbt Avn Bn (Phu Hiep)	Feb 67	May 67
118th Aslt Hel Co	*	P	61st Aslt Hel Co (An Son)(Lane)	Feb 67	Nov 67
190th Aslt Hel Co	Oct 66	Aug 67	129th Aslt Hel Co (An Son) AHP	Jul 65	Oct 65
334th Aerial Wpns Co	Nov 66	V	134th Aslt Hel Co	Feb 67	Nov 67
210th Cmbt Avn Bn (Long Thanh)	Feb 67	Apr 67	180th Aslt Hel Co	Mar 66	Oct 66
25th Avn Co (Corps) (Long Binh)	Mar 67	Oct 67	196th Aslt Spt Hel Co (An Son)	Jul 65	Mar 67
54th Util Apl Co (Yung Tau)	*	Sep 65	355th Hvy Hel Co	Jul 67	Jan 68
73d Surv Apl Co (Yung Tau)	*	May 63	238th Aerial Wpns Co (KD)(An Khe)	Jul 68	Mar 68
74th Recon Apl Co (Phu Loi)	*	Mar 65	7th Sqdn 17th Air Cav (Pleiku) ^{2/}	Nov 66	Oct 67
184th Recon Apl Co (Phu Loi)	Jan 66	Aug 66	164th Cmbt Avn Gp (Can Tho)	Dec 67	V
222d Cmbt Avn Bn (Bear Cat)	May 66	V	13th Cmbt Avn Bn (Soc Trang)	*	Sep 64
117th Aslt Hel Co (Long Binh)	Nov 66	Jun 63	121st Aslt Hel Co	*	V
195th Aslt Hel Co (Long Binh)	Nov 67	Nov 67	162d Aslt Hel Co (Can Tho)	Sep 65	Feb 66
240th Aslt Hel Co	Nov 66	May 67	191st Aslt Hel Co (Can Tho)	Dec 66	May 67
273d Hvy Hel Co (Long Binh)	Apr 67	Dec 67	221st Recon Apl Co	Mar 65	V
269th Cmbt Avn Bn (Cu Chi)	Jul 66	Jan 67	336th Aslt Hel Co	Nov 66	V
116th Aslt Hel Co	Jul 65	Oct 65	214th Cmbt Avn Bn (Vinh Long)	*	May 63
187th Aslt Hel Co (Tay Ninh)	Sep 66	Mar 67	114th Aslt Hel Co	Nov 66	Nov 67
242d Aslt Spt Hel Co (Dong Ba Thin)	Oct 66	Aug 67	135th Aslt Hel Co (Bear Cat)	Nov 66	V
3d Sqdn 17th Air Cav (Di An)	Nov 66	Oct 67	175th Aslt Hel Co	Feb 67	Jul 67
16th Cmbt Avn Gp (Chu Lai) ^{2/}	Dec 67	V	199th Recon Apl Co	Nov 66	Nov 66
14th Cmbt Avn Bn (Chu Lai) ^{2/}	*	Oct 64	335th Aslt Hel Co (Bear Cat)	Nov 66	Nov 66
71st Aslt Hel Co	*	Sep 66	307th Cmbt Avn Bn (Can Tho)	Dec 67	V
132d Aslt Spt Hel Co	Oct 67	May 68	147th Aslt Spt Hel Co (Yung Tau)	Jul 65	Nov 65
174th Aslt Hel Co (Duc Pho)	Oct 65	Apr 66	235th Aerial Wpns Co	Dec 66	Nov 67
176th Aslt Hel Co	Oct 65	Feb 67	244th Surv Apl Co	Sep 66	Jul 67
178th Aslt Spt Hel Co	Sep 65	Mar 66	271st Aslt Spt Hel Co	Apr 67	Feb 68
212th Cmbt Avn Bn (Da Nang)	Mar 67	Jul 67	7th Sqdn 1st Air Cav (Vinh Long)	Nov 66	Oct 67
21st Recon Apl Co (Chu Lai)	Jan 67	Jun 67	Other Aviation Units		
131st Surv Apl Co (Hue/Phu Bai)	Jul 65	V	224th Avn Bn (RR)(USASA)(Tan Son Nhut)	Jun 66	V
220th Recon Apl Co (Hue/Phu Bai)	*	Jul 65	138 Avn Co (RRU)(Can Tho)	Jun 66	V
245th Surv Apl Co	Sep 66	Oct 67	144 Avn Co (RRU)(Nha Trang)	Jun 66	V
282d Aslt Hel Co	Oct 65	Jun 66	146 Avn Co (RRU)(Tan Son Nhut)	Jun 66	V
62d Corps Avn Co (Hue/Phu Bai)	Mar 68	V	156 Avn Co (RRU)(Can Tho)	Jun 66	V
17th Cmbt Avn Gp (Nha Trang)	Dec 65	V	1 ASA Co (Avn)(Cam Ranh Bay)	*	Jun 67
201st Corps Avn Co	Mar 67	Oct 67	509th Radio Research Group (Saigon)	Jun 66	V

- ^{1/} In addition to the aviation companies listed, the following cavalry, artillery, and medical company-sized units are aircraft companies. 3 Air Cav troops of the 1/9 Cav, 1st Cav Div (Anbi); Trp D (Air Cav) of the 1/4 Cav, 1st Inf Div; Trp D (Air Cav) of the 3/4 Cav, 25th Inf Div; Trp D (Air Cav) of the 3/5 Cav, 9th Inf Div; Trp D of the 1/10 Cav, 4th Inf Div; Trp D (Air Cav), 1/1 Cav; Trp D (Air Cav), 2/1 Cav; 3 aerial rocket batteries of the 2/20 Arty (Aer Rlt) of the 1st Cav Div (Anbi); 3 air Cav troops of the 2/17 Cav, Air Cav Trp, 11th Armd Cav Regt; and two medical/two medical companies, Air Ambulance.
- ^{2/} Organic aviation companies are shown with major command.
- ^{3/} Scheduled for possible TDY missions (Duffle Bag) in Thailand.
- * In the force structure prior to 30 Jun 65.
- P Prior to Mar 65, exact date unknown.
- V Activated in-country.

DOWNGRADED AT 2 YEAR INTERVALS
DECLASSIFIED AFTER 11 YEARS
DDG DTR 8100.10

UNCLASSIFIED

Unclassified

UNCLASSIFIED

LANDING FORCE, SIXTH FLEET 3-69

7 FEBRUARY 1970

TF-61/62 CTG: LTCOL G. B. CRIST UNITS EMBARKED	STRENGTH				ARMS & EQUIPMENT	LOCATION ENROUTE GREECE
	USMC		USN			
	OFF	ENL	OFF	ENL		
BMT 2/6 (LTCOL G. B. CRIST)					31 7.62 MG 10 LVTP-5 6 105 HOW 5 90MM GUN TANK 5 ONTOS 8 81MM MORTARS 8 FLAME THROWERS 6 106MM RR	SHIPPING USS CAMBRIA (APA-36) USS LASALLE (LPD-3) USS RUSHMORE (LSD-14) USS WAHKIYAKUM (LST-1162)
2D BN, 6TH MAR	49	1030	4	33	21 MULES 32 MITES 22 2 1/2 TON TRUCKS 8 JEEPS 3 5 TON CARGO TRUCKS 9 3/4 TON UTIL TRUCKS 4 AMBULANCES 4 CRANES	
DET HQCO, 6TH MAR						SUPPLIES CLASS I CLASS II CLASS III CLASS IV CLASS V
BTRY "E", 2/10	9	124				
DET HQ BTRY, 2/10	2	10		2		
PLT CO "C", 2D AMTRAC BN	1	45				
PLT CO "B", 8TH MT BN		19				
PLT CO "C", 2D AT BN	1	21				
PLT CO "B", 2D ENGR BN		49				
PLT CO "A", 2D MED BN		10	1	9		
PLT CO "A", 2D TK BN	1	24				
PLT CO "A", 2D SP BN	1	49				
PLT CO "B", 2D RECON BN	1	24		1		
DET HQBN, 2D MARDIV		27				
DET 2D DENTAL CO			2	2		
DET 2D SERVICE BN	1	42				
DET 2D FSR		40				
TOTALS	66	1514	7	47		

LANDING FORCE, CARIBBEAN 1-70

7 FEBRUARY 1970

TASK GROUP 45.9 CTG: COL G. R. HUNTER UNITS EMBARKED	STRENGTH				ARMS & EQUIPMENT	LOCATION AT CRISTOBAL
	USMC		USN			
	OFF	ENL	OFF	ENL		
HQ 36TH MEU BLT 3/2 (LTCOL E. F. PIERSON JR.)					11 LVTP-5 5 M48 TANK 5 M50 ONTOS 6 105MM HOW TD 8 106MM RR 8 81MM MORTAR	SHIPPING USS GUADALCANAL (LPH-7) USS VERMILLION (LKA-107) USS SUFFOLK CTY (LST-1173) USS SPEIGEL GROVE (LSD-32)
3D BN, 2D MARINES	44	1007	4	38		
BTRY "I", 3/10	10	136	1	2		SUPPLIES CLASS I CLASS II CLASS III CLASS IV CLASS V
DET HQ BTRY, 3/10						
PLT CO "B", 2D AMTRAC BN	1	40				
PLT CO "C", 2D MT BN	1	33				
PLT CO "A", 2D AT BN	1	21				
PLT CO "A", 2D ENGR BN	1	49				
PLT HQS CO, 2D MED BN		10		17		
PLT CO "A", 2D TANK BN	1	24				
PLT CO "A", 2D SP BN	1	52		7		
PLT CO "C", 2D RECON BN	1	23		1		
DET HQBN, 2D MARDIV	1	25				
DET 2D DENTAL CO			1	1		
DET 2D SERV BN	1	40				
DET 2D FSR	1	37				
DET HQCO 2D MARINES		20				
HMM-261 (LTCOL V. M. HAZELBAKER)	43	170	1			
TOTALS	107	1687	7	61	19 CH-46D	

UNCLASSIFIED

Unclassified

MARINE CORPS COMMAND CENTER

FLEET MARINE FORCE ATLANTIC

READINESS SUMMARY

7 FEBRUARY 1970

UNCLASSIFIED

UNIT	REPORT DATE	STRENGTH		COMBAT READINESS							
		USMC	USN	RATING	REASON	P	S	E	T	RATING	DATE
2D MARINE DIVISION				C2	T	1	1	1	2	C1	700401
HEADQUARTERS BN		2107	52	C2	T	1	1	1	2	C1	700331
2D MARINES				C3	T	2	1	1	3	C2	700228
1st Bn		1216	21	C3	P	3	1	1	3	C2	700131
2nd Bn		997	19	C4	P	4	1	1	3	C3	700228
3rd Bn		1309	50	C2	P	2	1	1	1	C3	700705
6TH MARINES				C2	T	1	1	1	2	C1	700215
1st Bn		1174	37	C1		1	1	1	1	C2	700301
2nd Bn		1183	36	C1		1	1	1	1		
3rd Bn		1054	25	C2	T	1	1	1	2	C1	700215
8TH MARINES				C2	T	1	1	1	2	C1	700301
1st Bn		1334	35	C2	T	1	1	1	2	C1	700130
2nd Bn		1374	34	C1		1	1	1	1	C2	700630
3rd Bn		1189	36	C2	P	2	1	1	1	C3	700301
10TH MARINES				C1		1	1	1	1	C2	700430
1st Bn		825	11	C1		1	1	1	1	C2	700430
2nd Bn		756	11	C1		1	1	1	1	C2	700430
3rd Bn		590	5	C1		1	1	1	1	C2	700430
4th Bn		641	7	C2		1	1	2	1	C1	700131
2D SERVICE BN				C2	T	1	1	1	2	C1	700130
2D AT BN		463	7	C2	S	1	2	2	2	C1	700331
2D MT BN		306	6	C1		1	1	1	1	C2	700201
2D RECON BN		493	12	C2	T	1	1	1	2	C1	700301
2D ENGR BN		906	8	C2	T	1	1	1	2	C1	700301
2D SP BN		570	16	C2	R	1	1	2	1	C1	700331
2D MEDICAL BN		151	114	C4	S	4	1	1	4		
2D DENTAL CO			65	C1		1	1	1	1	C2	700630
FORCE TROOPS FMFLANT											
2D FSR		3110	29	C3	P	3	2	2	3	C2	700401
2D FAG		563	4	C3	R	1	2	3	2	C2	700401
2D 155 GUN BTRY		177		C3	T	2	2	2	3	C1	700401
2D 81M HOW BTRY		226		C3	R	1	1	3	1	C1	700201
2D TANK BN		794	8	C2	R	1	2	2	1	C1	700601
2D AMTRAC BN		1095	11	C3	R	1	3	3	1	C1	700501
2D FORCE RECON CO		135	2	C3	T	1	1	1	3	C2	700602
2D RADIC BN		419	2	C2	S	2	2	2	2	C1	700731
2D ANGLICO		291	11	C4	P	3	3	3	2	C3	700331
2D BRIDGE CO		158	1	C2	P	2	1	1	1	C1	700601
2D TOPO CO		90	1	C4	P	4	1	1	2	C3	700430
2D HOSPITAL CO		32	17	C4	P	4	1	1	4	C3	700228
4TH DENTAL CO		5	33	C4	P	4	1	1	1	C3	700430
8TH COMM BN		740	7	C3	S	2	3	2	2	C2	700301
8TH MT BN		473	3	C1		1	1	1	1		
8TH ENGR BN		1216	11	C3	R	1	2	3	2	C2	700531
2D MARINE AIRCRAFT WING				C3	R	3	2	3	3	C2	700531
3D LAAM BN		531	7	C3	R	3	3	3	3	C2	700303
MWSS-27				C3	P	3	1	1	3	C2	700519
VMGR-252		285	2	C3	P	3	1	1	3	C3	700601
MAG-14				C3	X	4	1	4	4	C3	700410
VMA(AW)-224		222	2	C3	X	4	1	2	4	C3	700319
VMA(AW)-121		201	1	C3	P	3	1	3	3	C2	700515
VMA(AW)-332		216	2	C3	X	3	1	2	4	C2	700416
VMCJ-2		370	2	C3	X	3	1	4	2	C2	700130
VMA-322		216	2	C3	X	3	1	3	4	C2	700416
VMFA-513		216	2	C4	P	4	1	3	4	C3	700330
MAG-26				C3	R	2	1	3	2	C2	700201
VMO-1		277		C3	P	3	2	3	2	C2	700226
HMM-362		109		C4	P	4	1	4	4	C3	700331
HMM-162		203	1	C3	R	2	2	3	1	C2	700315
HMM-261		234	3	C4	P	4	1	2	2	C3	700603
HMM-264		204		C4	P	4	1	4	1	C3	700401
HMM-365		195	1	C4	R	2	1	4	2	C3	700331
HMH-461		164	1	C4	P	4	1	4	4	C3	700510
MAG-31				C3	T	3	2	3	3	C2	700531
VMI-333		215	1	C3	T	3	1	3	3	C2	700531
VMA-331		163	1	C3	P	3	1	3	2	C2	700531
VMAF(AW)-451		215	1	C3	T	3	1	3	3	C2	700601
MAG-32				C3	P	3	2	3	3	C2	700201
VMFA-251		233	1	C4	P	4	2	4	4	C3	700602
VMFA-312		236	1	C4	T	3	2	3	4	C3	700601
VMFA-324		165	1	C3	X	4	2	3	3	C2	700501

READINESS CATEGORIES

- C-1 Fully Combat Ready
- C-2 Substantially Combat Ready
- C-3 Marginally Combat Ready
- C-4 Not Combat Ready

READINESS ABBREVIATIONS

- P Personnel Readiness
- S Supplies/Equipment on Hand
- E Equipment Readiness
- T Training Readiness

NOTE: READINESS CATEGORY INFORMATION EXTRACTED FROM STATUS OF MARINE UNIT REPORT DATES 2FEB70.
STRENGTH CATEGORY INFORMATION EXTRACTED FROM MCCC REPORT DATED 4FEB70.

Unclassified

UNCLASSIFIED

UNCLASSIFIED SUMMARY OF MAJOR US AND FWMAF OPERATIONS

OPERATION (DATE COMMENCED)	UNITS INVOLVED	LOCATION	CASUALTIES AS OF: 082400H FEB70		
			FRIENDLY		ENEMY
			KIA	WIA	KIA
GREENE RIVER (19JAN70)	1ST BDE, 5TH INF DIV (MECH): 4 USA BNS	EASTERN QUANG TRI PROVINCE	4	75	37
RANDOLPH GLEN (7DEC69)	101ST ABN DIV (AM): 9 USA BNS	QUANG TRI & THUA THIEN PROVINCES	43	239	354
VICTORY DRAGON XIX (1JAN70)	2D ROKMC BDE: 2 BNS	HOI AN AREA	1	11	9
VICTORY DRAGON XIX-21 (31JAN70)	2D ROKMC BDE: 1 BN	HOI AN AREA	1	3	1
VICTORY DRAGON 20-31 (4FEB70)	2D ROKMC BDE: 1 BN	HOI AN AREA	NONE	*1	1
FREDERICK HILL (18MAR69)	196TH INF BDE: 3 USA BNS	QUANG TIN PROVINCE	368	2,305	4,412
GENEVA PARK (18JUL69)	198TH INF BDE: 2 USA BNS	QUANG TIN & QUANG NGAI PROVINCES	125	850	1,124
NANTUCKET BEACH (20JUL69)	198TH INF BDE: 1 USA BN	CENTERED 15 KM NE OF QUANG NGAI CITY	23	206	242
IRON MOUNTAIN (18MAR69)	11TH INF BDE: 5 USA BNS	QUANG NGAI PROVINCE	287	1,632	2,460
VICTORY DRAGON XIX-1 (25JAN70) (TERM: 081000H)	2D ROKMC BDE: 1 BN	HOI AN AREA	#NONE	#8	#40

• - ADJUSTED
- FINAL CUMULATIVE CASUALTIES

~~SECRET~~

UNCLASSIFIED

Unclassified

MARINE CORPS COMMAND CENTER

SELECTED PERSONNEL AND AIRCRAFT DATA

PERSONNEL

9 FEBRUARY 1970

	STRENGTH	PERCENT USMC	PERCENT FMF	PERCENT FMFPAC
USMC TOTAL	300,982 *	100.00		
FLEET MARINE FORCES	153,729	51.08	100.00	
FMF ATLANTIC	45,696 \$	15.18	29.73	
FMF PACIFIC	108,033 #	35.90	70.27	
VIETNAM	52,974 †	17.60	34.46	49.04

SOURCE: * MONTHLY USMC PERSONNEL ALLOCATION REPORT OF 30NOV69.
 \$ MCC UNIT REPORT OF 4FEB70.
 # MCC UNIT REPORT OF 21JAN70.
 † MACV WEEKLY STRENGTH REPORT AS OF 2400, 5FEB70 AND III MAF DAILY ADMIN SITREP AS OF 2400, 6FEB70.

AIRCRAFT

5 FEBRUARY 1970

	FIXW	HELO	TOTAL	PERCENT USMC	PERCENT FMF	PERCENT FMFPAC
USMC TOTALS	1013	569	1582	100.00		
FLEET MARINE FORCES	763	543	1306	82.55	100.00	
FMF ATLANTIC	303	156	459	29.01	35.15	
FMF PACIFIC	460	387	847	53.54	64.85	
VIETNAM	156	178	334	21.11	25.57	39.43

SOURCE: MARINE CORPS COMMAND CENTER UNIT REPORT OF 31DEC69.

UNCLASSIFIED
 Unclassified

FLEET MARINE FORCE DEPLOYMENTS

9 FEBRUARY 1970

UNCLASSIFIED

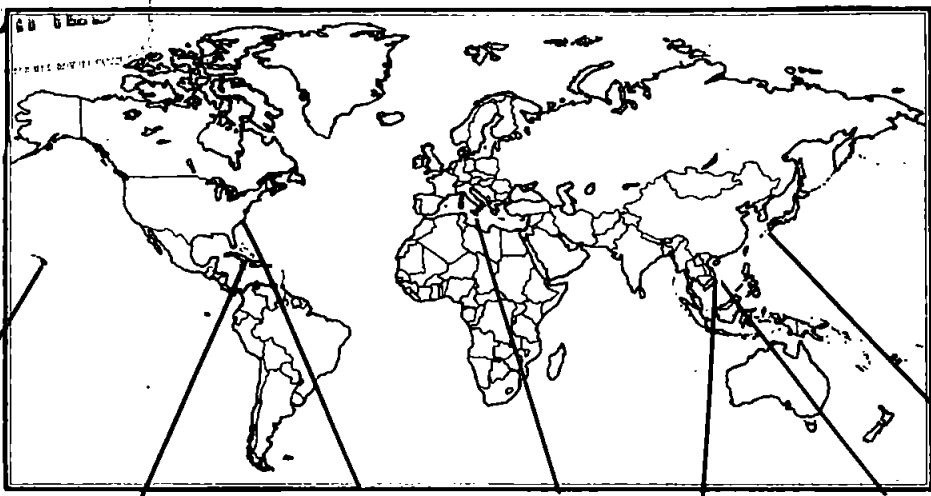

1ST MAR BRIG
HAWAII

GIMO AUGMENT
2D BN, 8TH MAR
BTRY B/1/10
PLT 2D TK BN
PLT 2D ANGLICO
DET FSR

LANFORCARIB 1-70
BLT. 3/2 & HMM-261
AT CRISTOBAL

LANFOR6THFLT 3-69
ENROUTE GREECE
ETA: 11FEB70

III MAF
RVN

SLF, 7TH FLEET
SLF BRAVO
ENR TAIWAN
ETA: 13FEB70

I MEF
OKINAWA
& JAPAN
B/1/4 & 2D PLAT/B/3D
TK BN AT FUJI FOR
TRAINING.

SLF ALFA
AT OKINAWA

DISTRIBUTION OF MAJOR FMF UNITS

	INF BNS	VMFA	VMA	VMA(AW)	VMCI	HMM	HMR	HML	VMO	VMGR
WESTPAC	18	5	2	3	1	6	2	2	2	1
RVN	(12)	(3)	(2)	(2)	(1)	(4)	(1)	(2)	(1)	
OKINAWA/JAPAN	(4)	(2)		(1)			(1)		(1)	(1)
ASSIGNED TO SLF's	(2)					(2)				
MIDPAC	1	2								
HAWAII	(1)	(2)								
AFLOAT										
EASTPAC	2	* 3	2		1	2	2	1		1
WEST COAST	(2)	(3)	(2)		(1)	(2)	(2)	(1)		(1)
AFLOAT										
ATLANTIC	8	5	2	3	1	4	2		1	1
EAST COAST	(6)	(5)	(2)	(3)	(1)	(3)	(2)		(1)	(1)
CARIBBEAN	(2)					(1)				
EUROPE	1									
MEDITERRANEAN	(1)									
GRAND TOTAL	30	15	6	6	3	12	6	3	3	3

* CATRE

UNCLASSIFIED

~~SECRET~~

UNCLASSIFIED

MARINE CORPS COMMAND CENTER

MARINE CORPS PERSONNEL IN RVN

9 FEBRUARY 1970

	OFF	ENL	TOTAL
III MAF.	3,507	48,928	52,435
DANANG	(3,007)	(42,493)	(45,500)
CHU LAI	(388)	(4,851)	(5,239)
PHU BAI	(77)	(880)	(957)
DONG HA	(35)	(704)	(739)
SU #1, 1ST ANGLICO (AT VARIOUS LOCATIONS SVN)	((21))	((191))	((212))
OTHER USMC PERSONNEL	166	373	539
MACV STAFF/MACV FIELD	(136)	(139)	(275)
NAVAVGRO/NAVY UNITS	(23)	(13)	(36)
CO "L" MARSPTBN	(2)	(73)	(75)
EMBASSY GUARDS	(5)	(148)	(153)
* USMC IN RVN CHARGED AGAINST PROGRAM VIII	3,673	49,301	52,974
U. S. NAVY, III MAF.	259	1,839	2,098

* AS REPORTED BY III MAF DAILY ADMIN SITREP # 038 AS OF 2400, 6FEB70 AND THE MACV WEEKLY STRENGTH REPORT, AS OF 2400, 5FEB70.

Unclassified

UNCLASSIFIED

~~SECRET~~

MARINE CORPS COMMAND CENTER
WESTPAC UNIT LOCATIONS

9 FEBRUARY 1970

QUANG TRI
 (QUANG TRI)

USMC	739
USN	38
USA	5,808

1ST BDE, 5TH INF DIV (MECH)
 1/77 ARMOR (OPN GREENE RIVER)
 1/61 INF (MECH) (OPN GREENE RIVER)
 1/11 INF (OPN GREENE RIVER)
 3/5 ARMD CAV SQDN (OPN GREENE RIVER)

USMC RVN RECAP

	USMC	USN
OSD PROGRAM VIII CEILING	55,510	2,233
ACTUALS CHARGED AGAINST PROGRAM VIII AS OF 6FEB70	52,974	2,098
III MAF	52,435	2,098
SU#1, 1ST ANGLICO	((214))	((14))
MACV STP/MACV FLD	(275)	
NAVAIDVGRU/NAVY UNITS	(37)	
CO "L" MARSPTRN	(75)	
EMBASSY GUARDS	(153)	

THUA THIEN
 HQ, XXIV CORPS (PHU BAI)
 HQ, 101st ABN DIV (AM)

USMC	957
USN	47
USA	26,177

1ST BDE, 101ST ABN DIV (AM)
 1/327 INF (AM) (OPN RANDOLPH GLEN)
 2/327 INF (AM) (OPN RANDOLPH GLEN)
 2/502 INF (AM) (OPN RANDOLPH GLEN)

2D BDE, 101ST ABN DIV (AM)
 1/501 INF (AM) (OPN RANDOLPH GLEN)
 2/501 INF (AM) (OPN RANDOLPH GLEN)
 1/502 INF (AM) (OPN RANDOLPH GLEN)

3D BDE, 101ST ABN DIV (AM)
 1/506 INF (AM) (OPN RANDOLPH GLEN)
 2/506 INF (AM) (OPN RANDOLPH GLEN)
 3/187 INF (AM) (OPN RANDOLPH GLEN)

1st MAW
 MAG-16
 HML-367 (UH-1E)
 HMM-262 (CH-46D)
 HMM-161 (CH-46D)

I CORPS RECAP

US MARINE CORPS	(12 BNs)	52,435
US ARMY	(25 BNs)	73,849
US NAVY		17,012
US AIR FORCE		8,194
ROKMC	(4 BNs)	6,148
RVNAF	(36 BNs)	153,895
ARVN/ABN	(36 BNs)	(74,634)
VNMC		
VNN		(2,100)
VNAF		(3,408)
VNRF		(37,403)
VNPF		(36,350)
I CORPS TOTAL	77 BNs	311,533

QUANG NAM
 HQS, III MAF
 HQS 1ST MAR DIV (DANANG)

USMC	45,500
USN	1,889
USA	1,090
ROKMC	7,145

1ST MARINES
 1/1
 2/1
 3/1

5TH MARINES
 1/5
 2/5
 3/5

7TH MARINES
 1/7
 2/7
 3/7

26TH MARINES
 1/26
 2/26
 3/26

HQ 1st MAW
 MAG-11
 VMA(AW)-242 (A-6A)
 VMA(AW)-225 (A-6A)
 VMCI-1 (RF-4/EA-6/EF-10)
 VMO-2 (AH-1G/OV-10A)

MAG-16 (-)
 HML-167 (UH-1E)
 HMH-463 (CH-53A)
 HMM-364 (CH-46D)
 HMM-263 (CH-46D)

2d ROKMC BDE
 1/2 (OPN VICTORY DRAGON 20-31)
 2/2 (OPN VICTORY DRAGON XIX-21)
 3/2 (OPN VICTORY DRAGON XIX)
 5/2 (OPN VICTORY DRAGON XIX)

SLF 7TH FLEET

	USMC	USN
BRAVO: BLT 2/9 HMM-165 ENR TAIWAN ETA: 13FEB70	1,847	60
ALFA: BLT 1/9 HMM-164 AT OKINAWA	1,868	85

FLC 1ST FSR/FLSG-B/1ST SERV BN

QUANG TIN/QUANG NGAI
 HQ 23d INF DIV (AMERICAL) (CHU LAI)

USMC	5,239
USN	124
USA	24,331

196TH LT INF BDE
 2/1 INF (OPN FREDERICK HILL)
 4/31 INF (OPN FREDERICK HILL)
 3/21 INF (OPN FREDERICK HILL)
 1/46 INF

198TH LT INF BDE
 1/6 INF (OPN GENEVA PARK)
 1/52 INF (OPN GENEVA PARK)
 5/46 INF (OPN NANTUCKET BEACH)

11TH INF BDE
 1/20 INF (OPN IRON MOUNTAIN)
 4/21 INF (OPN IRON MOUNTAIN)
 3/1 INF (OPN IRON MOUNTAIN)
 4/3 INF (OPN IRON MOUNTAIN)
 1/1 ARMD CAV SQDN (OPN IRON MOUNTAIN)

1st MAW
 MAG-12 (A-4E)
 VMA-211 (A-4E)
 VMA-311 (A-4E)

MAG-13
 VMFA-115 (F-4B)
 VMFA-314 (F-4B)
 VMFA-122 (F-4B)

MOVEMENTS
 B/1/4 & 2D Plat/B/3D Tk Bn at Fuji for training.
 Det 12THMAR and "D" Co, 3D Recon at Namazu.

OKINAWA
 HQ, I MEF
 3D MAR DIV (-) (REIN)

USMC	19,200	934
ACTUALS CHARGED AGAINST PROGRAM VIII AS OF 29JAN70	18,031	424
4TH MARINES	14,061	(349)
9TH MARINES		
MAG-36		
VMGR-152 (KC-130F)		
VMO-6 (OV-10A/UH-1E)		
HMH-462 (CH-53A)		
3D FSR	(2,906)	(50)
MCB CAMP BUTLER/NON FMF	(921)	(25)
Non-Deployable Casuals	(143)	
SVN-Originated Patients	(0)	

JAPAN

	USMC	USN
OSD PROGRAM VIII CEILING	3,600	45
ACTUALS CHARGED AGAINST PROGRAM VIII AS OF 29JAN70	3,753	34
1ST MAW (REAR)	(2,553)	(34)
MAG-15		
VMFA-232 (F-4J)		
VMFA-334 (F-4J)		
VMA(AW)-533 (A-6A)		

*Does NOT include 243 hospitalized SVN-Originated Patients.

* Includes only U. S. Navy Personnel organic to FMF Units.
 # Includes SU#1 and 1st ANGLICO at various locations throughout SVN.
 Latest Change

UNCLASSIFIED
 No. 117 (1,200)

MARINE CORPS

FEB 10 1970

REFERENCE BRANCH

Unclassified

~~SECRET~~
UNCLASSIFIED

SUMMARY OF MAJOR US AND FWMAF OPERATIONS

OPERATION (DATE COMMENCED)	UNITS INVOLVED	LOCATION	CASUALTIES AS OF: 092400H FEB70		
			FRIENDLY		ENEMY
			KIA	WIA	KIA.
GREENE RIVER (19JAN70)	1ST BDE, 5TH INF DIV (MECH); 4 USA BNS	EASTERN QUANG TRI PROVINCE	4	80	37
RANDOLPH GLEN (7DEC69)	101ST ABN DIV (AM); 9 USA BNS	QUANG TRI & THUA THIEN PROVINCES	43	239	354
VICTORY DRAGON XIX (1JAN70)	2D ROKMC BDE; 2 BNS	HOI AN AREA	1	11	9
VICTORY DRAGON XIX-21 (31JAN70)	2D ROKMC BDE; 1 BN	HOI AN AREA	1	3	1
VICTORY DRAGON 20-31 (4FEB70)	2D ROKMC BDE; 1 BN	HOI AN AREA	NONE	1	1
FREDERICK HILL (18MAR69)	196TH INF BDE; 3 USA BNS	QUANG TIN PROVINCE	368	2,306	4,426
GENEVA PARK (18JUL69)	198TH INF BDE; 2 USA BNS	QUANG TIN & QUANG NGAI PROVINCES	125	855	1,125
NANTUCKET BEACH (20JUL69)	198TH INF BDE; 1 USA BN	CENTERED 15 KM NE OF QUANG NGAI CITY	23	206	242
IRON MOUNTAIN (18MAR69)	11TH INF BDE; 5 USA BNS	QUANG NGAI PROVINCE	287	1,635	2,464

- * - ADJUSTED
- # - FINAL CUMULATIVE CASUALTIES

~~SECRET~~
UNCLASSIFIED

Unclassified

UNCLASSIFIED

MARINE CORPS COMMAND CENTER

USMC/ENEMY CASUALTIES IN RVN

9 FEBRUARY 1970

USMC BATTLE CASUALTIES

KIA/DOW	WIA(EVAC)	WIA(RTD)	MIA/PW
12,432	48,773	35,752	83/21

USMC CASUALTY FIGURES ARE PROVIDED DAILY BY HQMC CASUALTY SECTION (CODE DNA) AND REFLECT ALL CASUALTIES REPORTED AS OF 6FEB70.

USMC NON-BATTLE CASUALTIES

DEAD	INJURED	MISSING
1,499	1,818	9

FIGURES INDICATED AS INJURED ARE ONLY THOSE IN SERIOUS/CRITICAL INJURY OR DISEASE CATEGORY AND DO NOT INCLUDE THOSE OF A MINOR NATURE

USMC INFLECTED ENEMY CASUALTIES

KIA	PW	WPNS
80,286	4,119	20,630

ENEMY CASUALTIES ARE COMPILED DAILY FROM THE III MAF HISSUM AND ARE RECONCILED MONTHLY WITH THE FMFPAC SUMMARY OF USMC OPERATIONS IN RVN

TYPICAL DISPOSITION OF 100 USMC WIA *

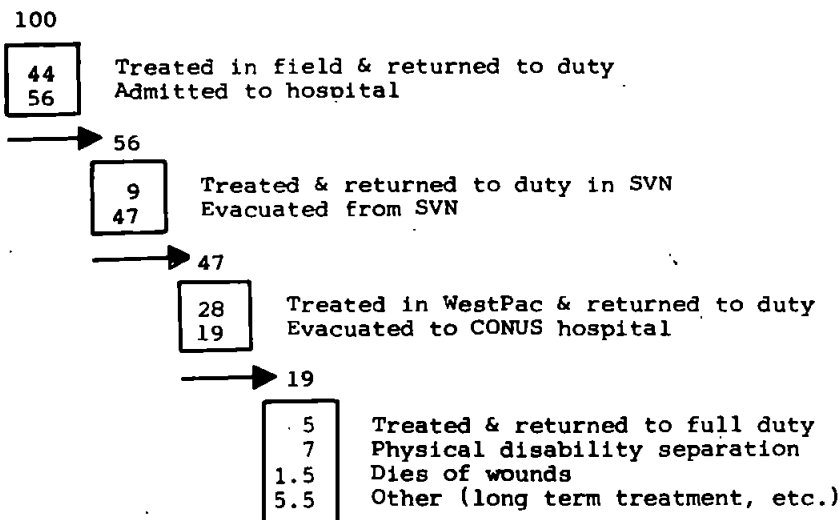

*54,081 CASUALTIES, JAN67-DEC68.

Unclassified

UNCLASSIFIED

~~CONFIDENTIAL~~

MARINE CORPS COMMAND CENTER

SPECIAL LANDING FORCE, 7TH FLEET

UNCLASSIFIED

SLF BRAVO

9 FEBRUARY 1970

TASK GROUP 79.4 CTG: COL G. G. CHAMBERS JR	STRENGTH				ARMS & EQUIPMENT	LOCATION
	USMC		USN			
	OFF	ENL	OFF	ENL		
UNITS EMBARKED						
SLF HQS DET						ENROUTE TAIWAN ETA: 13FEB70
BLT 2/9 (LTCOL J. R. VANDENELZEN) 2D BN, 9TH MARINES W/2/12 F/2/12 PLAT, CO "B", 1ST AMTRAC PLAT, CO "C", 3D ENGR BN PLAT, CO "C", 3D SP BN PLAT, CO "C", 3D MT BN PLAT, CO "C", 3D RECON BN PLAT, CO "A", 3D TK BN CLEAR PLAT, CO "B", 3D MED SQD, MP CO, 3D MARDIV DET, HQBN, 3D MARDIV DET, COMM PLT, HGCO, 9TH MAR DET, COMM SPT CO, 7TH COMM DET, 3D DENTAL CO LSU	52	1500	1	56		SHIPPING USS NEW ORLEANS (LPH-11) USS THOMASTON (LSD-28) USS VANCOUVER (LPD-2) USS WHITFIELD CTY (LST-1169)
HMM-165 (LTCOL P. H. MITCHELL)	69	226	1	2		SUPPLIES CLASS I CLASS II CLASS III CLASS IV CLASS V
TOTALS	121	1726	2	58	AIRCRAFT 18/CH-46A	

SLF ALFA

28 JANUARY 1970

TASK GROUP 79.5 CTG: COL C. W. BOYD, JR.	STRENGTH				ARMS & EQUIPMENT	LOCATION
	USMC		USN			
	OFF	ENL	OFF	ENL		
UNITS EMBARKED						
SLF HQS DET						AT OKINAWA
BLT 1/9 (LTCOL D. J. MC ADAMS) 1ST BN, 9TH MARINES MORT BTRY, 2/12 BTRY "D" (REIN), 2/12 PLAT, CO "B", 1ST AMTRAC BN PLAT, CO "C", 3D ENGR BN PLAT, CO "C", 3D SP BN PLAT, CO "A", 3D MT BN PLAT, CO "C", 3D RECON BN PLAT, CO "C", 3D TK BN CLEAR PLT, CO "B", 3D MED BN SQD, MP CO, 3D MARDIV DET, HQ BN DET, COMM PLT HQ CO, 9TH MAR DET, 3D DENTAL CO LSU DET EMU NBQ	54	1596	6	76		SHIPPING
HMM-16A (LTCOL R. D. FOWNER)	41	177	1	2		SUPPLIES CLASS I 30 DAYS CLASS II 30 DAYS CLASS III 30 DAYS CLASS IV 30 DAYS CLASS V 30 DAYS
TOTALS	95	1773	7	78	AIRCRAFT 19/CH-46A's	

Unclassified

UNCLASSIFIED

~~CONFIDENTIAL~~

MARINE CORPS COMMAND CENTER

UNCLASSIFIED

MILITARY FORCES IN RVN *

9 FEBRUARY 1970

RVN ARMED FORCES (RVNAF)

ARMY (ARVN)	416,278
NAVY (VNN)	30,143
AIR FORCE (VNAF)	36,469
MARINE CORPS (VNMC)	11,528
REGIONAL FORCES (RF)	260,455
POPULAR FORCES (PF)	214,383
TOTAL RVNAF	969,256

UNITED STATES FORCES

ARMY	332,158
NAVY	29,526
AIR FORCE	57,087
MARINE CORPS	52,974
COAST GUARD	375
TOTAL U.S.	472,120

FREE WORLD MILITARY ASSISTANCE FORCES (FWMAF)

REPUBLIC OF KOREA	48,893
AUSTRALIA	7,692
PHILIPPINES	142
THAILAND	11,566
NEW ZEALAND	556
REPUBLIC OF CHINA	28
SPAIN	10
TOTAL FWMAF	68,887

TOTAL FORCES IN RVN 1,510,263

SOURCE: RVNAF MACV MONTHLY GIVEN FORCES STRENGTH DATA REPORT.

ALL OTHER, MACV WEEKLY STRENGTH REPORT AS OF 2400, 5FEB70. USMC STRENGTH: MACV WK STRENGTH REPORT AND III MAF DAILY ADMIN SITREP AS OF 2400, 6FEB70.

UNCLASSIFIED

Unclassified

~~CONFIDENTIAL~~

MARINE CORPS COMMAND CENTER

SELECTED PERSONNEL AND AIRCRAFT DATA

UNCLASSIFIED

PERSONNEL

10 FEBRUARY 1970

	STRENGTH	PERCENT USMC	PERCENT FMF	PERCENT FMFPAC
USMC TOTAL	300,982 *	100.00		
FLEET MARINE FORCES	153,729	51.08	100.00	
FMF ATLANTIC	45,696 \$	15.18	29.73	
FMF PACIFIC	108,033 #	35.90	70.27	
VIETNAM	52,980 †	17.60	34.46	49.04

SOURCE: * MONTHLY USMC PERSONNEL ALLOCATION REPORT OF 30NOV69.
 \$ MCCC UNIT REPORT OF 4FEB70.
 # MCCC UNIT REPORT OF 21JAN70.
 † MACV WEEKLY STRENGTH REPORT AS OF 2400, 5FEB70 AS ADJUSTED BY THE MACV DAILY RPT OF ARR/DEP AS OF 2400, 8FEB70.

AIRCRAFT

5 FEBRUARY 1970

	FDXW	HELO	TOTAL	PERCENT USMC	PERCENT FMF	PERCENT FMFPAC
USMC TOTALS	1013	569	1582	100.00		
FLEET MARINE FORCES	763	543	1306	82.55	100.00	
FMF ATLANTIC	303	156	459	29.01	35.15	
FMF PACIFIC	460	387	847	53.54	64.85	
VIETNAM	156	178	334	21.11	25.57	39.43

SOURCE: MARINE CORPS COMMAND CENTER UNIT REPORT OF 31DEC69.

UNCLASSIFIED

Unclassified

~~CONFIDENTIAL~~

FLEET MARINE FORCE DEPLOYMENTS

10 FEBRUARY 1970

UNCLASSIFIED

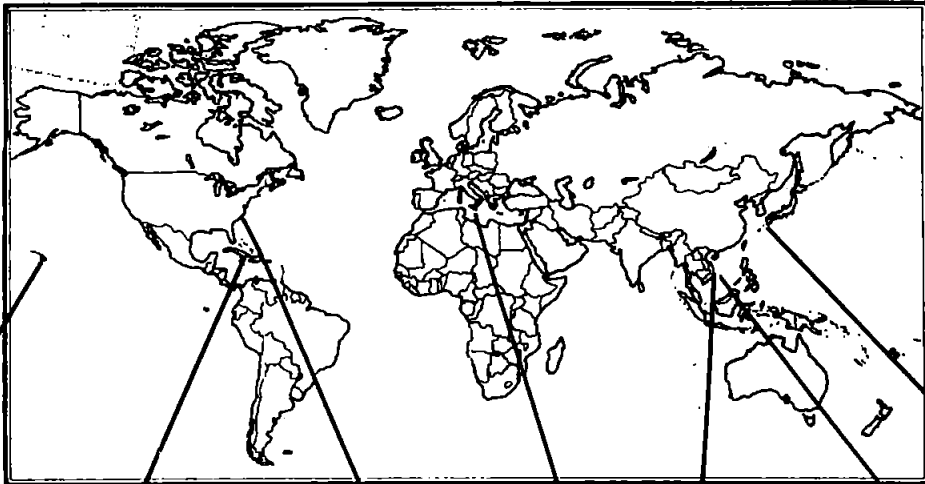

1ST MAR BRIG
HAWAII

I MEF
OKINAWA
& JAPAN

GIMO AUGMENT
DET HQBN 10TH MAR
DET 1/10
DET 2/10
DET 3/10
DET 4/10
DET 2nd FAG
DET 1, HMM 264
ENR VIEQUES
FOR FIREX

LANFORCARIB 1-70
BLT 3/2 & HMM-261
AT CRISTOBAL

LANFOR6THFLT 3-69
AT NAVPLION
GREECE

III MAF
RVN

SLF, 7TH FLEET
SLF BRAVO
ENR TAIWAN
ETA, 13FEB70

SLF ALFA
AT OKINAWA

DISTRIBUTION OF MAJOR FMF UNITS

	INF BNS	VMFA	VMA	VMA(AW)	VMCJ	RMN	RMH	HML	VMO	VMGR
WESTPAC	18	5	2	3	1	6	2	2	2	1
RVN	(12)	(3)	(2)	(2)	(1)	(4)	(1)	(2)	(1)	
OKINAWA/JAPAN	(4)	(2)		(1)			(1)		(1)	(1)
ASSIGNED TO SLF's	(2)					(2)				
MIDPAC	1	2								
HAWAII	(1)	(2)								
AFLOAT										
EASTPAC	2	* 3	2		1	2	2	1		1
WEST COAST	(2)	(3)	(2)		(1)	(2)	(2)	(1)		(1)
AFLOAT										
ATLANTIC	8	5	2	3	1	4	2		1	1
EAST COAST	(6)	(5)	(2)	(3)	(1)	(3)	(2)		(1)	(1)
CARIBBEAN	(2)					(1)				
EUROPE	1									
MEDITERRANEAN	(1)									
GRAND TOTAL	30	15	6	6	3	12	6	3	3	3

* CAFRE

UNCLASSIFIED

MARINE CORPS COMMAND CENTER

SELECTED UNIT COMMANDERS AND STAFF OFFICERS

10 FEBRUARY 1970

UNCLASSIFIED

HEADQUARTERS FLEET MARINE FORCE PACIFIC

COMMANDING GENERAL	LTGEN H. W. BUSE, JR.
DEPUTY COMMANDER	MGEN P. J. FONTANA
CHIEF OF STAFF	BGEN L. H. WILSON
ACOS, G-1	COL F. S. WOOD
ACOS, G-2	COL J. F. MITCHELL
ACOS, G-3	COL R. M. HALL
ACOS, G-4	COL J. B. SOPER
ACOS, G-5	LTCOL E. L. HICKAM

5TH MARINE EXPEDITIONARY BRIGADE

COMMANDING GENERAL	BGEN R. T. DWYER, JR.
ADC	
CHIEF OF STAFF	COL M. W. SCHMIDT
ACOS, G-1	COL E. R. DAZE
ACOS, G-2	MAJOR J. D. LITTLE
ACOS, G-3	COL J. P. KELLY
ACOS, G-4	COL G. R. STURDIVAN
HQ BN	LTCOL J. F. HEL
H&SCO	MAJ J. A. LINNEMANN
<u>3RD MARINES</u>	
COMMANDING OFFICER	COL W. A. BUTCHER
2ND BATTALION	LTCOL E. Z. GRABOWSKI
3RD BATTALION	LTCOL J. G. COLLIER
1STBN, 12THMAR	LTCOL J. F. HELSEL
M BTRY, 4THBN, 12THMAR	
CoA, 3D AT BN	CAPT C. W. FATTIG
CoA, 3D RECON BN	CAPT R. E. FIELDS, JR.
CoB, 3D ENGR BN	CAPT A. A. LOPEZ
CoB, 3D MT BN	CAPT M. A. SELBY
Co B, 3D SP BN	MAJ E. V. SULLIVAN, JR.
Co D, 3D TANK BN	CAPT W. J. BIBELLO
DET, 3D SERVICE BN	COL G. K. REID
COMM SPT CO, 9TH COMM BN	MAJ W. B. LUDWICK
Co B, 11TH ENGR BN	CAPT H. L. CAMPBELL
Co B, 9TH MT BN	CAPT C. D. GARRETT
Co A, 1ST AMTRAC BN	MAJ R. G. JONES
1ST SEARCHLIGHT BTRY	CAPT K. C. KALBFLEISCH
9TH SEP BULK FUEL CO	MAJ M. E. MC PHERSON
3D BRIDGE CO	CAPT J. P. MEREDITH
1ST ARMD AMPHIB CO	MAJ R. D. DASCH
1ST CIVIL AFFAIRS GROUP	COL R. M. TAYLOR
3D HOSP CO	LT E. J. CARLISLE (USN)
Co C, 3D MED BN	LCDR C. H. MCALLISTER

1ST MARINE BRIGADE

COMMANDING OFFICER	COL B. G. CASS
S-1	LTCOL W. H. WAHFELD
S-2	CWO P. B. MURPHY
S-3	LTCOL J. R. W. COCHRAN
S-4	LTCOL E. L. CONROY
H&SCO	MAJ J. G. HANRAHAN
1ST BN, 3D MARINES	LTCOL D. J. HUNTER
<u>MAG-24</u>	
COMMANDING OFFICER	COL K. C. PALMER
H&MS-24	LTCOL W. H. HEINTZ
M&BS-24	LTCOL A. B. COLBERT
M&CS-2	LTCOL R. D. MILLER
VMFA-212	LTCOL H. H. ZIEGLER
VMFA-235	LTCOL L. A. MADERA
MATCU-70	MAJOR H. B. VERGARA
SU#2, 1ST RAD BN	MAJOR L. K. RUSSELL

FORCE TROOPS FMFAC

COMMANDING GENERAL	BGEN C. W. HOFFMAN
ASSISTANT COMMANDER	COL A. B. CLARK
CHIEF OF STAFF	COL L. N. UTTER
ACOS, G-1	LTCOL D. K. GRAY
ACOS, G-2	1STLT R. COOK
ACOS, G-3	LTCOL W. R. MILLER, JR.
ACOS, G-4	LTCOL M. E. FARMER
<u>3RD FORCE SERVICE REGT</u>	
COMMANDING OFFICER	COL J. R. JONES
H&S BATTALION	LTCOL J. B. HARRIS
SUPPLY BATTALION	LTCOL R. E. ROURKE
MAINT BATTALION	LTCOL L. I. FEIN
<u>5TH FORCE SERVICE REGT</u>	
COMMANDING OFFICER	COL K. W. HENRY
H&S BATTALION	MAJOR J. A. SCHEARMAN, JR.
SUPPLY BATTALION	LTCOL R. O. BARNES
MAINT BATTALION	LTCOL J. M. HERMES
13TH MT BATTALION	MAJOR T. M. COLLINS
9TH COMM BATTALION	MAJ C. E. TEAGUE

UNCLASSIFIED

Unclassified

UNCLASSIFIED

SELECTED UNIT COMMANDERS AND STAFF OFFICERS

10 FEBRUARY 1970

HEADQUARTERS III MARINE AMPHIBIOUS FORCE

COMMANDING GENERAL	LTGEN H. NICKERSON, JR.
DEPUTY COMMANDER	MGEN G. S. BOWMAN, JR.
CHIEF OF STAFF	BGEN L. J. DULACKI
DEPUTY CHIEF OF STAFF	COL S. A. DRESSIN
ACOS, G-1	COL R. L. PARNELL, JR.
ACOS, G-2	COL E. W. DEZALO
ACOS, G-3	BGEN T. H. MILLER, JR.
ACOS, G-4	COL W. F. SIMLIK
ACOS, G-5	COL C. J. PEABODY
ACOS, G-6	LTCOL R. S. BARRY
ACOS, COMPT	LTCOL J. M. VOSMIK
DEP C/S SPECIAL PROJECTS	COL A. T. WOOD

DEP C/S XXIV CTZ COL M. M. COOK

ACOS, CAP	COL T. E. METZGER
COMMANDING OFFICER, 1ST CAG	LTCOL D. F. SEILER
COMMANDING OFFICER, 2ND CAG	LTCOL D. R. CHRISTENSEN
COMMANDING OFFICER, 3RD CAG	LTCOL C. M. DANIELS
COMMANDING OFFICER, 4TH CAG	LTCOL J. J. KEENAN
1ST RADIO BATTALION	LTCOL D. M. HOPKINS

1ST MARINE DIVISION

COMMANDING GENERAL	MGEN E. B. WHEELER
ADC	BGEN W. F. DOEHLER
ADC	BGEN C. S. ROBERTSON
CHIEF OF STAFF	COL C. E. WALKER
ACOS, G-1	COL R. E. BARDE
ACOS, G-2	COL E. A. WILCOX
ACOS, G-3	COL F. H. WALDROP
ACOS, G-4	COL N. A. CANZONA
ACOS, G-5	COL L. S. HULLIER
ACOS, COMPT	LTCOL N. M. LASLAVIC, JR.
CEO	COL C. G. DAHL

1ST MARINES
 COMMANDING OFFICER COL H. L. WILKERSON
 1ST BATTALION LTCOL G. S. DELCUZE
 2ND BATTALION LTCOL W. V. H. WHITE
 3RD BATTALION LTCOL F. M. BOYD

5TH MARINES
 COMMANDING OFFICER COL N. L. BECK
 1ST BATTALION LTCOL J. K. GRIFFIS, JR.
 2ND BATTALION LTCOL F. LEDER
 3RD BATTALION LTCOL J. S. GESTSON

7TH MARINES
 COMMANDING OFFICER COL G. S. CODISPOTI
 1ST MARINES LTCOL C. G. COOPER
 2ND MARINES LTCOL A. E. FOLSOM
 3RD MARINES LTCOL R. G. KUMMEROW

26TH MARINES
 COMMANDING OFFICER COL J. E. HARRELL
 1ST BATTALION LTCOL J. C. GOODIN
 2ND BATTALION LTCOL P. L. HUMPHREY
 3RD BATTALION LTCOL J. J. UNTERKOFER

11TH MARINES
 COMMANDING OFFICER COL D. D. EZELL
 1ST BATTALION LTCOL J. D. SHOUP
 2ND BATTALION LTCOL V. WEAVER
 3RD BATTALION LTCOL K. N. MUELLER
 4TH BATTALION LTCOL J. F. BURKE, JR.

1ST BN, 13TH MAR LTCOL D. H. STRAIN

HQS BATTALION COL W. C. PATTON

1ST ENGR BATTALION	LTCOL N. F. GLOWICKI
1ST RECON BATTALION	LTCOL W. C. DRUMWRIGHT
1ST MT BATTALION	LTCOL M. S. SHIMANOFF
1ST SP BATTALION	LTCOL R. F. ARMSTRONG
1ST MED BATTALION	CAPT(MC) J. W. LEA
1ST TK BATTALION	MAJOR J. I. LOUDER
3RD AMTRAC BATTALION	LTCOL D. G. MEHARGUE
7TH ENGR BATTALION	LTCOL W. G. BATES
9TH ENGR BATTALION	LTCOL E. K. MAXWELL
11TH MT BATTALION	LTCOL W. R. KEPHART

FORCE LOGISTICS COMMAND

COMMANDING GENERAL	BGEN M. J. PADALINO
CHIEF OF STAFF	COL J. L. TOBIN
ACOS, G-1	LTCOL J. E. REDELFS
ACOS, G-2	LTCOL R. L. SOLZE
ACOS, G-3	LTCOL W. W. STORM, III
ACOS, G-4	LTCOL M. H. IVINS
ACOS, G-5	MAJOR R. E. JOHNSON
ACOS, COMPT	LTCOL F. R. WARREN
CEO	MAJOR R. D. HAGAN

1ST FORCE SERVICE REGT
 H&S BATTALION LTCOL L. R. WEBB
 SUPPLY BATTALION COL R. W. CALVERT
 MAINT BATTALION LTCOL E. C. MORRIS

FLSG-B/1ST SERV BN COL D. E. MORIN
 5TH COMM BATTALION (REIN) LTCOL D. E. SHATZER
 7TH MT BATTALION LTCOL R. L. PRATHER
 1ST MP BATTALION LTCOL S. D. THOMAIDIS
 3RD MP BATTALION LTCOL C. FIMIAN

UNCLASSIFIED

UNCLASSIFIED

MARINE CORPS COMMAND CENTER

SELECTED UNIT COMMANDERS AND STAFF OFFICERS

10 FEBRUARY 1970

1ST MARINE AIRCRAFT WING

COMMANDING GENERAL
 AWC
 CHIEF OF STAFF
 ACOS, G-1
 ACOS, G-2
 ACOS, G-3
 ACOS, G-4
 ACOS, COMPT
 CEO

MGEN W. G. THRASH
 BGEN R. H. SPANJER
 COL R. W. TELLER
 COL G. S. STEWART
 COL J. R. WEAVER
 COL R. L. LAMAR
 COL W. C. MCGRAW
 COL E. J. ARTNAK
 LTCOL T. KALUS

MWHG-1
 COMMANDING OFFICER
 H&HS-1
 MWFS-1
 MWCS-1

COL L. J. STIEN
 MAJ W. S. HUMBERT
 LTCOL N. F. SCHNIPPEL, JR.
 MAJOR A. B. RAY

MWSG-17
 COMMANDING OFFICER
 H&MS-17
 WERS-17

COL R. A. SAVAGE
 LTCOL D. SERRIN
 MAJOR W. F. FARLEY

MACG-18
 COMMANDING OFFICER
 H&HS-18
 MACS-4

COL S. G. DUNWIDDIE, JR.
 LTCOL H. E. HOPPEMEYER, JR.
 LTCOL R. W. MOLYNEUX, JR.

MASS-3
 LTCOL J. H. DUBOTS

MAG-11
 COMMANDING OFFICER
 H&MS-11
 MABS-11
 VMCJ-1
 VMA(AW)-225
 VMA(AW)-242
 VMO-2

COL N. E. HEFFERNAN
 LTCOL R. F. HEBERT
 LTCOL P. A. MANNING
 LTCOL B. W. FARLEY
 LTCOL J. J. METZKO
 LTCOL S. P. LEWIS
 LTCOL J. M. MORIARTY

MAG-12
 COMMANDING OFFICER
 H&MS-12
 MABS-12
 VMA-311
 VMA-211
 VMA-223

COL J. R. WEAVER
 LTCOL J. J. WENT
 LTCOL G. J. ERTLMEIR
 MAJOR A. R. HICKLE
 LTCOL L. GASPERINE, JR.
 LTCOL J. W. IAZZO

MAG-13
 COMMANDING OFFICER
 H&MS-13
 MABS-13
 VMFA-115
 VMFA-314
 VMFA-122

LTCOL T. E. MURPHREE
 MAJOR F. J. HORAK, JR.
 MAJOR R. D. REVIE
 LTCOL D. P. BOWEN
 LTCOL T. J. KELLY
 LTCOL R. E. HOWARD, JR.

MAG-16
 COMMANDING OFFICER
 H&MS-16
 MABS-16

COL J. P. BRUCE
 MAJOR M. T. HORNSBY
 LTCOL P. C. SCAGLIONE

HMH-463
 HML-167
 HMM-364
 HMM-263

LTCOL C. A. BLOCK
 LTCOL J. E. WEBER
 LTCOL C. R. DUNBAUGH
 LTCOL W. R. LEDBETTER

HMM-161
 HMM-262
 HML-367

MAJOR B. H. MANN
 LTCOL R. A. BANCROFT
 LTCOL W. G. CRETNEY

3D MARINE AIRCRAFT WING

COMMANDING GENERAL
 AWC
 CHIEF OF STAFF
 ACOS, G-1
 ACOS, G-2
 ACOS, G-3
 ACOS, G-4

MGEN R. G. OWENS, JR.
 BGEN J. A. FEELEY, JR.
 COL H. N. MEHAFFEY
 LTCOL L. A. GULLING
 COL R. J. GRAHAM
 COL D. WILKER

MWHG-3
 COMMANDING OFFICER
 H&MS-3
 MWFS-3
 MWCS-3

COL G. L. LILlich
 LTCOL J. B. LAVELLE
 MAJOR J. S. LOOP
 MAJOR D. B. NEWTON

MHTG-30
 COMMANDING OFFICER
 H&MS-30
 HMHT-301
 HMHT-302

COL A. F. GAROTTO
 LTCOL R. W. CREIGHTON
 LTCOL L. W. JARMAN
 LTCOL K. D. VANEK

MAG-33
 COMMANDING OFFICER
 H&MS-33
 MABS-33
 VMCJ-3
 VMA-214
 VMFA-323 (CAIRE)
 VMFAT-101
 VMFA-531
 VMFA-542
 VMA-223

COL F. N. PIPPIN
 LTCOL R. H. HUTCHINSON
 MAJOR J. E. KEHRLE
 LTCOL R. E. PERCIVAL
 LTCOL W. R. SMITH
 MAJ K. A. ZIMMERMAN II
 LTCOL R. W. KRON
 LTCOL J. L. THATCHER
 LTCOL K. A. SMITH
 LTCOL J. W. IAZZO

MWSG-37
 COMMANDING OFFICER
 H&MS-37
 WERS-37
 VMGR-352

COL F. E. WILSON
 LTCOL D. L. RICE
 LTCOL R. W. DUPIHNEY
 LTCOL H. D. STOTT

MACG-38
 COMMANDING OFFICER
 H&MS-38
 SU#1, H&MS-38
 MACS-1
 MACS-3
 MACS-7
 1STLAAM BN
 2NDLAAM BN

LTCOL T. I. GUNNING
 MAJOR F. L. HARDING
 MAJOR D. V. STOWELL
 MAJ C. F. KELLENBARGER
 LTCOL T. M. KAUFFMAN
 LTCOL D. E. ROBERTS
 MAJOR E. L. HOUSE, JR.
 MAJOR H. J. BALDWIN, JR.

MAG-56
 COMMANDING OFFICER
 H&MS-56
 MABS-56
 HMH-363
 HML-267
 HMH-361
 HMM-163
 HMM-265

COL M. D. PORTER
 LTCOL G. H. BUCKNER II
 LTCOL F. L. YOHE
 LTCOL R. P. BRAY
 LTCOL J. M. BLANC
 MAJ R. A. GOVANI
 LTCOL F. A. MATHEWS
 LTCOL R. G. COUNTRY

MCCRTG-10
 COMMANDING OFFICER
 H&MS-10
 VMAT-102
 VMT-103

COL G. FINK
 MAJ I. L. IRIEFER
 LTCOL B. A. SCHAFER
 LTCOL M. T. GARRISON

UNCLASSIFIED

~~SECRET~~

UNCLASSIFIED

MARINE CORPS COMMAND CENTER

MARINE CORPS PERSONNEL IN RVN

10 FEBRUARY 1970

	OFF	ENL	TOTAL
* III MAF.	3,509	49,160	52,669
DANANG	(3,009)	(42,725)	(45,734)
CHU LAI	(388)	(4,851)	(5,239)
PHU BAI	(77)	(880)	(957)
DONG HA	(35)	(704)	(739)
SU #1, 1ST ANGLICO (AT VARIOUS LOCATIONS SVN)	((21))	((191))	((212))
OTHER USMC PERSONNEL	159	152	311
MACV STAFF/MACV FIELD	(136)	(139)	(275)
NAVAVGRU/NAVY UNITS	(23)	(13)	(36)
USMC IN RVN CHARGED AGAINST PROGRAM VIII	3,668	49,312	52,980
U. S. NAVY, III MAF.	259	1,839	2,098

* AS REPORTED BY III MAF DAILY ADMIN SITREP # 038 AS OF 2400, 6FEB70 AND THE MACV WEEKLY STRENGTH REPORT, AS OF 2400, 5FEB70. AS ADJUSTED BY MACV DAILY RPT OF ARR/DEP AS OF 2400, 8FEB70

Unclassified

UNCLASSIFIED

~~SECRET~~

WESTPAC UNIT LOCATIONS

10 FEBRUARY 1970

QUANG TRI

(QUANG TRI)

USMC 739
USN 38 *
USA 5,808

1ST BDE, 5TH INF DIV (MECH)
1/77 ARMOR (OPN GREENE RIVER)
1/61 INF (MECH) (OPN GREENE RIVER)
1/11 INF (OPN GREENE RIVER)
3/5 ARMD CAV SQDN (OPN GREENE RIVER)

THUA THIEN

HQ, XXIV CORPS (PHU BAI)

HQ, 101st ABN DIV (AM)

1ST BDE, 101ST ABN DIV (AM)
1/327 INF (AM) (OPN RANDOLPH GLEN)
2/327 INF (AM) (OPN RANDOLPH GLEN)
2/502 INF (AM) (OPN RANDOLPH GLEN)

2D BDE, 101ST ABN DIV (AM)
1/501 INF (AM) (OPN RANDOLPH GLEN)
2/501 INF (AM) (OPN RANDOLPH GLEN)
1/502 INF (AM) (OPN RANDOLPH GLEN)

3D BDE, 101ST ABN DIV (AM)
1/506 INF (AM) (OPN RANDOLPH GLEN)
2/506 INF (AM) (OPN RANDOLPH GLEN)
3/187 INF (AM) (OPN RANDOLPH GLEN)

1st MAW

MAG-16
HML-367 (UH-1E)
HMM-262 (CH-46D)
HMM-161 (CH-46D)

USMC 957
USN 47 *
USA 26,177

QUANG NAM

HQS, III MAF

HQS 1ST MAR DIV (DANANG)

1ST MARINES
1/1
2/1
3/1

5TH MARINES
1/5
2/5
3/5

7TH MARINES
1/7
2/7
3/7

26TH MARINES
1/26
2/26
3/26

HQ 1st MAW
MAG-11

VMA(AW)-242 (A-6A)
VMA(AW)-225 (A-6A)
VMCJ-1 (RF-4/EA-6/EF-10)
VMO-2 (AH-1G/OV-10A)

MAG-16 (-)
HML-167 (UH-1E)
HMM-463 (CH-53A)
HMM-364 (CH-46D)
HMM-263 (CH-46D)

USMC 45,734 *
USN 1,889 *
USA 1,090
ROKMC 7,145

2d ROKMC BDE

1/2 (OPN VICTORY DRAGON 20-31)
2/2 (OPN VICTORY DRAGON XIX-21)
3/2 (OPN VICTORY DRAGON XIX)
5/2 (OPN VICTORY DRAGON XIX)

FLC 1ST FSR/FLSG-B/1ST SERV BN

QUANG TIN/QUANG NGAI

HQ 23d INF DIV (AMERICAN) (CHU LAI)

196TH LT INF BDE
2/1 INF (OPN FREDERICK HILL)
4/31 INF (OPN FREDERICK HILL)
3/21 INF (OPN FREDERICK HILL)
1/46 INF

198TH LT INF BDE
1/6 INF (OPN GENEVA PARK)
1/52 INF (OPN GENEVA PARK)
5/46 INF (OPN NANTUCKET BEACH)

11TH INF BDE
1/20 INF (OPN IRON MOUNTAIN)
4/21 INF (OPN IRON MOUNTAIN)
3/1 INF (OPN IRON MOUNTAIN)
4/3 INF (OPN IRON MOUNTAIN)
1/1 ARMD CAV SQDN (OPN IRON MOUNTAIN)

1st MAW

MAG-12 (A-4E)
VMA-211 (A-4E)
VMA-311 (A-4E)

MAG-13
VMFA-115 (F-4B)
VMFA-314 (F-4B)
VMFA-122 (F-4B)

USMC 5,239
USN 124 *
USA 24,331

OKINAWA

HQ, I MEF
3D MAR DIV (-) (REIN)

OSD PROGRAM VIII CEILING 19,200 934

ACTUALS CHARGED AGAINST
PROGRAM VIII AS OF 29JAN70. 18,031 424

4TH MARINES 9TH MARINES
1/4 3/9
2/4
3/4

MAG-36 (14,061 (349)
VMGR-152 (KC-130F)
VMO-6 (OV-10A/UH-1E)
HML-462 (CH-53A)

3D FSR (2,906) (50)
MCB CAMP BUTLER/NON FMP (921) (25)
Non-Deployable Casuals (143)
SVN-Originated Patients (0)

USMC 19,200
USN 934
ACTUALS CHARGED AGAINST
PROGRAM VIII AS OF 29JAN70. 18,031 424
(14,061 (349)
(2,906) (50)
(921) (25)
(143)
(0)

USMC RVN RECAP

OSD PROGRAM VIII CEILING 55,510 2,233
ACTUALS CHARGED AGAINST PROGRAM VIII AS OF 7FEB69. 52,980* 2,098
III MAF 52,669* 2,098
SU#1, 1ST ANGLICO ((214)) ((14))
MACV STP/MACV FLD (275)
NAVAW/GRU/NAVY UNITS (36)*
CO "L" MARSPTBN (75)
EMBASSY GUARDS (153)

I CORPS RECAP

US MARINE CORPS . . . (12 BNs) 52,669 *
US ARMY (25 BNs) 73,849
US NAVY 17,012
US AIR FORCE 8,194
ROKMC (4 BNs) 6,148
RVNAF (36 BNs) 153,895
ARVN/ABN (36 BNs) (74,634)
VNMC
VNN (2,100)
VNAF (3,408)
VNRFC (37,403)
VNPFC (36,350)

I CORPS TOTAL 77 BNs 311,767 *

SLF 7TH FLEET

BRAVO: BLT 2/9 1,847 60
HMM-165
ENR TAIWAN
ETA: 13FEB70

ALFA: BLT 1/9 1,868 85
HMM-164
AT OKINAWA

MOVEMENTS

Det 12TFMAR and "D" Co, 3D Recon
at Fuji for training.

JAPAN

OSD PROGRAM VIII CEILING 3,600 45
ACTUALS CHARGED AGAINST
PROGRAM VIII AS OF 29JAN70. 3,753 34

1ST MAW (REAR)

MAG-15 (2,553) (34)
VMFA-232 (F-4J)
VMFA-334 (F-4J)
VMA(AW)-533 (A-6A)

*Does NOT include 243 hospitalized
SVN-Originated Patients.

Non FMP (1,200)

* Includes only U. S. Navy Personnel organic to FMP Units.
Includes SU#1 and 1st ANGLICO at various locations
throughout SVN.
• Latest Change

Unclassified

UNCLASSIFIED

MARINE CORPS
FEB 10 1970
REFERENCE BRANCH

Unclassified

UNCLASSIFIED

SUMMARY OF MAJOR US AND FWMAF OPERATIONS

OPERATION (DATE COMMENCED)	UNITS INVOLVED	LOCATION	CASUALTIES AS OF: 102400H FEB70		
			FRIENDLY		ENEMY
			KIA	WIA	KIA
GREENE RIVER (19JAN70)	1ST BDE, 5TH INF DIV (MECH): 4 USA BNS	EASTERN QUANG TRI PROVINCE	4	87	42
RANDOLPH GLEN (7DEC69)	101ST ABN DIV (AM): 9 USA BNS	QUANG TRI & THUA THIEN PROVINCES	43	239	357
VICTORY DRAGON XIX (1JAN70)	2D ROKMC BDE: 2 BNS	HOI AN AREA	1	11	9
VICTORY DRAGON XIX-21 (31JAN70)	2D ROKMC BDE: 1 BN	HOI AN AREA	1	3	1
VICTORY DRAGON 20-31 (4FEB70)	2D ROKMC BDE: 1 BN	HOI AN AREA	NONE	1	1
FREDERICK HILL (18MAR69)	196TH INF BDE: 3 USA BNS	QUANG TIN PROVINCE	369	2,316	4,439
GENEVA PARK (18JUL69)	198TH INF BDE: 2 USA BNS	QUANG TIN & QUANG NGAI PROVINCES	125	855	1,125
NANTUCKET BEACH (20JUL69)	198TH INF BDE: 1 USA BN	CENTERED 15 KM NE OF QUANG NGAI CITY	23	206	244
IRON MOUNTAIN (18MAR69)	11TH INF BDE: 5 USA BNS	QUANG NGAI PROVINCE	287	1,639	2,465

• - ADJUSTED
- FINAL CUMULATIVE CASUALTIES

UNCLASSIFIED
Unclassified

10 FEBRUARY 1970

**NUMBER OF CASUALTIES INCURRED BY U. S. MILITARY PERSONNEL
IN CONNECTION WITH THE CONFLICT IN VIET-NAM**

Cumulative from January 1, 1961 through January 31, 1970

	Army	Navy **	Marine Corps	Air Force	Total
A. CASUALTIES RESULTING FROM ACTIONS BY HOSTILE FORCES					
1. Killed	21,550	974	11,053	401	33,978
2. Wounded or Injured					
a. Died of wounds	2,931	129	1,349	37	4,446
b. Nonfatal wounds					
Hospital care required	81,316	3,625	48,676	662	134,279
Hospital care not required	88,630	5,253	35,707	2,079	131,669
3. Missing					
a. Died while missing	1,417	176	5	332	1,930
b. Returned to control	56	7	6	25	94
c. Current missing	189	112	83	547	931
4. Captured or Interned					
a. Died while captured or interned	13	-	3	1	17
b. Returned to control	37	3	4	6	50
c. Current captured or interned	53	142	21	212	428
5. Deaths					
a. From aircraft accidents/incidents					
Fixed Wing	73	154	132	603	962
Helicopter	1,468	54	370	41	1,933
b. From ground action	<u>24,370</u>	<u>1,071</u>	<u>11,908</u>	<u>127</u>	<u>37,476</u>
TOTAL DEATHS <u>a/</u>	25,911	1,279	12,410	771	40,371
B. CASUALTIES NOT THE RESULT OF ACTIONS BY HOSTILE FORCES					
6. Current Missing	116	-	8	-	124
7. Deaths					
a. From aircraft accidents/incidents					
Fixed Wing	218	121	44	225	608
Helicopter	1,227	26	216	8	1,477
b. From other causes	<u>3,295</u>	<u>538</u>	<u>1,237</u>	<u>209</u>	<u>5,279</u>
TOTAL DEATHS	4,740	685	1,497	442	7,364

a/ Sum of lines 1, 2a, 3a and 4a.

**Navy figures include a small number of Coast Guard casualties.

Directorate for Information Operations
Office of the Secretary of Defense
February 4, 1970

Unclassified

UNCLASSIFIED

MARINE CORPS COMMAND CENTER

USMC/ENEMY CASUALTIES IN RVN

10 FEBRUARY 1970

USMC BATTLE CASUALTIES

KIA/DOW	WIA(EVAC)	WIA(RTD)	MIA/PW
12,445	48,798	35,777	83/21

USMC CASUALTY FIGURES ARE PROVIDED DAILY BY
HOMC CASUALTY SECTION (CODE DNA) AND REFLECT
ALL CASUALTIES REPORTED AS OF 9FEB70.

USMC NON-BATTLE CASUALTIES

DEAD	INJURED	MISSING
1,503	1,821	9

FIGURES INDICATED AS INJURED ARE ONLY THOSE
IN SERIOUS/CRITICAL INJURY OR DISEASE CATEGORY
AND DO NOT INCLUDE THOSE OF A MINOR NATURE

USMC INFLECTED ENEMY CASUALTIES

KIA	PW	WPNS
80,286	4,119	20,630

ENEMY CASUALTIES ARE COMPILED DAILY FROM THE
III MAF HISSUM AND ARE RECONCILED MONTHLY WITH
THE FMFPAC SUMMARY OF USMC OPERATIONS IN RVN

TYPICAL DISPOSITION OF 100 USMC WIA *

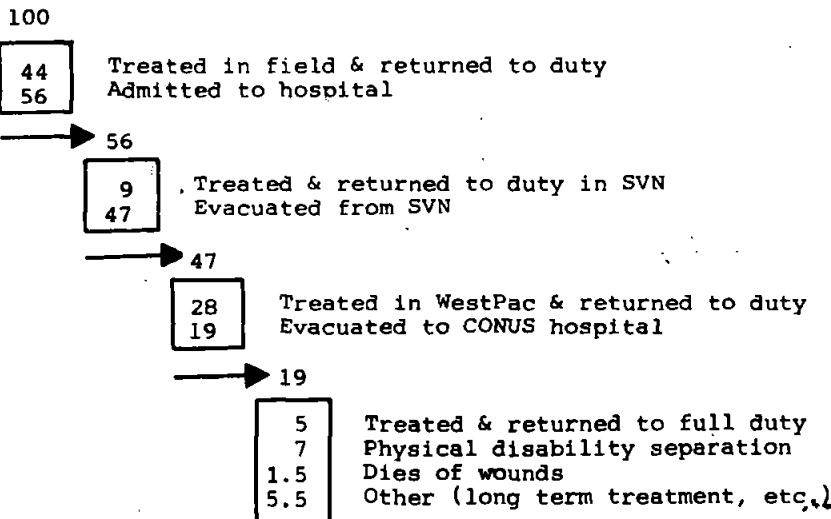

*54,081 CASUALTIES, JAN67-DEC68.

Unclassified

UNCLASSIFIED

~~CONFIDENTIAL~~
UNCLASSIFIED

MARINE CORPS COMMAND CENTER

MILITARY FORCES IN RVN *

10 FEBRUARY 1970

RVN ARMED FORCES (RVNAF)

ARMY (ARVN)	416,278
NAVY (VNN)	30,143
AIR FORCE (VNAF)	36,469
MARINE CORPS (VNMC)	11,528
REGIONAL FORCES (RF)	260,455
POPULAR FORCES (PF)	214,383
TOTAL RVNAF	969,256

UNITED STATES FORCES

ARMY	332,158
NAVY	29,526
AIR FORCE	57,087
MARINE CORPS	52,980
COAST GUARD	375
TOTAL U.S.	472,126

FREE WORLD MILITARY ASSISTANCE FORCES (FWMAF)

REPUBLIC OF KOREA	48,893
AUSTRALIA	7,692
PHILIPPINES	142
THAILAND	11,566
NEW ZEALAND	556
REPUBLIC OF CHINA	28
SPAIN	10
TOTAL FWMAF	68,887

TOTAL FORCES IN RVN 1,510,269

SOURCE: RVNAF MACV MONTHLY GVEN FORCES STRENGTH DATA REPORT.

ALL OTHER, MACV WEEKLY STRENGTH REPORT AS OF 2400,
5FEB70. USMC STRENGTH: MACV WK STRENGTH REPORT AND
AS ADJUSTED BY MACV RPT OF ARR/DEP AS OF 2400, 8FEB70.

Unclassified
UNCLASSIFIED

~~CONFIDENTIAL~~

MARINE CORPS COMMAND CENTER

UNCLASSIFIED

LANDING FORCE, SIXTH FLEET 3-69

10 FEBRUARY 1970

UNITS EMBARKED	STRENGTH				ARMS & EQUIPMENT	LOCATION
	USMC		USN			
	OFF	ENL	OFF	ENL		
TF-61/62 CTG: LTCOL G. B. CRIST					31 7.62 MG 10 LVTP-5 6 105 HOW 5 90MM GUN TANK 5 ONTOS 8 81MM MORTARS 8 FLAME THROWERS 6 106MM RR	AT NAVPLION GREECE.
BLT 2/6 (LTCOL G. B. CRIST)						
2D BN, 6TH MAR	49	1030	4	33		
DET HQCO, 6TH MAR						
BTRY "E", 2/10	9	124				
DET HQ BTRY, 2/10	2	10		2		
PLT CO "C", 2D AMTRAC BN	1	45				
PLT CO "B", 8TH MT BN		19				
PLT CO "C", 2D AT BN	1	21				
PLT CO "B", 2D ENGR BN		49				
PLT CO "A", 2D MED BN		10	1	9		
PLT CO "A", 2D TK BN	1	24			21 MULES 32 MITES	
PLT CO "A", 2D SP BN	1	49			22 2 1/2 TON TRUCKS 8 JEEPS	
PLT CO "B", 2D RECON BN	1	24		1	3 5 TON CARGO TRUCKS 9 3/4 TON UTIL TRUCKS	
DET HQBN, 2D MARDIV		27			4 AMBULANCES 4 CRANES	
DET 2D DENTAL CO			2	2		
DET 2D SERVICE BN	1	42				
DET 2D FSR		40				
TOTALS	66	1514	7	47	AIRCRAFT NO AIRCRAFT	SHIPPING USS CAMBRIA (APA-36) USS LASALLE (LPD-3) USS RUSHMORE (LSD-14) USS WAHIAKUM (LST-1162)
						SUPPLIES CLASS I CLASS II CLASS III CLASS IV CLASS V

LANDING FORCE, CARIBBEAN 1-70

7 FEBRUARY 1970

UNITS EMBARKED	STRENGTH				ARMS & EQUIPMENT	LOCATION
	USMC		USN			
	OFF	ENL	OFF	ENL		
TASK GROUP 45.9 CTG: COL G. R. HUNTER					11 LVTP-5 5 M48 TANK 5 M50 ONTOS 6 105MM HOW TD 8 106MM RR 8 81MM MORTAR	AT CRISTOBAL
HQ 36TH MEU BLT 3/2 (LTCOL E. F. PIERSON JR.)						
3D BN, 2D MARINES	44	1007	4	38		
BTRY "I", 3/10	10	136	1	2		
DET HQ BTRY, 3/10						
PLT CO "B", 2D AMTRAC BN	1	40				
PLT CO "C", 2D MT BN	1	33				
PLT CO "A", 2D AT BN	1	21				
PLT CO "A", 2D ENGR BN	1	49				
PLT H&S CO, 2D MED BN		10		17		
PLT CO "A", 2D TANK BN	1	24				
PLT CO "A", 2D SP BN	1	52		7		
PLT CO "C", 2D RECON BN	1	23		1		
DET HQBN, 2D MARDIV	1	25				
DET 2D DENTAL CO			1	1		
DET 2D SERV BN	1	40				
DET 2D FSR	1	37				
DET HQCO 2D MARINES		20				
HMM-261 (LTCOL V. M. HAZELBAKER)	43	170	1			
TOTALS	107	1687	7	61	AIRCRAFT 19 CH-46D	SHIPPING USS GUADALCANAL (LPH-7) USS VERMILLION (LKA-107) USS SUFFOLK CTY (LST-1173) USS SPEIGEL GROVE (LSD-32)
						SUPPLIES CLASS I CLASS II CLASS III CLASS IV CLASS V

UNCLASSIFIED

Unclassified

~~CONFIDENTIAL~~

MARINE CORPS COMMAND CENTER

SELECTED PERSONNEL AND AIRCRAFT DATA

PERSONNEL

11 FEBRUARY 1970

	STRENGTH	PERCENT USMC	PERCENT FMF	PERCENT FMFPAC
USMC TOTAL	300,982 *	100.00		
FLEET MARINE FORCES	153,729	51.08	100.00	
FMF ATLANTIC	45,696 \$	15.18	29.73	
FMF PACIFIC	108,033 #	35.90	70.27	
VIETNAM	52,970 †	17.60	34.46	49.04

SOURCE: * MONTHLY USMC PERSONNEL ALLOCATION REPORT OF 30NOV69.
 \$ MCCC UNIT REPORT OF 4FEB70.
 # MCCC UNIT REPORT OF 21JAN70.
 † MACV WEEKLY STRENGTH REPORT AS OF 2400, 5FEB70. AS ADJUSTED BY THE MACV DAILY RPT OF ARR/DEP AS OF 2400, 9FEB70.

AIRCRAFT

5 FEBRUARY 1970

	FIXW	HELO	TOTAL	PERCENT USMC	PERCENT FMF	PERCENT FMFPAC
USMC TOTALS	1013	569	1582	100.00		
FLEET MARINE FORCES	763	543	1306	82.55	100.00	
FMF ATLANTIC	303	156	459	29.01	35.15	
FMF PACIFIC	460	387	847	53.54	64.85	
VIETNAM	156	178	334	21.11	25.57	39.43

SOURCE: MARINE CORPS COMMAND CENTER UNIT REPORT OF 31DEC69.

~~UNCLASSIFIED~~

Unclassified

~~CONFIDENTIAL~~

UNCLASSIFIED

FLEET MARINE FORCE DEPLOYMENTS

11 FEBRUARY 1970



1ST MAR BRIG
HAWAII

I MEF
OKINAWA & JAPAN

DET HJBN 10TH MAR
DET 1/10
DET 2/10
DET 3/10
DET 4/10
DET 2D FAG
DET 1, HMM 264
ENR VIEQUES FOR FIREX

GTMO AUGMENT
2D BN, 8TH MAR
BTRY B/1/10
PLT 2D TK BN
PLT 2D ANGLICO
DET FSR

LANFORCARIB 1-70.
BLT 3/2 & HMM-261
AT CRISTOBAL

LANFOR6THFLT 3-69
AT NAUPLION
GREECE

III MAF
RVN

SLF, 7TH FLEET
SLF BRAVO
ENR TAIWAN
ETA: 13FEB70

DET 12TH MAR "D" CO,
3D RECON BN AT FUJI
FOR TRNG.

SLF ALFA
AT OKINAWA

DISTRIBUTION OF MAJOR FMF UNITS

	INF BNS	VMFA	VMA	VMA(AW)	VMCI	HMM	HMR	HML	VMO	VMGR
WESTPAC	18	5	2	3	1	6	2	2	2	1
RVN	(12)	(3)	(2)	(2)	(1)	(4)	(1)	(2)	(1)	
OKINAWA/JAPAN	(4)	(2)		(1)			(1)		(1)	(1)
ASSIGNED TO SLF'S	(2)					(2)				
MIDPAC	1	2								
HAWAII	(1)	(2)								
AFLOAT										
EASTPAC	2	* 3	2		1	2	2	1		1
WEST COAST	(2)	(3)	(2)		(1)	(2)	(2)	(1)		(1)
AFLOAT										
ATLANTIC	8	5	2	3	1	4	2		1	1
EAST COAST	(6)	(5)	(2)	(3)	(1)	(3)	(2)		(1)	(1)
CARIBBEAN	(2)					(1)				
EUROPE	1									
MEDITERRANEAN	(1)									
GRAND TOTAL	30	15	6	6	3	12	6	3	3	3

* CATRE

UNCLASSIFIED

Unclassified

SELECTED UNIT COMMANDERS AND STAFF OFFICERS

11 FEBRUARY 1970

UNCLASSIFIED

HEADQUARTERS FLEET MARINE FORCE PACIFIC

COMMANDING GENERAL	LTGEN H. W. BUSE, JR.
DEPUTY COMMANDER	MGEN P. J. FONTANA
CHIEF OF STAFF	BGEN L. H. WILSON
ACOS, G-1	COL F. S. WOOD
ACOS, G-2	COL J. F. MITCHELL
ACOS, G-3	COL R. M. HALL
ACOS, G-4	COL J. B. SOPER
ACOS, G-5	LTCOL E. L. HICKAM

5TH MARINE EXPEDITIONARY BRIGADE

COMMANDING GENERAL	BGEN R. T. DWYER, JR.
ADC	
CHIEF OF STAFF	COL M. W. SCHMIDT
ACOS, G-1	COL E. R. DAZE
ACOS, G-2	MAJOR J. D. LITTLE
ACOS, G-3	COL J. P. KELLY
ACOS, G-4	COL G. R. STURDIVAN
HQ BN	LTCOL J. F. HEL
H&SCO	MAJ J. A. LINNEMANN
3RD MARINES	
COMMANDING OFFICER	COL W. A. BUTCHER
2ND BATTALION	LTCOL E. Z. GRABOWSKI
3RD BATTALION	LTCOL J. G. COLLIER
1STBN, 12THMAR	
M BTRY, 4THBN, 12THMAR	LTCOL J. F. HELSEL
CoA, 3D AT BN	CAPT C. W. FATTIG
CoA, 3D RECON BN	CAPT R. E. FIELDS, JR.
CoB, 3D ENGR BN	CAPT A. A. LOPEZ
CoB, 3D MT BN	CAPT M. A. SELBY
Co B, 3D SP BN	MAJ E. V. SULLIVAN, JR.
Co D, 3D TANK BN	CAPT W. J. DIBELLO
DET, 3D SERVICE BN	COL G. K. REID
COMM SPT CO, 9TH COMM BN	
Co B, 11TH ENGR BN	MAJ W. B. LUDWICK
Co B, 9TH MT BN	CAPT H. L. CAMPBELL
Co A, 1ST AMTRAC BN	CAPT C. D. GARRETT
1ST SEARCHLIGHT BTRY	MAJ R. G. JONES
9TH SEP BULK FUEL CO	CAPT K. C. KALBFLEISCH
3D BRIDGE CO	MAJ M. E. MC PHERSON
1ST ARMD AMPHIB CO	CAPT J. P. MEREDITH
1ST CIVIL AFFAIRS GROUP	MAJ R. D. DASCH
3D HOSP CO	COL R. M. TAYLOR
Co C, 3D MED BN	LT E. J. CARLISLE (USN)
DET #3, 5TH DENT CO	LCDR C. H. MCALLISTER

1ST MARINE BRIGADE

COMMANDING OFFICER	COL B. G. CASS
S-1	LTCOL W. H. WAHFELD
S-2	CWO P. B. MURPHY
S-3	LTCOL J. R. W. COCHRAN
S-4	LTCOL E. L. CONROY
H&SCO	MAJ J. G. HANRAHAN
1ST BN, 3D MARINES	LTCOL D. J. HUNTER
MAG-24	
COMMANDING OFFICER	COL K. C. PALMER
H&MS-24	LTCOL W. H. HEINTZ
MABS-24	LTCOL A. B. COLBERT
MACS-2	LTCOL R. D. MILLER
VMFA-212	LTCOL H. H. ZIEGLER
VMFA-235	LTCOL L. A. MAHERA
MAFCU-70	MAJOR H. B. VERGARA
SU#2, 1ST RAD BN	MAJOR L. K. RUSSELL
DET#1, 5TH DENT CO	CDR J. D. CRAWFORD

FORCE TROOPS FMPAC

COMMANDING GENERAL	BGEN C. W. HOFFMAN
ASSISTANT COMMANDER	COL A. B. CLARK
CHIEF OF STAFF	COL L. N. UTTER
ACOS, G-1	LTCOL D. K. GRAY
ACOS, G-2	1STLT R. COOK
ACOS, G-3	LTCOL W. R. MILLER, JR.
ACOS, G-4	LTCOL M. E. FARMER
3RD FORCE SERVICE REGT	
COMMANDING OFFICER	COL J. R. JONES
H&S BATTALION	LTCOL J. B. HARRIS
SUPPLY BATTALION	LTCOL R. E. ROURKE
MAINT BATTALION	LTCOL L. I. FEIN
5TH FORCE SERVICE REGT	
COMMANDING OFFICER	COL K. W. HENRY
H&S BATTALION	MAJOR J. A. SCHEARMAN, JR.
SUPPLY BATTALION	LTCOL R. O. BARNES
MAINT BATTALION	LTCOL J. M. HERMES
13TH MT BATTALION	MAJOR T. M. COLLINS
9TH COMM BATTALION	MAJ C. E. TEAGUE

UNCLASSIFIED

SELECTED UNIT COMMANDERS AND STAFF OFFICERS

11 FEBRUARY 1970

UNCLASSIFIED

HEADQUARTERS, I MEF

COMMANDING GENERAL	MGEN W. K. JONES
CHIEF OF STAFF	COL C. J. BAILEY, JR.
ACOS, G-1	MAJOR R. E. DOLAN
ACOS, G-2	LTCOL J. A. MACINNIS
ACOS, G-3	COL H. S. WILSON
ACOS, G-4	COL J. H. KEITH, JR.
CEO	LTCOL R. G. DEEM

3D MARINE DIVISION

COMMANDING GENERAL ADC/CG 11TH MEB	MGEN W. K. JONES BGEN L. E. FRIBOURG
CHIEF OF STAFF	COL R. P. WRAY
ACOS, G-1	LTCOL W. S. DANIELS
ACOS, G-2	COL C. G. MOODY, JR.
ACOS, G-3	COL E. R. REID
ACOS, G-4	COL R. C. DAMM
ACOS, G-5	LTCOL M. J. GOTT
ACOS, COMPT	LTCOL E. F. GRAYSON
CEO	LTCOL A. D. BEACH
<u>4TH MARINES</u>	
COMMANDING OFFICER	COL W. E. BARRINEAU
1ST BATTALION	LTCOL W. A. HOLMBERG
2ND BATTALION	LTCOL D. J. GARRETT
3RD BATTALION	LTCOL J. P. KEHOE
<u>9TH MARINES</u>	
COMMANDING OFFICER	COL R. J. THOMAS
1ST BATTALION	LTCOL D. J. MCADAMS
2ND BATTALION	LTCOL J. R. VANDENELZEN
3RD BATTALION	LTCOL H. M. HART
<u>12TH MARINES (-)</u>	
COMMANDING OFFICER	COL W. W. CROMPTON
2ND BATTALION	LTCOL F. W. STCLAIR
3RD BATTALION	LTCOL D. R. MCMILLAN, JR.
4TH BATTALION	LTCOL H. H. BAIR
<u>5LF BRAVO</u>	
COMMANDER	COL G. G. CHAMBERS, JR.
BLT 2/9	LTCOL J. R. VANDENELZEN
HMM-165	LTCOL D. H. MITCHELL
<u>5LF ALFA</u>	
COMMANDER	COL C. W. BOYD, JR.
BLT 1/9	LTCOL D. J. MCADAMS
HMM-164	MAJOR E. L. KUYKENDALL
HQS BATTALION	LTCOL C. F. KING, JR.
3RD AT BATTALION	
3RD ENGR BATTALION (-)	LTCOL J. W. MEDIS
3RD RECON BATTALION (-)	LTCOL R. I. KRAMER
3RD MT BATTALION (-)	MAJOR R. S. DAVIS
3RD SP BATTALION (-)	LTCOL E. E. PARO, JR.
3RD MED BATTALION	CAPT(MC) J. V. BROWN
3RD TANK BATTALION (-)	LTCOL R. W. MARTIN
7TH COMM BATTALION (-)	MAJOR A. E. HARWOOD
9TH MT BATTALION (-)	MAJOR L. D. BERRYBERRY
3RD SERV BATTALION (-)	COL J. M. KEELEY
11TH ENGR BATTALION	LTCOL B. A. KASSMAN
1ST AMTRAC BATTALION	MAJOR A. W. LAMB

1ST MAW (REAR)

COMMANDING GENERAL	BGEN W. G. JOHNSON
CHIEF OF STAFF	COL E. E. PEARCY
ACOS, G-1	MAJOR W. J. KLIMEK
ACOS, G-2	MAJOR F. G. NEWCOMB
ACOS, G-3	MAJOR J. W. PERSONS
ACOS, G-4	COL R. J. BARBOUR
ACOS, G-5	
CEO	MAJOR M. S. VALENTINI
H&HS-1 (REAR)	MAJOR H. R. STENNIS
<u>MAG-15</u>	
COMMANDING OFFICER	COL E. E. PEARCY
H&MS-15	MAJOR L. K. WARN
MABS-15	LTCOL R. MACARTHUR
VMFA-334	LTCOL J. R. BRADDON
VMFA-232	LTCOL R. J. SORENSON
VMA(AW)-533	LTCOL D. L. HARVEY
<u>MAG-36</u>	
COMMANDING OFFICER	COL O. V. GALLENTE
H&MS-36	MAJOR J. F. GOLDEN
MABS-36	MAJOR E. W. LOCKARD
VMGR-152	LTCOL A. H. MANHARD, JR.
HMM-164	MAJOR R. D. FOWNER
HMM-165	LTCOL D. H. MITCHELL
HMM-462	LTCOL T. F. LOTTSFELDT
VMO-6	MAJOR J. A. BRANDON
<u>MACG-18 (REAR)</u>	
COMMANDING OFFICER	LTCOL P. E. SHEA
H&HS-18 (REAR)	MAJOR R. L. GOODLAKE
MACS-8	LTCOL G. G. LONG
MASS-2	MAJOR J. D. ODEN

UNCLASSIFIED

~~SECRET~~

UNCLASSIFIED

MARINE CORPS COMMAND CENTER

MARINE CORPS PERSONNEL IN RVN

11 FEBRUARY 1970

	OFF	ENL	TOTAL
* III MAF.	3,509	49,150	52,659
DANANG	(3,009)	(42,715)	(45,724)
CHU LAI	(388)	(4,851)	(5,239)
PHU BAI	(77)	(880)	(957)
DONG HA	(35)	(704)	(739)
SU #1, 1ST ANGLICO (AT VARIOUS LOCATIONS SVN)	((21))	((191))	((212))
OTHER USMC PERSONNEL	159	152	311
MACV STAFF/MACV FIELD	(136)	(139)	(275)
NAVADVGRU/NAVY UNITS	(23)	(13)	(36)
USMC IN RVN CHARGED AGAINST PROGRAM VIII	3,668	49,302	52,970
U. S. NAVY, III MAF.	259	1,839	2,098

* AS REPORTED BY III MAF DAILY ADMIN SITREP # 038 AS OF 2400, 6FEB70 AND THE MACV WEEKLY STRENGTH REPORT, AS OF 2400, 5FEB70. AS ADJUSTED BY MACV DAILY RPT OF ARR/DEP AS OF 2400, 9FEB70.

Unclassified

UNCLASSIFIED

~~SECRET~~

WESTPAC UNIT LOCATIONS

11 FEBRUARY 1970

QUANG TRI

(QUANG TRI)

UNCLASSIFIED

USMC 739
USN 38
USA 5,808

- 1ST BDE, 5TH INF DIV (MECH)
- 1/77 ARMOR (OPN GREENE RIVER)
- 1/61 INF (MECH) (OPN GREENE RIVER)
- 1/11 INF (OPN GREENE RIVER)
- 3/5 ARMD CAV SQDN (OPN GREENE RIVER)

THUA THIEN

HO, XXIV CORPS (PHU BAI)

HO, 101st ABN DIV (AM)

- 1ST BDE, 101ST ABN DIV (AM)
- 1/327 INF (AM) (OPN RANDOLPH GLEN)
- 2/327 INF (AM) (OPN RANDOLPH GLEN)
- 2/502 INF (AM) (OPN RANDOLPH GLEN)

- 2D BDE, 101ST ABN DIV (AM)
- 1/501 INF (AM) (OPN RANDOLPH GLEN)
- 2/501 INF (AM) (OPN RANDOLPH GLEN)
- 1/502 INF (AM) (OPN RANDOLPH GLEN)

- 3D BDE, 101ST ABN DIV (AM)
- 1/506 INF (AM) (OPN RANDOLPH GLEN)
- 2/506 INF (AM) (OPN RANDOLPH GLEN)
- 3/187 INF (AM) (OPN RANDOLPH GLEN)

USMC 957
USN 47
USA 26,177

1st MAW
MAG-16
HML-367 (UH-1E)

QUANG NAM

HQS 1ST MAR DIV (DANANG)

- 1ST MARINES
- 1/1
- 2/1
- 3/1

- 5TH MARINES
- 1/5
- 2/5
- 3/5

- 7TH MARINES
- 1/7
- 2/7
- 3/7

- 26TH MARINES
- 1/26
- 2/26
- 3/26

HQS, III MAF

HO 1st MAW
MAG-11

- VMA(AW)-242 (A-6A)
- VMA(AW)-225 (A-6A)
- VMCJ-1 (RF-4/EA-6/EF-10)
- VMO-2 (AH-1G/OV-10A)

- MAG-16 (-)
- HML-167 (UH-1E)
- HMH-463 (CH-53A)
- HMM-364 (CH-46D)
- HMM-263 (CH-46D)
- HMM-262 (CH-46D)
- HMM-161 (CH-46D)

2d ROKMC BDE

- 1/2 (OPN VICTORY DRAGON 20-31)
- 2/2 (OPN VICTORY DRAGON XIX-21)
- 3/2 (OPN VICTORY DRAGON XIX)
- 5/2 (OPN VICTORY DRAGON XIX)

USMC 45,724
USN 1,889
USA 1,090
ROKMC 7,145

FLC 1ST FSR/FLSG-B/1ST SERV BN

QUANG TIN/QUANG NGAI

HO 23d INF DIV (AMERICAL) (CHU LAI)

- 196TH LT INF BDE
- 2/1 INF (OPN FREDERICK HILL)
- 4/31 INF (OPN FREDERICK HILL)
- 3/21 INF (OPN FREDERICK HILL)
- 1/46 INF

- 198TH LT INF BDE
- 1/6 INF (OPN GENEVA PARK)
- 1/52 INF (OPN GENEVA PARK)
- 5/46 INF (OPN NANTUCKET BEACH)

- 11TH INF BDE
- 1/20 INF (OPN IRON MOUNTAIN)
- 4/21 INF (OPN IRON MOUNTAIN)
- 3/1 INF (OPN IRON MOUNTAIN)
- 4/3 INF (OPN IRON MOUNTAIN)
- 1/1 ARMD CAV SQDN (OPN IRON MOUNTAIN)

- 1st MAW
- MAG-12 (A-4E)
- VMA-211 (A-4E)
- VMA-311 (A-4E)

- MAG-13
- VMFA-115 (F-4B)
- VMFA-314 (F-4B)
- VMFA-122 (F-4B)

USMC 5,239
USN 124
USA 24,331

OKINAWA

HO, I MEF
3D MAR DIV (-) (REIN)(TF-79)
11th MEB (TF-79.1)

- 4TH MARINES
- 1/4
- 2/4
- 3/4

9TH MARINES
3/9

- MAG-36
- VMGR-152 (KC-130F)
- VMO-6 (OV-10A/UH-1E)
- HMH-462 (CH-53A)

- 3D FSR 13,456 (50)
- MCB CAMP BUTLER/NON FMP (915) (25)
- Non-Deployable Casuals (148) (0)
- SVN-Originated Patients (0)

USMC 19,200
USN 934

ACTUALS CHARGED AGAINST PROGRAM VIII AS OF 5FEB70 18,580 424

(14,061 (349)

USMC RVN RECAP

USMC USN

OSD PROGRAM VIII CEILING 55,510 2,233

ACTUALS CHARGED AGAINST PROGRAM VIII AS OF 9FEB70 52,970 2,098

III MAF 52,655 2,098

SU#1 1ST ANGLICO (212) (14)

OTHER 311

MACV STAFF/MACV FIELD. (275)

NAVAIDVGRU/NAVY UNITS (36)

I CORPS RECAP

US MARINE CORPS (12 BNs) 52,659

US ARMY (25 BNs) 73,849

US NAVY 17,012

US AIR FORCE 8,194

ROKMC (4 BNs) 6,148

RVNAF (36 BNs) 153,895

ARVN/ABN (36 BNs) (74,634)

VNMC

VNN (2,100)

VNAF (3,408)

VNRF (37,403)

VNPF (36,350)

I CORPS TOTAL 77 BNs 311,757

SLF 7TH FLEET

USMC USN

BRAVO: BLT 2/9 1,847 60

HMM-165

ENR TAIWAN

ETA: 13FEB70

ALFA: BLT 1/9 1,868 85

HMM-164

AT OKINAWA

MOVEMENTS

Det 12th Mar and "D" Co, 3d Recon Bn. At Fuji for training.

JAPAN

USMC USN

OSD PROGRAM VIII CEILING 3,600 45

ACTUALS CHARGED AGAINST PROGRAM VIII AS OF 5FEB70 3,749 34

1ST MAW (REAR)

- MAG-15 (2,553) (34)
- VMFA-232 (F-4J)
- VMFA-334 (F-4J)
- VMA(AW)-533 (A-6A)

*Does NOT include 243 hospitalized SVN-Originated Patients.

Non FMP (1,196)

* Includes only U. S. Navy Personnel organic to FMP Units.
Includes SU#1 and 1st ANGLICO at various locations throughout SVN.
• Latest Change

Unclassified

UNCLASSIFIED

MARINE CORPS
FEB 11 1970
REFERENCE BRANCH

Unclassified

SECRET

UNCLASSIFIED

SUMMARY OF MAJOR RVNAF OPERATIONS

OPERATION (DATE COMMENCED)	UNITS INVOLVED	LOCATION	CASUALTIES AS OF: 112400H FEB70		
			FRIENDLY		ENEMY
			KIA	WIA	KIA
LAM SON 350 (1JAN70)	2ND REGT: 1/2, 2/2, 3/2, 4/2 & 5/2	5 KM E OF GIO LINH	15	65	161
LAM SON 353 (1JAN70)	7TH CAV: 3/7 CAV	5 KM SE OF GIO LINH	6	33	14
LAM SON 354 (6JAN70)	54TH REGT: 3/54	6 KM S OF QUANG TRI CITY	1	1	1
LAM SON 352 (1JAN70)	54TH REGT: 1/54, 2/54 & 4/54	2 KM NW OF PHU BAI	1	7	20
LAM SON 349 (1JAN70)	1ST REGT: 1/1, 2/1, 3/1 & 4/1	21 KM NW OF A LUOI	8	45	119
LAM SON 351 (1JAN70)	3RD REGT: 1/3, 2/3, 3/3 & 4/3	25 KM SW OF HUE	5	22	31
HUNG QUANG 1/22 (12JAN70)	51ST REGT: 1/51	16 KM NW OF HOI AN	NONE	5	NONE
QUYET THANG 54 (2JAN70)	5TH REGT: 1/5, 2/5, 4/5, 2/6 & 4/6	12 KM W OF TAM KY	20	53	131
QUYET THANG 63 (2JAN70)	6TH REGT: 3/6	18 KM NW OF QUANG NGAI CITY	16	82	81
QUYET THANG 45 (4JAN70)	4TH REGT: 1/4, 2/4, 3/4 & 4/4	11 KM SW OF DUC PHO	17	47	217

ALL UNITS ARE ARVN UNLESS DESIGNATED
 * - ADJUSTED
 # - FINAL CUMULATIVE CASUALTIES

UNCLASSIFIED

Unclassified

UNCLASSIFIED
SUMMARY OF MAJOR US AND FWMAF OPERATIONS

OPERATION (DATE COMMENCED)	UNITS INVOLVED	LOCATION	CASUALTIES AS OF: 112400H FEB70		
			FRIENDLY		ENEMY
			KIA	WIA	KIA
GREENE RIVER (19JAN70)	1ST BDE, 5TH INF DIV (MECH): 4 USA BNS	EASTERN QUANG TRI PROVINCE	4	90	46
RANDOLPH GLEN (7DEC69)	101ST ABN DIV (AM): 9 USA BNS	QUANG TRI & THUA THIEN PROVINCES	55	255	380
VICTORY DRAGON XIX (1JAN70)	2D ROKMC BDE: 4 ROKMC BNS	HOI AN AREA	1	11	9
FREDERICK HILL (18MAR69)	196TH INF BDE: 3 USA BNS	QUANG TIN PROVINCE	369	2,323	4,451
GENEVA PARK (18JUL69)	198TH INF BDE: 2 USA BNS	QUANG TIN & QUANG NGAI PROVINCES	125	855	1,125
NANTUCKET BEACH (20JUL69)	198TH INF BDE: 1 USA BN	CENTERED 15 KM NE OF QUANG NGAI CITY	23	206	244
IRON MOUNTAIN (13MAR69)	11TH INF BDE: 5 USA BNS	QUANG NGAI PROVINCE	287	1,642	2,466
VICTORY DRAGON XIX-21 (31JAN70) (TERM: 100900H)	2D ROKMC BDE: 1 BN	HOI AN AREA	#1	#3	#1
VICTORY DRAGON 20-31 (4FEB70) (TERM: 110900H)	2D ROKMC BDE: 1 BN	HOI AN AREA	#NONE	#1	#1

UNCLASSIFIED

* - ADJUSTED
 # - FINAL CUMULATIVE CASUALTIES

Unclassified

UNCLASSIFIED

MARINE CORPS COMMAND CENTER

USMC/ENEMY CASUALTIES IN RVN

11 FEBRUARY 1970

USMC BATTLE CASUALTIES

KIA/DOW	WIA(EVAC)	WIA(RTD)	MIA/PW
12,446	48,803	35,778	83/21

USMC CASUALTY FIGURES ARE PROVIDED DAILY BY HQMC CASUALTY SECTION (CODE DNA) AND REFLECT ALL CASUALTIES REPORTED AS OF 10FEB70.

USMC NON-BATTLE CASUALTIES

DEAD	INJURED	MISSING
1,503	1,821	9

FIGURES INDICATED AS INJURED ARE ONLY THOSE IN SERIOUS/CRITICAL INJURY OR DISEASE CATEGORY AND DO NOT INCLUDE THOSE OF A MINOR NATURE

USMC INFLICTED ENEMY CASUALTIES

KIA	PW	WPNS
80,329	4,120	20,632

ENEMY CASUALTIES ARE COMPILED DAILY FROM THE III MAF HISSUM AND ARE RECONCILED MONTHLY WITH THE FMFPAC SUMMARY OF USMC OPERATIONS IN RVN

TYPICAL DISPOSITION OF 100 USMC WIA *

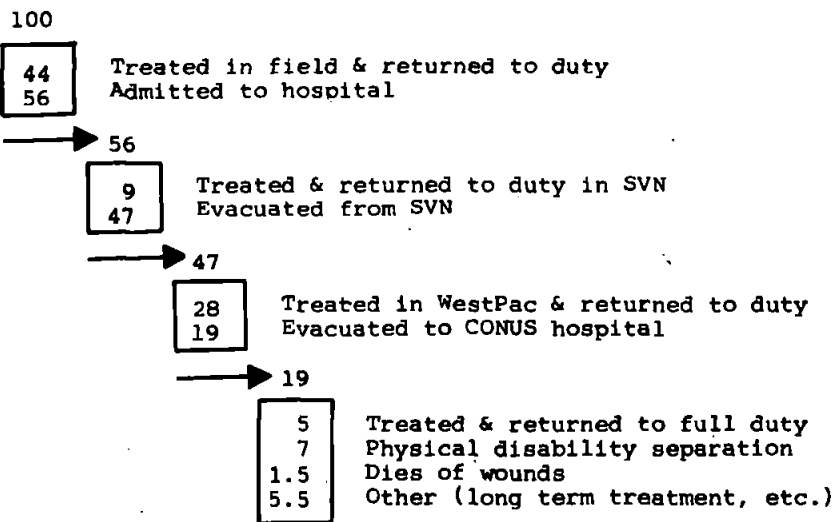

*54,081 CASUALTIES, JAN67-DEC68.

Unclassified

UNCLASSIFIED

MARINE CORPS COMMAND CENTER

UNCLASSIFIED
RVN ARMED FORCES (RVNAF)

MILITARY FORCES IN RVN *

11 FEBRUARY 1970

ARMY (ARVN)	416,278
NAVY (VNN)	30,143
AIR FORCE (VNAF)	36,469
MARINE CORPS (VNMC)	11,528
REGIONAL FORCES (RF)	260,455
POPULAR FORCES (PF)	214,383
TOTAL RVNAF	969,256

UNITED STATES FORCES

ARMY	332,158
NAVY	29,526
AIR FORCE	57,087
MARINE CORPS	52,970
COAST GUARD	375
TOTAL U.S.	472,126

FREE WORLD MILITARY ASSISTANCE FORCES (FWMAF)

REPUBLIC OF KOREA	48,893
AUSTRALIA	7,692
PHILIPPINES	142
THAILAND	11,566
NEW ZEALAND	556
REPUBLIC OF CHINA	28
SPAIN	10
TOTAL FWMAF	68,887

TOTAL FORCES IN RVN 1,510,259

SOURCE: RVNAF MACV MONTHLY GIVEN FORCES STRENGTH DATA REPORT.
 ALL OTHER, MACV WEEKLY STRENGTH REPORT AS OF 2400,
 5FEB70. USMC STRENGTH: MACV WK STRENGTH REPORT AND
 AS ADJUSTED BY MACV RPT OF ARR/DEP AS OF 2400, 9FEB70.

UNCLASSIFIED
Unclassified

~~UNCLASSIFIED~~
~~UNCLASSIFIED~~

CINCPAC
VIETNAM & THAILAND - AIR FORCE

11 FEBRUARY 1970

VIETNAM AIR FORCE

<u>BAN ME THOUT</u>		<u>NHA TRANG</u>		<u>TAN SON NHUT</u>	
UH-1	6	C-123	4	RF-4	33
		C-130	3	C-123	16
				RB-57	4
<u>BIEN HOA</u>				RF-101	14
F-100	22			C-130	17
A-37	65	<u>PHAN RANG</u>		HH-43	2
O-1	58	F-100	74	EC-47	15
O-2	84	C-123	42	AC-119	5
OV-10	44	HH-43	2		
UC-123	13			<u>TUY HOA</u>	
C-7	1	AC-119	14	F-100	83
				HC-130	11
C-47	2			HH-43	2
HH-43	2	<u>PHU CAT</u>		C-47	3
		EC-47	10	O-2	13
		C-7	25	AC-119	5
		F-4	35	UH-1	6
		HH-43	1		
<u>CAM RANH BAY</u>		AC-119	5		
F-4	36			<u>VUNG TAU</u>	
C-7	27	<u>PLEIKU</u>		C-7	31
C-130	38	EC-47	14		
HH-43	2				
O-1	23	HH-43	2		
O-2	63				
RC-130	4				
<u>DA NANG</u>					
F-4	47				
O-2	82				
OV-10	38				
HH-3	13				
HH-43	2				
C-47	1				
A-1	10				
AC-119	6				

THAILAND AIR FORCE

<u>BANGKOK</u>		<u>TAKHLI</u>	
F-102	4	F-105	68
C-130	5	EB-66	18
		HH-43	2
		<u>UBON</u>	
		F-4	77
<u>KORAT</u>		C-130	6
F-4	34	HH-43	3
HH-43	2	AC-130	6
EC-121	26	OV-10	10
C-121	1	AC-123	2
<u>NAKHOM PHANOM</u>			
UC-123	5	<u>UDORN</u>	
C-123	4	RF-4	38
		AC-47	3
		F-4	34
A-1	62		
O-2	12	HH-43	3
OV-10	21	HH-53	5
HH-3	4	C-130	6
CH-3	7	CH-3	4
EC-47	6		
		<u>U-TAPAO</u>	
		HH-43	2

27-1

UNCLASSIFIED

Unclassified

UNCLASSIFIED

US NAVY UNITS IN I CTZ

11 FEBRUARY 1970

	QUANG TRI	THUA THIEN	QUANG NAM	QUANG TIN	QUANG NGAI
NAVAL SUPPORT ACTIVITY	844	701	7,751	731	73
3D NAV CONST BDE			216		
30TH NAV CONST REGT.			14		
MCB-121			731		
MCB-7				729	
32D NAV CONST REGT		31			
MCB- 1			784		
MCB- 74	747				
MCB-10		738			
OTHER UNITS & DETACHMENT	85	94	613	32	
AREA TOTALS	1,676	1,564	10,109	1,492	73

SOURCE: COMMANDER IN CHIEF PACIFIC STRENGTH REPORT FOR THE PRD
ENDING 31DEC69.
NOTE: FIGURES DO NOT INCLUDE USN ORGANIC TO III MAF MARINE UNITS.

I CTZ TOTAL: 14,914

UNCLASSIFIED

SELECTED UNIT COMMANDERS AND STAFF OFFICERS

11 FEBRUARY 1970

HEADQUARTERS FLEET MARINE FORCE ATLANTIC

COMMANDING GENERAL	LTGEN F. E. LEEK
DEPUTY COMMANDER	MGEN C. A. YOUNGDALE
CHIEF OF STAFF	COL J. E. LOPRETE
ACOS G-1	COL H. L. GIVENS, JR.
ACOS G-2	COL D. A. BREWSTER
ACOS G-3	COL J. C. VANCE
ACOS G-4	COL W. R. NOWADNICK

UNCLASSIFIED

2D MARINE DIVISION

COMMANDING GENERAL	MGEN M. P. RYAN
ADC	BGEN R. D. BOHN
CHIEF OF STAFF	COL L. V. CORBETT
ACOS G-1	COL L. S. HOLLIER
ACOS G-2	COL R. M. PLATT
ACOS G-3	COL E. Y. HOLT
ACOS G-4	COL R. J. LAHR

2D MARINES

COMMANDING OFFICER	COL	BRADLEY
1ST BATTALION	LTCOL	W. E. MCKINSTRY
2ND BATTALION	LTCOL	D. C. BINNEY
3RD BATTALION	LTCOL	E. F. PIERSON, JR.

5TH MARINES

COMMANDING OFFICER	COL	P. B. HAIGWOOD
1ST BATTALION	LTCOL	D. M. TWOMEY
2ND BATTALION	LTCOL	G. B. CRIST
3RD BATTALION	LTCOL	J. W. DUNCAN

8TH MARINES

COMMANDING OFFICER	LTCOL	J. R. GREENSTONE
1ST BATTALION	MAJOR	JOHNSON
2ND BATTALION	LTCOL	C. W. ABBOTT
3RD BATTALION	LTCOL	D. M. DUFFIELD

10TH MARINES

COMMANDING OFFICER	COL	T. J. HOLT
1ST BATTALION	LTCOL	R. W. HEESCH
2ND BATTALION	MAJOR	C. A. AUSTIN
3RD BATTALION	LTCOL	D. E. COOMBE
4TH BATTALION	LTCOL	B. F. READ

HQ BN, 2ND MARDIV	COL	J. M. LANDRIGAN
2ND SERVICE BATTALION	LTCOL	H. A. HATCH
2ND AT BATTALION	MAJOR	C. R. BRABEC
2ND MT BATTALION	LTCOL	W. S. GERICHTEN
2ND RECON BATTALION	LTCOL	J. T. SMITH
2ND ENGR BATTALION	LTCOL	G. B. CORNWALL
2ND SP BATTALION	MAJOR	F. E. PAIGE
2ND MED BATTALION	CAPT (MC)	F. W. ARMINGTON
LANFORCARIB 1-70	LTCOL	E. F. PIERSON, JR.
LANFOR6THFLT 3-69	LTCOL	G. B. CRIST
GTMODEFOR	LTCOL	C. W. ABBOTT

FORCE TROOPS FMFLANT

COMMANDING GENERAL	BGEN	J. C. FEGAN JR.
CHIEF OF STAFF	COL	D. A. CLEMENT
ACOS G-1	LTCOL	J. H. LANDERS
ACOS G-2	MAJOR	F. T. WHITMAN
ACOS G-3	LTCOL	E. J. ROCHFORD
ACOS G-4	LTCOL	J. B. CANTINEY

2D FORCE SERVICE REGIMENT

COMMANDING OFFICER	COL	C. H. SCHMID
H&S BATTALION	LTCOL	G. F. TUBLEY
SUPPLY BATTALION	LTCOL	O. H. SAYCE
MAINT BATTALION	LTCOL	C. L. BOOTH
2D TANK BATTALION	LTCOL	J. L. SAUL
8TH COMM BATTALION	LTCOL	R. E. HAISLIP
8TH ENGR BATTALION	LTCOL	W. G. VIERS
8TH MT BATTALION	LTCOL	J. F. JONES
2D RADIO BATTALION	LTCOL	D. L. MITCHELL
2D FLD ARTY GROUP	COL	C. S. KIRCHMANN
2D AMTRAC BATTALION	LTCOL	J. R. CATT
2D ANGLICO	LTCOL	SCHUELER
4TH DENT CO	CAPT	HAGERMAN

2D MARINE AIRCRAFT WING

COMMANDING GENERAL	MGEN	M. E. CARL
AWC	COL	R. R. READ
CHIEF OF STAFF	COL	W. D. WILCOX
ACOS G-1	COL	J. E. HANSEN
ACOS G-2	LTCOL	J. R. STANLEY
ACOS G-3	COL	G. W. MORRISON
ACOS G-4	COL	J. L. HERNDON

MWHG-2

COMMANDING OFFICER	LTCOL	T. W. RIGGS
H&HS-2	LTCOL	J. T. HAGEN
MWFS-2	MAJOR	D. T. SITES
MWCS-2	MAJOR	F. SIMON

MWSG-27

COMMANDING OFFICER	COL	R. M. WILLIAMS
H&MS-27	MAJOR	T. M. WHEELER
WERS-27	LTCOL	A. J. KOHANOWICH
VMGR-252	LTCOL	J. E. FEGLEY

MWCG-28

COMMANDING OFFICER	LTCOL	J. M. JOHNSON
H&HS-28	MAJOR	L. H. SHAY
MAS-1	MAJOR	L. J. DRAAYER
MACS-5	MAJOR	H. M. FIX
MACS-6	LTCOL	P. G. BOOZMAN
MACS-9	LTCOL	A. L. BLAIR
3D LAAM BN	LTCOL	J. C. DIXON

MAG-14

COMMANDING OFFICER	COL	G. H. KELLER, JR.
H&MS-14	LTCOL	J. D. DUNN
MABS-14	MAJOR	K. L. RATT
VMCJ-2	LTCOL	H. C. PERKINS
VMA(AW)-224	LTCOL	F. G. DAWSON
VMA(AW)-121	LTCOL	E. E. JACOBSON, JR.
VMA(AW)-332	LTCOL	R. R. VAN DALSEN
VMFA-513	LTCOL	E. W. BUSCHHAUS

MCCRTG-20

COMMANDING OFFICER	COL	C. H. LUDDEN
H&MS-20	LTCOL	R. C. BARRETT
VMFAT-201	LTCOL	P. L. SIEGMUND
VMAT(AW)-202	LTCOL	T. R. MADDOCK
VMT-203	LTCOL	R. W. CHAPIN

MAG-26

COMMANDING OFFICER	COL	J. A. NELSON
H&MS-26	MAJOR	D. F. KELLEY
MABS-26	MAJOR	H. S. LOWREY, JR.
VMO-1	LTCOL	E. J. MURPHY
HMH-461	LTCOL	C. G. REDMAN
HMM-162	LTCOL	G. S. PATE
HMM-261	LTCOL	V. W. HAZELBAKER
HMM-264	LTCOL	C. E. DORFFELD
HMM-365	LTCOL	R. H. NELSON
HMH-362	LTCOL	M. J. NEEDHAM

MAG-31

COMMANDING OFFICER	COL	V. J. PEEBLES
H&MS-31	LTCOL	R. L. MARTIN
MABS-31	LTCOL	F. B. ROGERS
VMA-331	MAJOR	J. V. SULLIVAN
VMFA-333	LTCOL	J. A. HERBER
VMFA-451	LTCOL	C. U. GEBSEN

MAG-32

COMMANDING OFFICER	COL	H. V. HUFFSTUTTER
H&MS-32	MAJOR	L. F. GAGNON
MABS-32	MAJOR	M. A. YARNELL
VMFA-251	LTCOL	R. O. LAWRENCE
VMFA-312	LTCOL	T. E. BRADLEY
VMA-324	LTCOL	G. M. LAWRENCE JR.

MHTG-40

COMMANDING OFFICER	LTCOL	M. G. ROBBINS
H&HS-40	MAJOR	J. T. GORDON
HMHT-401	LTCOL	D. R. CARPENTER
HMHT-402	LTCOL	D. R. CARPENTER

Unclassified

UNCLASSIFIED

~~CONFIDENTIAL~~

MARINE CORPS COMMAND CENTER

SELECTED PERSONNEL AND AIRCRAFT DATA

UNCLASSIFIED

PERSONNEL

12 FEBRUARY 1970

	STRENGTH	PERCENT USMC	PERCENT FMF	PERCENT FMFPAC
USMC TOTAL	300,982 *	100.00		
FLEET MARINE FORCES	153,729	51.08	100.00	
FMF ATLANTIC	45,696 \$	15.18	29.73	
FMF PACIFIC	108,033 #	35.90	70.27	
VIETNAM	52,936 ¢	17.60	34.46	49.04

SOURCE: * MONTHLY USMC PERSONNEL ALLOCATION REPORT OF 30NOV69.
 \$ MCCC UNIT REPORT OF 4FEB70.
 # MCCC UNIT REPORT OF 21JAN70.
 ¢ MACV WEEKLY STRENGTH REPORT AS OF 2400, 5FEB70. AS ADJUSTED BY THE MACV DAILY RPT OF ARR/DEP AS OF 2400, 10FEB70.

AIRCRAFT

5 FEBRUARY 1970

	FIXW	HELO	TOTAL	PERCENT USMC	PERCENT FMF	PERCENT FMFPAC
USMC TOTALS	1013	569	1582	100.00		
FLEET MARINE FORCES	763	543	1306	82.55	100.00	
FMF ATLANTIC	303	156	459	29.01	35.15	
FMF PACIFIC	460	387	847	53.54	64.85	
VIETNAM	156	178	334	21.11	25.57	39.43

SOURCE: MARINE CORPS COMMAND CENTER UNIT REPORT OF 31DEC69.

UNCLASSIFIED
CONFIDENTIAL

UNCLASSIFIED

MARINE CORPS COMMAND CENTER

FLEET MARINE FORCE DEPLOYMENTS

12 FEBRUARY 1970

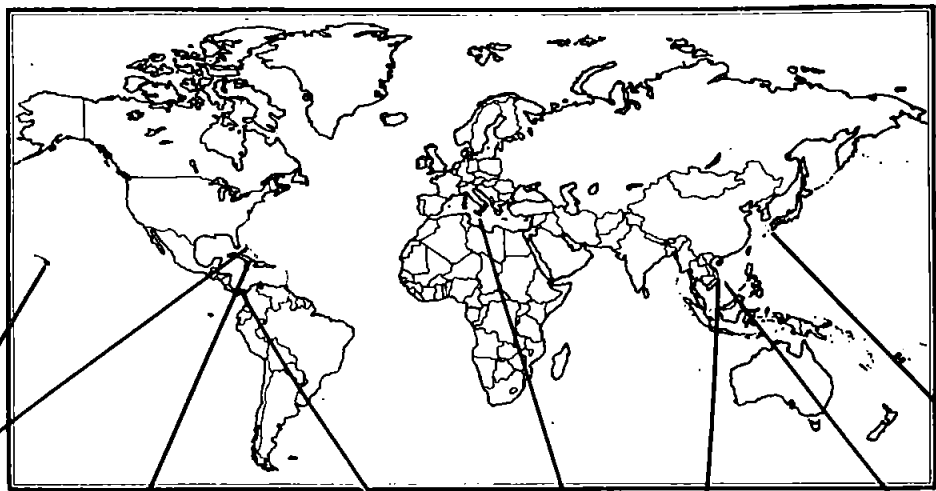

1ST MAR BRIG
HAWAII

DET HQBN 10TH MAR
DET 1/10
DET 2/10
DET 3/10
DET 4/10
DET 2D FAG
DET 1, HMM 264
ENR VIEQUES FOR FIREX

GTMO AUGMENT
2D BN, 8TH MAR
BTRY B/1/10
PLT 2D TK BN
PLT 2D ANGLICO
DET FSR

LANFORCARIB 1-70
BLT 3/2 & HMM-261
AT CRISTOBAL

LANFOR6THFLT 3-69
AT NAVPLION
GREECE

III MAF
RVN

SLF, 7TH FLEET
SLF BRAVO
ENR TAIWAN
ETA: 13FEB70

SLF ALFA
AT OKINAWA

I MEF
OKINAWA
& JAPAN

DET 12TH MAR "D" CO,
3D RECON BN AT FUJI
FOR TRNG.

DISTRIBUTION OF MAJOR FMF UNITS

	INF BNS	VMFA	VMA	VMA(AW)	VMCI	RMH	RMH	HML	VMO	VMGR
WESTPAC	18	5	2	3	1	6	2	2	2	1
RVN	(12)	(3)	(2)	(2)	(1)	(4)	(1)	(2)	(1)	
OKINAWA/JAPAN	(4)	(2)		(1)			(1)		(1)	(1)
ASSIGNED TO SLF'S	(2)					(2)				
MIDPAC	1	2								
HAWAII	(1)	(2)								
AFLOAT										
EASTPAC	2	* 3	2		1	2	2	1		1
WEST COAST	(2)	(3)	(2)		(1)	(2)	(2)	(1)		(1)
AFLOAT										
ATLANTIC	8	5	2	3	1	4	2		1	1
EAST COAST	(6)	(5)	(2)	(3)	(1)	(3)	(2)		(1)	(1)
CARIBBEAN	(2)					(1)				
EUROPE	1									
MEDITERRANEAN	(1)									
GRAND TOTAL	30	15	6	6	3	12	6	3	3	3

* CAFRE

UNCLASSIFIED

Unclassified

~~SECRET~~

UNCLASSIFIED

MARINE CORPS COMMAND CENTER

MARINE CORPS PERSONNEL IN RVN

12 FEBRUARY 1970

	OFF	ENL	TOTAL
* III MAF.	3,509	49,116	52,625
DANANG	(3,009)	(42,681)	(45,690)
CHU LAI	(388)	(4,851)	(5,239)
PHU BAI	(77)	(880)	(957)
DONG HA	(35)	(704)	(739)
SU #1, 1ST ANGLICO (AT VARIOUS LOCATIONS SVN)	((21))	((191))	((212))
OTHER USMC PERSONNEL	159	152	311
MACV STAFF/MACV FIELD	(136)	(139)	(275)
NAVAVGRU/NAVY UNITS	(23)	(13)	(36)
USMC IN RVN CHARGED AGAINST PROGRAM VIII	3,668	49,268	52,936
U. S. NAVY, III MAF.	259	1,839	2,098

* AS REPORTED BY III MAF DAILY ADMIN SITREP #: 038 AS OF 2400, 6FEB70 AND THE MACV WEEKLY STRENGTH REPORT, AS OF 2400, 5FEB70 AS ADJUSTED BY MACV DAILY RPT OF ARR/DEP AS OF 2400, 10FEB70

Unclassified

UNCLASSIFIED

~~SECRET~~

UNCLASSIFIED

MARINE CORPS COMMAND CENTER

WESTPAC UNIT LOCATIONS

12 FEBRUARY 1970

QUANG TRI

(QUANG TRI)

USMC 739
USN 38
USA 5,808

- 1ST BDE, 5TH INF DIV (MECH)
1/77 ARMOR (OPN GREENE RIVER)
1/61 INF (MECH) (OPN GREENE RIVER)
1/11 INF (OPN GREENE RIVER)
3/5 ARMD CAV SQDN (OPN GREENE RIVER)

THUA THIEN

HQ, XXIV CORPS (PHU BAI)

HQ, 101st ABN DIV (AM)

- 1ST BDE, 101ST ABN DIV (AM)
1/327 INF (AM) (OPN RANDOLPH GLEN)
2/327 INF (AM) (OPN RANDOLPH GLEN)
2/502 INF (AM) (OPN RANDOLPH GLEN)

- 2D BDE, 101ST ABN DIV (AM)
1/501 INF (AM) (OPN RANDOLPH GLEN)
2/501 INF (AM) (OPN RANDOLPH GLEN)
1/502 INF (AM) (OPN RANDOLPH GLEN)

1st MAW
MAG-16
HML-367 (UH-1E)

- 3D BDE, 101ST ABN DIV (AM)
1/506 INF (AM) (OPN RANDOLPH GLEN)
2/506 INF (AM) (OPN RANDOLPH GLEN)
3/187 INF (AM) (OPN RANDOLPH GLEN)

USMC 957
USN 47
USA 26,177

QUANG NAM

HQS 1ST MAR DIV (DANANG)

1ST MARINES

- 1/1
2/1
3/1

5TH MARINES

- 1/5
2/5
3/5

7TH MARINES

- 1/7
2/7
3/7

26TH MARINES

- 1/26
2/26
3/26

HQS, III MAF

HQ 1st MAW

MAG-11

- VMA(AW)-242 (A-6A)
VMA(AW)-225 (A-6A)
VMCJ-1 (RF-4/EA-6/EF-10)
VMO-2 (AH-1G/OV-10A)

- MAG-16 (-)
HML-167 (UH-1E)
HMH-463 (CH-53A)
HMM-364 (CH-46D)
HMM-263 (CH-46D)
HMM-262 (CH-46D)
HMM-161 (CH-46D)

2d ROKMC BDE

- 1/2 (OPN VICTORY DRAGON XIX)
2/2 (OPN VICTORY DRAGON XIX)
3/2 (OPN VICTORY DRAGON XIX)
5/2 (OPN VICTORY DRAGON XIX)

USMC 45,690
USN 1,889
USA 1,090
ROKMC 7,145

FLC 1ST FSR/FLSG-B/1ST SERV BN

QUANG TIN/QUANG NGAI

HQ 23d INF DIV (AMERICAL) (CHU LAI)

196TH LT INF BDE

- 2/1 INF (OPN FREDERICK HILL)
4/31 INF (OPN FREDERICK HILL)
3/21 INF (OPN FREDERICK HILL)
1/46 INF

1st MAW

- MAG-12 (A-4E)
VMA-211 (A-4E)
VMA-311 (A-4E)

198TH LT INF BDE

- 1/6 INF (OPN GENEVA PARK)
1/52 INF (OPN GENEVA PARK)
5/46 INF (OPN NANTUCKET BEACH)

MAG-13

- VMFA-115 (F-4B)
VMFA-314 (F-4B)
VMFA-122 (F-4B)

11TH INF BDE

- 1/20 INF (OPN IRON MOUNTAIN)
4/21 INF (OPN IRON MOUNTAIN)
3/1 INF (OPN IRON MOUNTAIN)
4/3 INF (OPN IRON MOUNTAIN)
1/1 ARMD CAV SQDN (OPN IRON MOUNTAIN)

USMC 5,239
USN 124
USA 24,331

OKINAWA

HQ, I MEF
3D MARDIV (-)(REIN)(TF-79)
11th MEB (TF-79.1)

4TH MARINES

- 1/4
2/4
3/4

9TH MARINES

3/9

MAG-36

- VMGR-152 (KC-130F)
VMO-6 (OV-10A/UH-1E)
HMH-462 (CH-53A)

3D FSR (3,456) (50)
MCB CAMP BUTLER/NON FMF (915) (25)
Non-Deployable Casuals (148)
SVN-Originated Patients (0)

USMC 19,200
USN 934
ACTUALS CHARGED AGAINST PROGRAM VIII AS OF 5FEB70.. 18,580 424

(14,061) (349)

USMC RVN RECAP

USMC USN

OSD PROGRAM VIII CEILING 55,510 2,233

ACTUALS CHARGED AGAINST PROGRAM VIII AS OF 10FEB70 52,936 2,098

III MAF 52,625 2,098
SU#1 1ST ANGLICO (212) (14)

OTHER 311
MACV STAFF/MACV FIELD (275)
NAVA/AVGRU/NAVY UNITS (36)

I CORPS RECAP

US MARINE CORPS (12 BNs) 52,625

US ARMY (25 BNs) 73,849

US NAVY 17,012

US AIR FORCE 8,194

ROKMC (4 BNs) 6,148

RVNAF (36 BNs) 153,895

ARVN/ABN (36 BNs) (74,634)

VNMC (2,100)

VNN (3,408)

VNAF (37,403)

VNPF (36,350)

I CORPS TOTAL 77 BNs 311,723

SLF 7TH FLEET

USMC USN

BRAVO: BLT 2/9 1,847 60
HMM-165
ENR TAIWAN
ETA: 13FEB70

ALFA: BLT 1/9 1,868 85
HMM-164
AT OKINAWA

MOVEMENTS

Det 12th Mar and "D" Co, 3d Recon Bn, At Fuji for training.

JAPAN

USMC USN

OSD PROGRAM VIII CEILING 3,600 45

ACTUALS CHARGED AGAINST PROGRAM VIII AS OF 5FEB70. 3,749 34

1ST MAW (REAR)

MAG-15 (2,553) (34)
VMFA-232 (F-4J)
VMFA-334 (F-4J)
VMA(AW)-533 (A-6A)

*Does NOT include 243 hospitalized SVN-Originated Patients.

Unclassified

Non FMF (1,196)

* Includes only U. S. Navy Personnel organic to FMF Units.
Includes SU#1 and 1st ANGLICO at various locations throughout SVN.
Latest Change

UNCLASSIFIED

MARINE CORPS
FEB 12 1970
REFERENCE BRANCH

Unclassified

UNCLASSIFIED

MAJOR RVNAF OPERATIONS IN PROGRESS

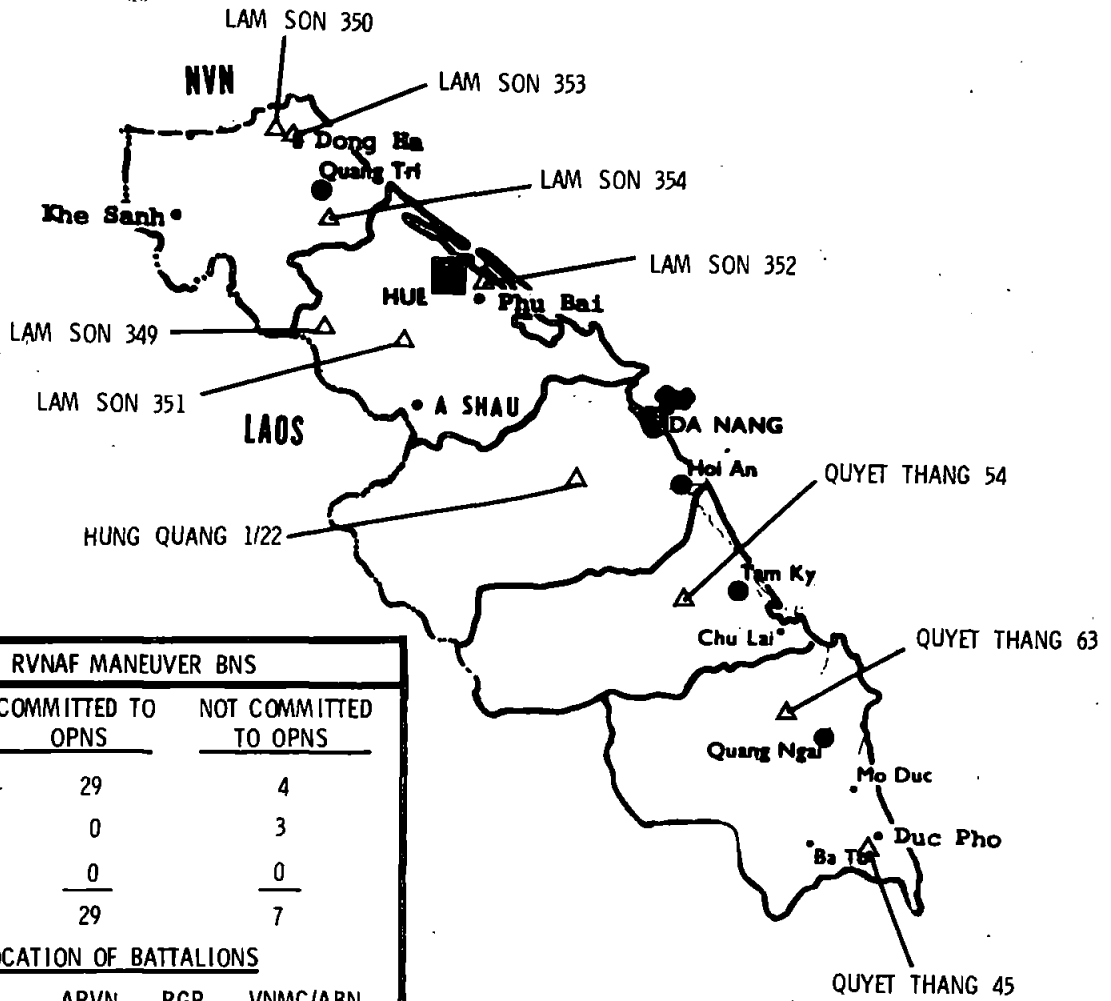

I CTZ RVNAF MANEUVER BNS			
TOTAL BNS	COMMITTED TO OPNS	NOT COMMITTED TO OPNS	
ARVN	33	29	4
RANGER	3	0	3
VNMC/ABN	0	0	0
	36	29	7

LOCATION OF BATTALIONS			
	ARVN	RGR	VNMC/ABN
QUANG TRI	6	0	0
THUA THIEN	11	0	0
QUANG NAM	5	1	0
QUANG TIN	3	2	0
QUANG NGAI	8	0	0

17-1

~~SECRET~~
UNCLASSIFIED

Unclassified

UNCLASSIFIED

SUMMARY OF MAJOR RVNAF OPERATIONS

OPERATION (DATE COMMENCED)	UNITS INVOLVED	LOCATION	CASUALTIES AS OF: 122400H FEB70		
			FRIENDLY		ENEMY
			KIA	WIA	KIA
LAM SON 350 (1JAN70)	2ND REGT: 1/2, 2/2, 3/2, 4/2 & 5/2	5 KM E OF GIO LINH	15	65	161
LAM SON 353 (1JAN70)	7TH CAV: 3/7 CAV	5 KM SE OF GIO LINH	6	34	14
LAM SON 354 (6JAN70)	54TH REGT: 3/54	6 KM S OF QUANG TRI CITY	1	1	1
LAM SON 352 (1JAN70)	54TH REGT: 1/54, 2/54 & 4/54	2 KM NW OF PHU BAI	1	7	20
LAM SON 349 (1JAN70)	1ST REGT: 1/1, 2/1, 3/1 & 4/1	21 KM NW OF A LUOI	8	45	119
LAM SON 351 (1JAN70)	3RD REGT: 1/3, 2/3, 3/3 & 4/3	25 KM SW OF HUE	5	22	31
HUNG QUANG 1/22 (12JAN70)	51ST REGT: 1/51	16 KM NW OF HOI AN	NONE	5	NONE
QUYET THANG 54 (2JAN70)	5TH REGT: 1/5, 2/5, 4/5 & 4/6	12 KM W OF TAM KY	20	53	132
DUONG SON 3/70 (11FEB70)	1ST ARM BDE: 37TH & 39TH RGR BNS & 3/17 ACAT	30 KM NW OF TAM KY	6	19	39
PHU DONG 401 (11FEB70)	2D BN 6TH REGT: 2/6, 1/4 & 2/4 ACAT	12 KM SW OF QUANG NGAI CITY	NONE	NONE	NONE
QUYET THANG 63 (2JAN70)	6TH REGT: 3/6	18 KM NW OF QUANG NGAI CITY	17	84	91
QUYET THANG 45 (4JAN70)	4TH REGT: 1/4, 2/4, 3/4 & 4/4	11 KM SW OF DUC PHO	17	47	227

ALL UNITS ARE ARVN UNLESS DESIGNATED
 * - ADJUSTED
 # - FINAL CUMULATIVE CASUALTIES

UNCLASSIFIED

Unclassified

UNCLASSIFIED

1969

1 CTZ RVNAF LARGE UNIT OFFENSIVE OPERATIONS

28 JANUARY 1970

OPERATION NAME	DATES	UNITS #	CASUALTIES						
			RVNAF		OTHER		VC/NVA		
			KIA	WIA	KIA	WIA	KIA	PW	WPNS
LAM SON 348	27OCT-31DEC69	2 BNs	17	42	0	0	137	4	53
DUONG SON 1/69	25OCT-8NOV69	3 BNs	3	7			36	20	0
HUNG QUANG 1/15	11NOV-7DEC69	3 BNs	1	9	0	0	0	0	0
DUONG SON 2/69	18NOV-29NOV69	2 BNs	10	57	0	0	44	0	0
DUONG SON 2/69 IIB	2DEC69-4DEC69	4 BNs	1	4			30	5	4
HUNG QUANG 1/18	8DEC69-11JAN70	2 BNs	5	15	0	0	0	0	0
HUNG QUANG 1/17	6DEC69-6JAN70	2 BNs	5	19	0	0	57	19	18

1970

1 CTZ RVNAF LARGE UNIT OFFENSIVE OPERATIONS

12 FEBRUARY 1970

OPERATION NAME	DATES	UNITS #	CASUALTIES						
			RVNAF		OTHER		VC/NVA		
			KIA	WIA	KIA	WIA	KIA	PW	WPNS
* LAM SON 349	1JAN-	4BNs							
* LAM SON 350	1JAN-	5 BNs							
* LAM SON 351	1JAN-	4 BNs							
* LAM SON 352	1JAN-	4 BNs							
* LAM SON 353	1JAN-	2 BNs							
PHU DONG 400	2JAN-5JAN70	2 BNs	2	1	0	0	0	0	0
QUYET THANG 404	2JAN-7JAN70	2 BNs	1	6	0	0	12	0	5
* QUYET THANG 54	2JAN-	3 BN							
* QUYET THANG 63	2JAN-	1 BN							
HUNG QUANG 1/19	4JAN-7JAN70	1 BN	1	3	0	0	12	0	9
* QUYET THANG 45	4JAN-	4 BNs							
VU NINH 9	7JAN-27JAN70	2 RNGR BNS	19	86	0	0	181	13	31
HUNG QUANG 1/21	9JAN-23JAN70	1BN	0	0	0	0	0	0	0
* LAM SON 354	6JAN-	1 BN							
* HUNG QUANG 1/22	12JAN-	2 BNs							
HUNG QUANG 1/22A	26JAN-30JAN70	1 BN	7	16	0	0	3	1	1
* HUNG QUANG 1/22B	31JAN-	1BN	1	2	0	0	0	1	0
* DUONG SON 3/70	11FEB-	2 RNGR BNS							
* PHU DONG 401	11FEB-	1BN							

ARVN UNLESS OTHERWISE INDICATED
 ☆ OPERATION CURRENTLY IN PROGRESS
 @ INDICATES LATE ENTRY
 § OPNS CONSOLIDATED INTO OPN LIEN KET-45 & CUMULATIVE CASUALTIES WILL BE CARRIED FORWARD.
 c OPNS CONSOLIDATED INTO OPN LIEN KET-63 & CUMULATIVE CASUALTIES WILL BE CARRIED FORWARD.
 * OPN LIEN KET-414 TERMINATED ON 28AUG69 & RECOMMENCED ON THE SAME DATE. CASUALTIES DURING INITIAL OPERATION WERE: RVNAF - 2 WIA; ENEMY - 19 KIA, 5 WPNS CPTD.

Unclassified

UNCLASSIFIED

~~SECRET~~
UNCLASSIFIED

MAJOR US AND FWMAF OPERATIONS IN PROGRESS

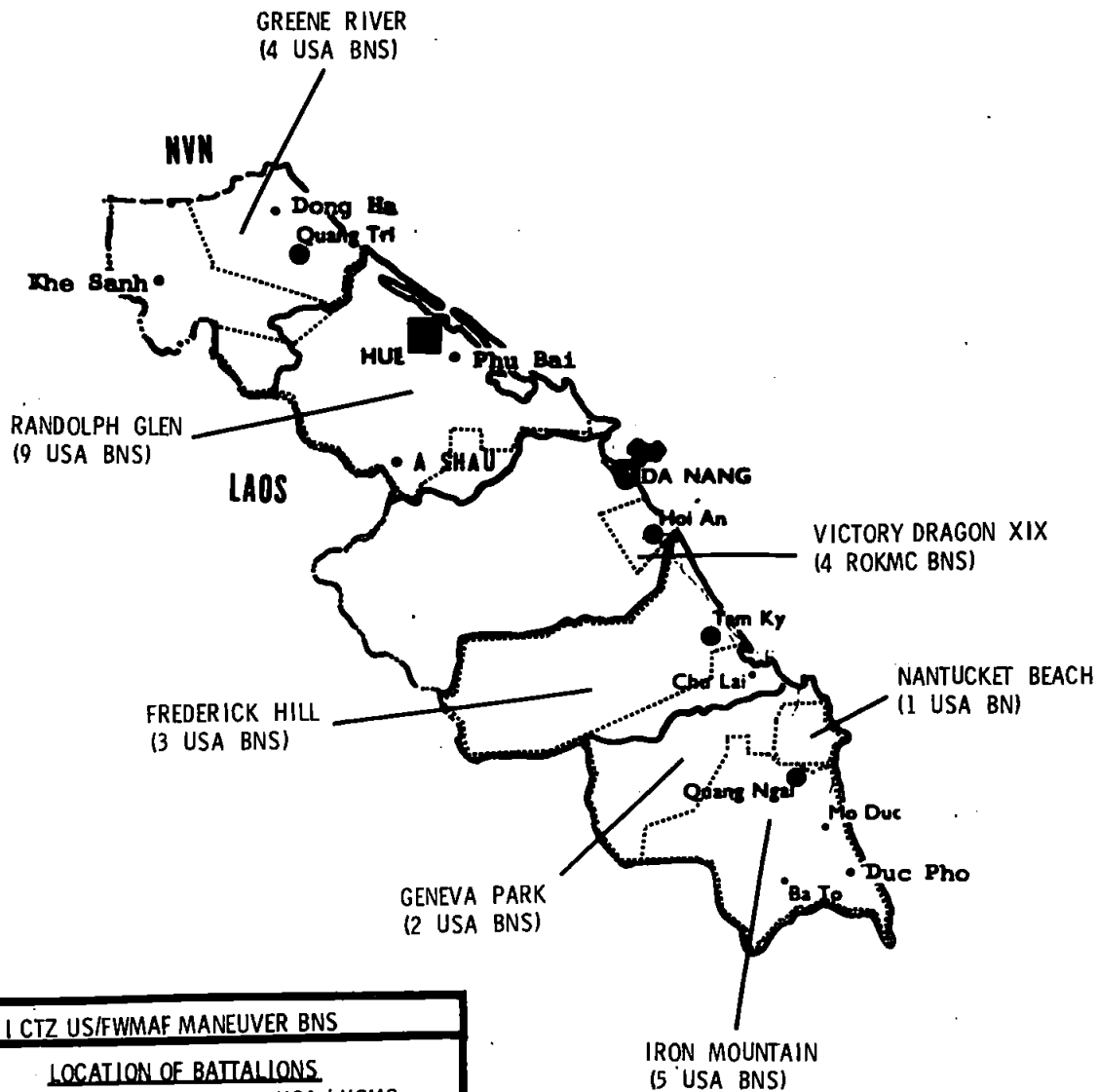

I CTZ US/FWMAF MANEUVER BNS		
LOCATION OF BATTALIONS	USA / USMC	
	QUANG TRI	4
THUA THIEN	9	0
QUANG NAM *	0	12
QUANG TIN	4	0
QUANG NGAI	8	0

* FOUR ROKMC BNS ALSO LOCATED IN QUANG NAM

19-1

~~SECRET~~
UNCLASSIFIED

UNCLASSIFIED

S [REDACTED]

SUMMARY OF MAJOR US AND FWMAF OPERATIONS

OPERATION (DATE COMMENCED)	UNITS INVOLVED	LOCATION	CASUALTIES AS OF: 122400H FEB70		
			FRIENDLY		ENEMY
			KIA	WIA	KIA
GREENE RIVER (19JAN70)	1ST BDE, 5TH INF DIV (MECH); 4 USA BNS	EASTERN QUANG TRI PROVINCE	4	46	90
RANDOLPH GLEN (7DEC69)	101ST ABN DIV (AM); 9 USA BNS	QUANG TRI & THUA THIEN PROVINCES	55	255	380
VICTORY DRAGON XIX (1JAN70)	2D ROKMC BDE; 4 ROKMC BNS	HOI AN AREA	1	11	9
FREDERICK HILL (18MAR69)	196TH INF BDE; 3 USA BNS	QUANG TIN PROVINCE	369	2,323	4,451
GENEVA PARK (18JUL69)	198TH INF BDE; 2 USA BNS	QUANG TIN & QUANG NGAI PROVINCES	125	855	1,126
NANTUCKET BEACH (20JUL69)	198TH INF BDE; 1 USA BN	CENTERED 15 KM NE OF QUANG NGAI CITY	24	208	247
IRON MOUNTAIN (18MAR69)	11TH INF BDE; 5 USA BNS	QUANG NGAI PROVINCE	287	1,647	2,487

* - ADJUSTED
- FINAL CUMULATIVE CASUALTIES

UNCLASSIFIED

Unclassified

UNCLASSIFIED

1970

III MAF LARGE UNIT OFFENSIVE OPERATIONS 12 FEBRUARY 1970

OPERATION NAME	DATES	UNITS#	CASUALTIES						
			USMC		OTHER		KIA	VC/NVA PW	WPNS
			KIA	WIA	KIA	WIA			
★ VICTORY DRAGON XIX	1JAN-	2 ROKMC Bns							
VICTORY DRAGON XIX-31	11JAN-17JAN70	1 ROKMC BN	0	0	0	0	40	0	18
★ GREEN RIVER	19JAN-	4 USA Bns							
VICTORY DRAGON XIX-1	25JAN-4FEB70	1 ROKMC BN	0	0	0	8	40	0	0
VICTORY DRAGON XIX-21	31JAN-10FEB70	1 ROKMC	0	0	1	3	1	0	0
VICTORY DRAGON XIX-31	4FEB70-11FEB70	1 ROKMC BN	0	0	0	1	1	0	0

USMC UNLESS OTHERWISE INDICATED
★ OPERATION CURRENTLY IN PROGRESS

LARGE UNIT OPERATIONS SINCE 8 MARCH 1965

409

19-7

Unclassified

UNCLASSIFIED

UNCLASSIFIED

MARINE CORPS COMMAND CENTER

USMC/ENEMY CASUALTIES IN RVN

12 FEBRUARY 1970

USMC BATTLE CASUALTIES

KIA/DOW	WIA(EVAC)	WIA(RTD)	MIA/PW
12,447	48,807	35,778	83/21

USMC CASUALTY FIGURES ARE PROVIDED DAILY BY HQMC CASUALTY SECTION (CODE DNA) AND REFLECT ALL CASUALTIES REPORTED AS OF 10FEB70.

USMC NON-BATTLE CASUALTIES

DEAD	INJURED	MISSING
1,504	1,821	9

FIGURES INDICATED AS INJURED ARE ONLY THOSE IN SERIOUS/CRITICAL INJURY OR DISEASE CATEGORY AND DO NOT INCLUDE THOSE OF A MINOR NATURE

USMC INFLICTED ENEMY CASUALTIES

KIA	PW	WPNS
80,405	4,187	20,787

ENEMY CASUALTIES ARE COMPILED DAILY FROM THE III MAF HISSUM AND ARE RECONCILED MONTHLY WITH THE FMFPAC SUMMARY OF USMC OPERATIONS IN RVN

TYPICAL DISPOSITION OF 100 USMC WIA *

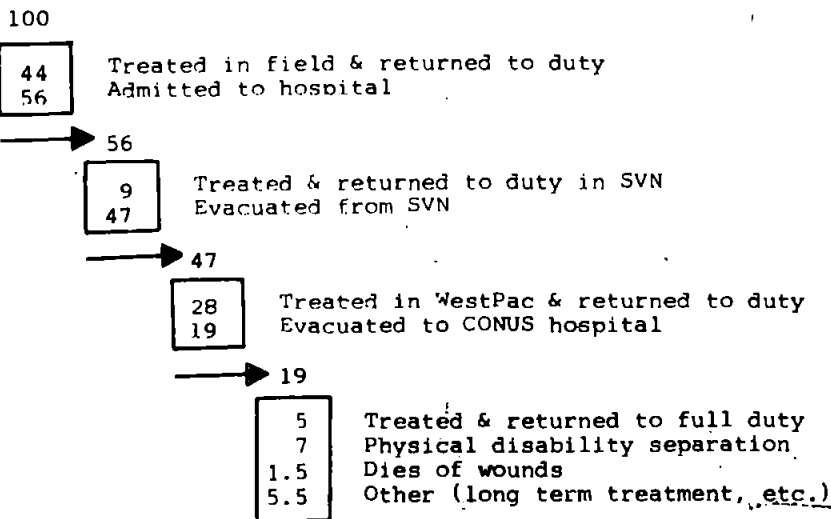

*54,081 CASUALTIES, JAN67-DEC68.

UNCLASSIFIED

UNCLASSIFIED

~~CONFIDENTIAL~~

MARINE CORPS COMMAND CENTER

MILITARY FORCES IN RVN *

12 FEBRUARY 1970

RVN ARMED FORCES (RVNAF)

ARMY (ARVN)	416,278
NAVY (VNN)	30,143
AIR FORCE (VNAF)	36,469
MARINE CORPS (VNMC)	11,528
REGIONAL FORCES (RF)	260,455
POPULAR FORCES (PF)	214,383
TOTAL RVNAF	969,256

UNITED STATES FORCES

ARMY	332,158
NAVY	29,526
AIR FORCE	57,087
MARINE CORPS	52,936
COAST GUARD	375
TOTAL U.S.	472,092

FREE WORLD MILITARY ASSISTANCE FORCES (FWMAF)

REPUBLIC OF KOREA	48,893
AUSTRALIA	7,692
PHILIPPINES	142
THAILAND	11,566
NEW ZEALAND	556
REPUBLIC OF CHINA	28
SPAIN	10
TOTAL FWMAF	68,887

TOTAL FORCES IN RVN 1,510,225

SOURCE: RVNAF MACV MONTHLY GIVEN FORCES STRENGTH DATA REPORT.

ALL OTHER, MACV WEEKLY STRENGTH REPORT AS OF 2400, 5FEB70. USMC STRENGTH: MACV WK STRENGTH REPORT AND AS ADJUSTED BY MACV RPT OF ARR/DEP AS OF 2400, 10FEB70.

UNCLASSIFIED
Unclassified
~~CONFIDENTIAL~~

MARINE CORPS COMMAND CENTER

SELECTED PERSONNEL AND AIRCRAFT DATA

PERSONNEL

13 FEBRUARY 1970

	STRENGTH	PERCENT USMC	PERCENT FMF	PERCENT FMFPAC
USMC TOTAL	300,982 *	100.00		
FLEET MARINE FORCES	153,729	51.08	100.00	
FMF ATLANTIC	45,696 \$	15.18	29.73	
FMF PACIFIC	108,033 #	35.90	70.27	
VIETNAM	52,661 †	17.60	34.46	49.04

SOURCE: * MONTHLY USMC PERSONNEL ALLOCATION REPORT OF 30NOV69.
 \$ MCCC UNIT REPORT OF 4FEB70.
 # MCCC UNIT REPORT OF 21JAN70.
 † MACV WEEKLY STRENGTH REPORT AS OF 2400, 5FEB70 AS ADJUSTED BY THE MACV DAILY RPT OF ARR/DEP AS OF 2400, 11FEB70.

AIRCRAFT

5 FEBRUARY 1970

	FIXW	HELO	TOTAL	PERCENT USMC	PERCENT FMF	PERCENT FMFPAC
USMC TOTALS	1013	569	1582	100.00		
FLEET MARINE FORCES	763	543	1306	82.55	100.00	
FMF ATLANTIC	303	156	459	29.01	35.15	
FMF PACIFIC	460	387	847	53.54	64.85	
VIETNAM	156	178	334	21.11	25.57	39.43

SOURCE: MARINE CORPS COMMAND CENTER UNIT REPORT OF 31DEC69.

UNCLASSIFIED
 Unclassified

UNCLASSIFIED

FLEET MARINE FORCE DEPLOYMENTS

13 FEBRUARY 1970

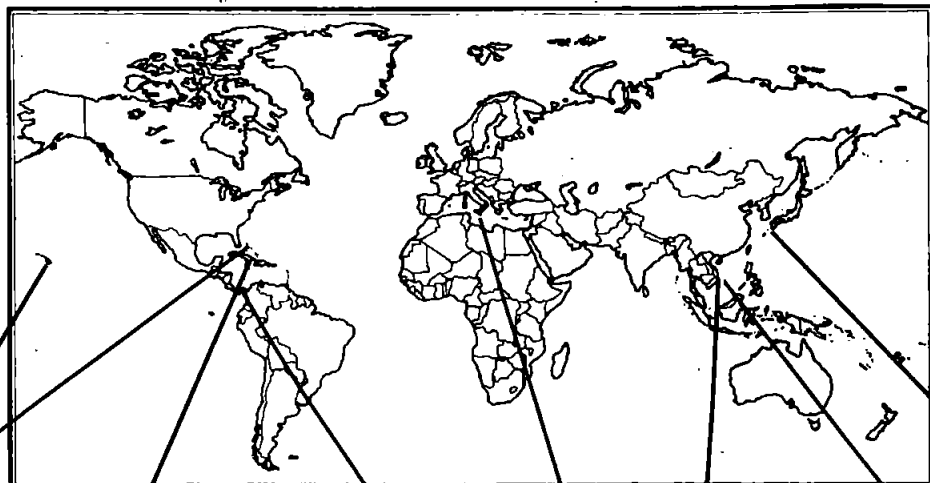

1ST MAR BRIG
HAWAII

DET HJBN 10TH MAR
DET 1/10
DET 2/10
DET 3/10
DET 4/10
DET 2D FAG
DET 1, HMM 264
ENR VIEQUES FOR FIREX

GTMO AUGMENT

2D BN, 8TH MAR
BTRY B/1/10
PLT 2D TK BN
PLT 2D ANGLICO
DET FSR

LANFORCARIB 1-70

BLT 3/2 & HMM-261
AT CRISTOBAL

LANFOR6THFLT 3-69

AT NAVPLION
GREECE

III MAF

RVN

SLF, 7TH FLEET

SLF BRAVO
AT TAIWAN

I MEF

OKINAWA
& JAPAN

DET 12TH MAR "D" CO,
3D RECON BN AT FUJI
FOR TRNG.

SLF ALFA
AT OKINAWA

DISTRIBUTION OF MAJOR FMF UNITS

	INF BNS	VMFA	VMA	VMA(AW)	VMCJ	HMM	HMR	HML	YMO	VMGR
WESTPAC	18	5	2	3	1	6	2	2	2	1
RVN	(12)	(3)	(2)	(2)	(1)	(4)	(1)	(2)	(1)	
OKINAWA/JAPAN	(4)	(2)		(1)			(1)		(1)	(1)
ASSIGNED TO SLF's	(2)					(2)				
MIDPAC	1	2								
HAWAII	(1)	(2)								
AFLOAT										
EASTPAC	2	* 3	2		1	2	2	1		1
WEST COAST	(2)	(3)	(2)		(1)	(2)	(2)	(1)		(1)
AFLOAT										
ATLANTIC	8	5	2	3	1	4	2		1	1
EAST COAST	(6)	(5)	(2)	(3)	(1)	(3)	(2)		(1)	(1)
CARIBBEAN	(2)					(1)				
EUROPE	1									
MEDITERRANEAN	(1)									
GRAND TOTAL	30	15	6	6	3	12	6	3	3	3

* CATRE

UNCLASSIFIED

MARINE CORPS COMMAND CENTER

UNCLASSIFIED

DISTRIBUTION OF PERSONNEL*

FLEET MARINE FORCE, PACIFIC

13 FEBRUARY 1970

UNIT	NOTE	ASSIGNED STRENGTH		STR RPT DATE	DANANG		CHU LAI		PHU BAI		No I CTZ		OKINAWA		JAPAN		HAWAII		EASTPAC		OTHER		
		USMC	USN		USMC	USN	USMC	USN	USMC	USN	USMC	USN	USMC	USN	USMC	USN	USMC	USN	USMC	USN	USMC	USN	USMC
HEADQUARTERS																							
HQ, FMF, PAC																							
H&S BN, FMF, PAC		1668		8FEB70													1668						
CAMP S. D. BUTLER CASUAL		559											559										
HOSPITALIZED	5	148											148										
HQ, V MEB		566																				566	
1ST CIVAFFGRP		74	4																		74	4	
H&S CO, 5TH MEB		1393	27																		1393	27	
HQ, FORTRPS, FMF PAC																							
HQCO, FORTRPS		239	26																		239	26	
HQ, 1ST MAR BRIG																							
HQCO, 1ST MAR BRIG		252	26															252	26				
I MEF																							
HQ 3RD MARDIV																							
HQBN 3RD MARDIV		1424	56										1424	56									
HQ III MAF																							
H&S CO III MAF		1122	29		1122	29																	
1ST CAG		538					538																
2D CAG		648			648																		
3D CAG		533							533														
4TH CAG		365									365												
HQ 1ST MARDIV																							
HQBN 1ST MARDIV		2415	39		2366	39																	49
INFANTRY																							
1ST MARINES																							
HQ CO		289	9		289	9																	
1ST BATTALION		1064	58		1064	58																	
2D BATTALION		1081	56		1081	56																	
3D BATTALION		1086	55		1086	55																	
3D MARINES																							
HQ CO		317	7																			317	7
1ST BATTALION		1438	78														1438	78			1009	59	
2D BATTALION		1009	59																		961	55	
3D BATTALION		961	55																				
4TH MARINES																							
HQ CO		183	7										183	7									
1ST BATTALION		979	52										979	52									
2D BATTALION		851	49										851	49									
3D BATTALION		861	52										861	52									
5TH MARINES																							
HQ CO		430	13		430	13																	
1ST BATTALION		1049	56		1049	56																	
2D BATTALION		1046	58		1046	58																	
3D BATTALION		1040	58		1040	58																	
7TH MARINES																							
HQ CO		329	12		329	12																	
1ST BATTALION		1013	56		1013	56																	
2D BATTALION		1058	53		1058	53																	
3D BATTALION		1074	49		1074	49																	
9TH MARINES																							
HQ CO		264	10										264	10									
1ST BATTALION		1459	81										1459	81									
2D BATTALION	1	1101	51																			1101	51
3D BATTALION		962	52										962	52									
26TH MARINES																							
HQ CO		304	6		304	6																	
1ST BATTALION		1062	57		1062	57																	
2D BATTALION		1080	58		1080	58																	
3D BATTALION		1090	56		1090	56																	
ARTILLERY																							
11TH MARINES																							
HQ BTRY		444	9		444	9																	
1ST BATTALION		598	17		598	17																	
2D BATTALION		584	16		584	16																	
3D BATTALION		642	16		642	16																	
4TH BATTALION		571	15		571	15																	
12TH MARINES																							
HQ BTRY		225	15										225	15									
1ST BATTALION		1095	21																		1095	21	
2D BATTALION		641	17										641	17									
3D BATTALION		563	15										563	15									
4TH BATTALION		362	15										362	15									

* UNLESS OTHERWISE NOTED, STRENGTHS AND LOCATION ARE THOSE REPORTED BY UNIT PERSONNEL STATUS REPORTS AND DO NOT REFLECT DAY-TO-DAY ADJUSTMENTS BETWEEN REPORTING PERIODS.

** UNLESS OTHERWISE NOTED STRENGTH REPORT DATE IS 12FEB70.

Unclassified

UNCLASSIFIED

~~CONFIDENTIAL~~
UNCLASSIFIED

DISTRIBUTION OF PERSONNEL

FLEET MARINE FORCE, PACIFIC

13 FEBRUARY 1970

UNIT	NOTE	ASSIGNED STRENGTH		LSTB RPT DATE	DANANG		CHU LAI		PHU BAI		No I CTZ		OKINAWA		JAPAN		HAWAII		EASTPAC		OTHER		
		USMC	USN		USMC	USN	USMC	USN	USMC	USN	USMC	USN	USMC	USN	USMC	USN	USMC	USN	USMC	USN	USMC	USN	USMC
1ST BN, 13TH MARINES		1143	31		1143	31																	
HO BTRY, 1ST FAG		294	9																294	9			
1ST 175MM GUN BTRY		151	3		151	3																	
3D 175MM GUN BTRY		172	3		172	3																	
5TH 175MM GUN BTRY		217	8							217	8												
7TH 155MM GUN BTRY		499	1																499	1			
1ST 8" HOW BTRY		207	5							207	5												
3D 8" HOW BTRY		216	5		216	5																	
RECONNAISSANCE																							
1ST RECON BN		740	53		740	53																	
3D RECON BN		380	23									288	18							92	5		
1ST FORCE RECON CO		149	7		149	7																	
3D FORCE RECON CO		152	7							152	7												
1ST SLT BTRY (CAJRE)																							
ANTI-TANK																							
1ST AT BN																							
3D AT BN	4																						
CO 'A' 3D ATBN		94	7																	94	7		
TANK																							
1ST TANK BN		708	21		708	21																	
3D TANK BN		653	19									456	12							197	7		
AMTRAC																							
1ST AMTRAC BN		715	16									497	12							218	4		
3D AMTRAC BN		768	21		768	21																	
1ST ARM AMPHIB CO		88																		88			
ENGINEER																							
1ST ENGR BN		790	17		790	17																	
3D ENGR BN		656	17									501	16							155	1		
7TH ENGR BN		1054	24		1054	24																	
9TH ENGR BN		1051	21				1051	21															
11TH ENGR BN		1014	14									439	12							575	2		
1ST BRIDGE CO		205	2		205	2																	
3D BRIDGE CO		141	1																	141	1		
MOTOR TRANSPORT																							
1ST MT BN		392	7		392	7																	
3D MT BN		258	10									182	9							76	1		
9TH MT BN		470	11									311	10							159	1		
11TH MT BN		514	8		514	8																	
COMMUNICATION																							
1ST RADIO BN		500	1		348							67						85	1				
5TH COMM BN		989	13		989	13																	
7TH COMM BN		365	9									365	9										
9TH COMM BN		1182	11																		1182	11	
1ST ANGLICO	2	250	7															110	4			140	3
SHORE PARTY																							
1ST SP BN		513	20		513	20																	
3D SP BN		514	28									381	12							133	16		
MILITARY POLICE																							
1ST MP BN		656	16		656	16																	
3D MP BN		794	14		794	14																	
SERVICE/SUPPORT																							
FLC, III MAF																							
HQ, FLC/1ST FSR																							
H&S BN	7	2026	56		1375	56														651			
SUPPLY BN		1605	38		1605	38																	
7TH SEP BK FUEL CO		242			242																		
MAINT BN		1150	12		1150	12																	
FLSG-B/1ST SERV BN		2515	39		2515	39																	
3D FSR																							
H&S BN		897	34									897	34										
SUPPLY BN		1078	22									1078	22										
MAINT BN		884										884											
5TH FSR																							
H&S BN		613	24																	613	24		
SUPPLY BN		685	16																	685	16		
MAINT BN		821																		821			
3D SERV BN (-)		1511	45									600	27							911	18		
9TH SEP BULK FUEL CO		356																		356			

Unclassified

UNCLASSIFIED

UNCLASSIFIED

DISTRIBUTION OF PERSONNEL

FLEET MARINE FORCE, PACIFIC

13 FEBRUARY 1970

UNIT	NOTE	ASSIGNED STRENGTH		STRENGTH RPT. DATE	DANANG		CHU LAI		PHU BAI		No I CTZ		OKINAWA		JAPAN		HAWAII		EASTPAC		OTHER		
		USMC	USN		USMC	USN	USMC	USN	USMC	USN	USMC	USN	USMC	USN	USMC	USN	USMC	USN	USMC	USN	USMC	USN	USMC
1ST BRIG																							
MAG-24																							
H&MS-24		455															455						
M&BS-24		349	27														349	27					
MACS-2		200															200						
MATCU-70		40															40						
VMFA-212		278															278						
VMFA-235		266															266						
3D MAW																							
MWHG-3																							
H&HS-3		671	99															671	99				
MWFS-3		174																174					
MWCS-3		265																265					
MCCRTG-10																							
H&MS-10		279	2																279	2			
VMAT-102		208																	208				
VMT-103		190																	190				
MHTG-30																							
H&MS-30		358	1																358	1			
HMHT-301		164	1																164	1			
HMMT-302		191	1																191	1			
MAG-33																							
H&MS-33		926	1																926	1			
M&BS-33		533	3																533	3			
MATCU-65		61																	61				
VMCJ-3		371	1																371	1			
VMA-223	7	166	1																166	1			
VMA-214		218																	218				
VMFA-531		380	1																380	1			
VMFA-542	7	269	1																269	1			
VMFA-323 (CADRE)		12																	12				
VMFAT-101		511																	511				
MWSG-37																							
H&MS-37		663	3																663	3			
WERS-37		308	1																308	1			
VMGR-352		371	1																371	1			
M&CG-38																							
H&HS-38		312	2																312	2			
MACS-1		301																	301				
MACS-3		269	4																269	4			
MACS-7		284	1																284	1			
1ST LAAM BN		144																	144				
2ND LAAM BN		764	18																764	18			
MAG-56																							
H&MS-56		483																	483				
M&BS-56		467	2																467	2			
MATCU-74		81																	81				
HMM-163		255	1																255	1			
HML-267		383	5																383	5			
HMM-265		215	1																215	1			
HMH-363		274																	274				
MATCU-75		48																	48				
HMH-361	7	185																	185				
USMC		30,998			8,068	3,155		0	0	2,434	3,752	1,649	11,754	186									
USN		458			135	55		0	0	48	27	27	152	3									
AVIATION TOTAL		31,456			8,203	3,221		0	0	2,482	3,779	1,676	11,906	189									

RECAPITULATION OF FMFPAC PERSONNEL DISTRIBUTION

		ASSIGNED STRENGTH	DANANG	CHU LAI	PHU BAI	No I CTZ	OKINAWA	JAPAN	HAWAII	EASTPAC	OTHER
GROUND TOTAL	USMC	76,601	38,481	1,569	685	789	16,523	0	3,553	13,145	1,856
	USN	3,431	1,824	21	7	13	889	0	109	514	54
AVIATION TOTAL	USMC	30,998	8,068	3,155	0	0	2,434	3,752	1,649	11,754	186
	USN	458	135	66	0	0	48	27	27	152	3
GRAND TOTAL	USMC	107,599	46,549	4,724	685	789	18,957	3,752	5,202	24,899	2,042
	USN	3,889	1,959	87	7	13	937	27	136	666	57

- NOTES:
- FIGURES IN "OTHER" ASSIGNED TO SLP'S.
 - FIGURES IN "OTHER" ASSIGNED TO VARIOUS LOCATIONS IN RVN.
 - PERSONNEL IN "OTHER" ARE ASSIGNED TO IT, IIT, SSC, CIT, RED EYE AND NUCLEAR ORINANCE PLATOONS.
 - STRENGTH INCLUDED IN 1ST AND 3D TANK BATTALIONS.
 - THE 559 PERSONNEL LISTED IN "OTHER" ARE HOSPITALIZED AT LOCATIONS OTHER THAN OKINAWA, BUT ARE CARRIED ON THE ROLLS OF CASUAL COMPANY, MCB, CAMP BUTLER.
 - AT SUBIC
 - ENROUTE EASTPAC.
 - PERSONNEL ARE NON-FMF CARRIED FOR OSD PROGRAM STRENGTH TOTALS ONLY.
 - UNLESS OTHERWISE NOTED, STRENGTHS AND LOCATION ARE THOSE REPORTED BY UNIT PERSONNEL STATUS REPORTS AND DO NOT REFLECT DAY-TO-DAY ADJUSTMENTS BETWEEN PERIODS.
 - UNLESS OTHERWISE NOTED STRENGTH REPORT DATE IS 12FEB70.

UNCLASSIFIED

UNCLASSIFIED

~~SECRET~~

UNCLASSIFIED

MARINE CORPS COMMAND CENTER

MARINE CORPS PERSONNEL IN RVN

13 FEBRUARY 1970

	OFF	ENL	TOTAL
* III MAF	3,506	48,844	52,350
DANANG	(3,006)	(42,409)	(45,415)
CHU LAI	(388)	(4,851)	(5,239)
PHU BAI	(77)	(880)	(957)
DONG HA	(35)	(704)	(739)
SU #1, 1ST ANGLICO (AT VARIOUS LOCATIONS SVN)	((21))	((191))	((212))
OTHER USMC PERSONNEL	159	152	311
MACV STAFF/MACV FIELD	(136)	(139)	(275)
NAVAVGRU/NAVY UNITS	(23)	(13)	(36)
USMC IN RVN CHARGED AGAINST PROGRAM VIII	3,665	48,996	52,661
U. S. NAVY, III MAF.	259	1,839	2,098

* AS REPORTED BY III MAF DAILY ADMIN SITREP # 038 AS OF 2400, 6FEB70 AND THE MACV WEEKLY STRENGTH REPORT, AS OF 2400, 5FEB70 AS ADJUSTED BY MACV DAILY RPT OF ARR/DEP AS OF 2400, 11FEB70.

Unclassified

UNCLASSIFIED

~~SECRET~~

WESTPAC UNIT LOCATIONS

13 FEBRUARY 1970

QUANG TRI

(QUANG TRI)

1ST BDE, 5TH INF DIV (MECH)
 1/77 ARMOR (OPN GREENE RIVER)
 1/61 INF (MECH) (OPN GREENE RIVER)
 1/11 INF (OPN GREENE RIVER)
 3/5 ARMD CAV SQDN (OPN GREENE RIVER)

USMC 739
 USN 38
 USA 5,808

THUA THIEN

HO, XXIV CORPS (PHU BAI)

HO, 101st ABN DIV (AM)

1ST BDE, 101ST ABN DIV (AM)
 1/327 INF (AM) (OPN RANDOLPH GLEN)
 2/327 INF (AM) (OPN RANDOLPH GLEN)
 2/502 INF (AM) (OPN RANDOLPH GLEN)

2D BDE, 101ST ABN DIV (AM)
 1/501 INF (AM) (OPN RANDOLPH GLEN)
 2/501 INF (AM) (OPN RANDOLPH GLEN)
 1/502 INF (AM) (OPN RANDOLPH GLEN)

3D BDE, 101ST ABN DIV (AM)
 1/506 INF (AM) (OPN RANDOLPH GLEN)
 2/506 INF (AM) (OPN RANDOLPH GLEN)
 3/187 INF (AM) (OPN RANDOLPH GLEN)

1st MAW
 MAG-16
 HML-367 (UH-1E)

USMC 957
 USN 47
 USA 26,177

QUANG NAM

HQS 1ST MAR DIV (DANANG)

1ST MARINES
 1/1
 2/1
 3/1

5TH MARINES
 1/5
 2/5
 3/5

7TH MARINES
 1/7
 2/7
 3/7

26TH MARINES
 1/26
 2/26
 3/26

HQS, III MAF

HO 1st MAW
 MAG-11

VMA(AW)-242 (A-6A)
 VMA(AW)-225 (A-6A)
 VMJC-1 (RF-4/EA-6/EF-10)
 VMO-2 (AH-1G/OV-10A)

MAG-16 (-)
 HML-167 (UH-1E)
 HMM-463 (CH-53A)
 HMM-364 (CH-46D)
 HMM-263 (CH-46D)
 HMM-262 (CH-46D)
 HMM-161 (CH-46D)

2d ROKMC BDE

1/2 (OPN VICTORY DRAGON XIX)
 2/2 (OPN VICTORY DRAGON XIX)
 3/2 (OPN VICTORY DRAGON XIX)
 5/2 (OPN VICTORY DRAGON XIX)

USMC 45,415
 USN 1,889
 USA 1,090
 ROKMC 7,145

FLC 1ST FSR/FLSG-B/1ST SERV BN

QUANG TIN/QUANG NGAI

HO 23d INF DIV (AMERICAN) (CHU LAI)

196TH LT INF BDE
 2/1 INF (OPN FREDERICK HILL)
 4/31 INF (OPN FREDERICK HILL)
 3/21 INF (OPN FREDERICK HILL)
 1/46 INF

198TH LT INF BDE
 1/6 INF (OPN GENEVA PARK)
 1/52 INF (OPN GENEVA PARK)
 5/46 INF (OPN NANTUCKET BEACH)

11TH INF BDE
 1/20 INF (OPN IRON MOUNTAIN)
 4/21 INF (OPN IRON MOUNTAIN)
 3/1 INF (OPN IRON MOUNTAIN)
 4/3 INF (OPN IRON MOUNTAIN)
 1/1 ARMD CAV SQDN (OPN IRON MOUNTAIN)

1st MAW

MAG-12 (A-4E)
 VMA-211 (A-4E)
 VMA-311 (A-4E)

MAG-13
 VMFA-115 (F-4B)
 VMFA-314 (F-4B)
 VMFA-122 (F-4B)

USMC 5,239
 USN 124
 USA 24,331

OKINAWA

HO, I MEF
 3D MAR DIV (-) (REIN)(TF-79)
 11th MEB (TF-79.1)

4TH MARINES
 1/4
 2/4
 3/4

9TH MARINES
 3/9

MAG-36 (14,061)
 VMGR-152 (KC-130F)
 VMO-6 (OV-10A/UH-1E)
 HMM-462 (CH-53A)

3D FSR (3,456) (50)
 MCB CAMP BUTLER/NON FMF (915) (25)
 Non-Deployable Casuals (148)
 SVN-Originated Patients (0)

OSD PROGRAM VIII CEILING 19,200 934
 ACTUALS CHARGED AGAINST PROGRAM VIII AS OF 5FEB70 18,580 424

USMC USN

USMC RVN RECAP

OSD PROGRAM VIII CEILING 55,510 2,233
 ACTUALS CHARGED AGAINST PROGRAM VIII AS OF 11FEB70 52,661 2,098
 III MAF 52,350 2,098
 SU#1 1ST ANGLICO (212) (14)
 OTHER 311
 MACV STAFF/MACV FIELD (275)
 NAVAVGRU/NAVY UNITS (36)

I CORPS RECAP

US MARINE CORPS (12 BNs) 52,350
 US ARMY (25 BNs) 73,849
 US NAVY 17,012
 US AIR FORCE 8,194
 ROKMC (4 BNs) 6,148
 RVNAF (36 BNs) 153,895
 ARVN/ABN (36 BNs) (74,634)
 VNMC
 VNN (2,100)
 VNAP (3,408)
 VNRF (37,403)
 VNPF (36,350)

I CORPS TOTAL 77 BNs 311,448

SLF 7TH FLEET

BRavo: BLT 2/9 1,847 60
 HMM-165
 AT TAIWAN
 ALFA: BLT 1/9 1,868 85
 HMM-164
 AT OKINAWA

MOVEMENTS

Det 12th Mar and "D" Co, 3d Recon Bn, At Fuji for training.

JAPAN

OSD PROGRAM VIII CEILING 3,600 45
 ACTUALS CHARGED AGAINST PROGRAM VIII AS OF 5FEB70 3,749 34

1ST MAW (REAR)

MAG-15 (2,553) (34)
 VMFA-232 (F-4J)
 VMFA-334 (F-4J)
 VMA(AW)-533 (A-6A)

*Does NOT include 243 hospitalized SVN-Originated Patients.

Non FMF (1,196)

* Includes only U. S. Navy Personnel organic to FMF Units.
 # Includes SU#1 and 1st ANGLICO at various locations throughout SVN.
 • Latest Change

Unclassified

UNCLASSIFIED

MARINE CORPS

FEB 13 1970

REFERENCE BRANCH

Unclassified

UNCLASSIFIED

MAJOR RVNAF OPERATIONS IN PROGRESS

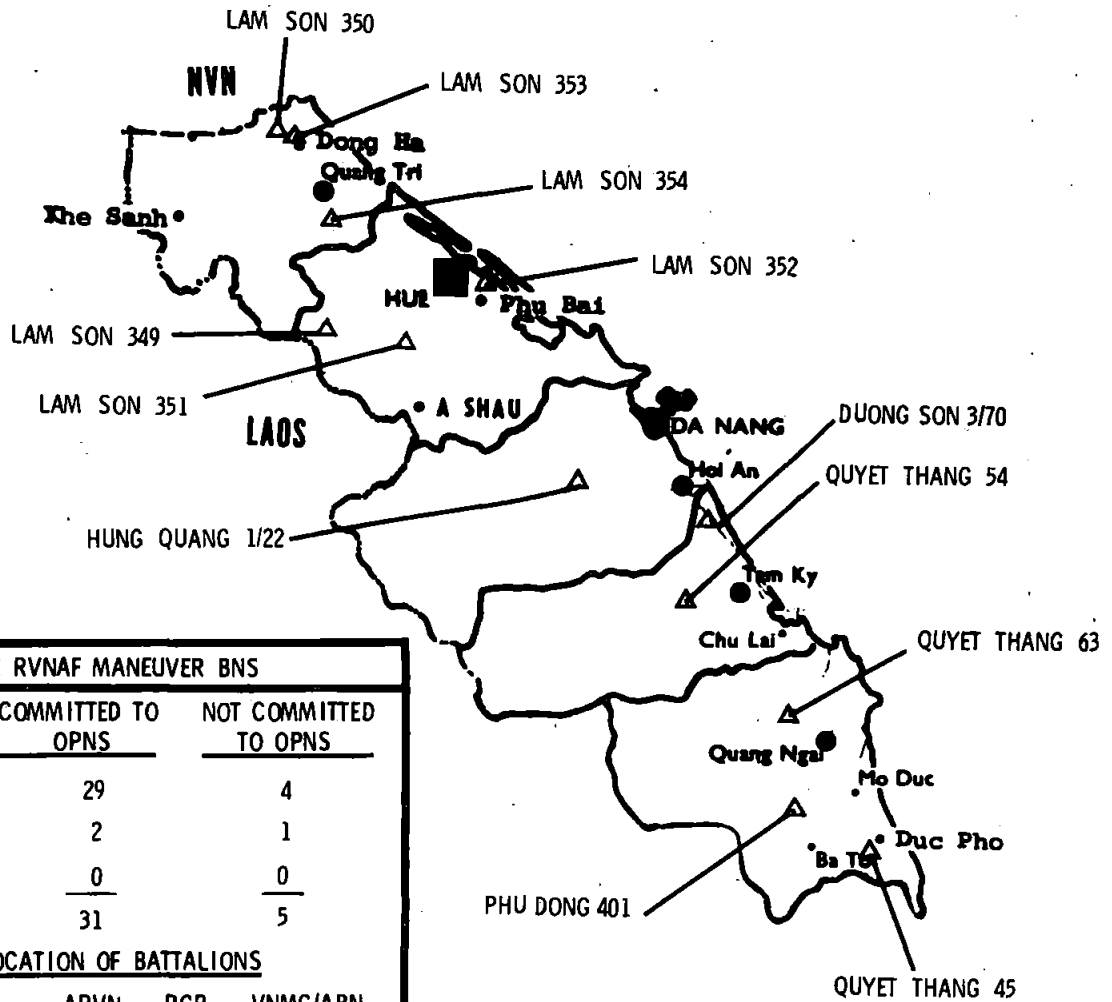

I CTZ RVNAF MANEUVER BNS			
TOTAL BNS	COMMITTED TO OPNS		NOT COMMITTED TO OPNS
ARVN	33	29	4
RANGER	3	2	1
VNMC/ABN	0	0	0
	36	31	5
LOCATION OF BATTALIONS			
	ARVN	RGR	VNMC/ABN
QUANG TRI	6	0	0
THUA THIEN	11	0	0
QUANG NAM	5	1	0
QUANG TIN	3	2	0
QUANG NGAI	8	0	0

~~SECRET~~

UNCLASSIFIED

UNCLASSIFIED

SUMMARY OF MAJOR RVNAF OPERATIONS

OPERATION (DATE COMMENCED)	UNITS INVOLVED	LOCATION	CASUALTIES AS OF: 132400H FEB70		
			FRIENDLY		ENEMY
			KIA	WIA	KIA
LAM SON 350 (1JAN70)	2ND REGT: 1/2, 2/2, 3/2, 4/2 & 5/2	5 KM E OF GIO LINH	15	66	174
LAM SON 353 (1JAN70)	7TH CAV: 3/7 CAV	5 KM SE OF GIO LINH	6	34	14
LAM SON 354 (6JAN70)	54TH REGT: 3/54	6 KM S OF QUANG TRI CITY	1	1	1
LAM SON 352 (1JAN70)	54TH REGT: 1/54, 2/54 & 4/54	2 KM NW OF PHU BAI	1	7	20
LAM SON 349 (1JAN70)	1ST REGT: 1/1, 2/1, 3/1 & 4/1	21 KM NW OF A LUOI	9	59	119
LAM SON 351 (1JAN70)	3RD REGT: 1/3, 2/3, 3/3 & 4/3	25 KM SW OF HUE	5	22	31
HUNG QUANG 1/22 (12JAN70)	51ST REGT: 1/51	16 KM NW OF HOI AN	NONE	5	NONE
QUYET THANG 54 (2JAN70)	5TH REGT: 1/5, 2/5, 4/5 & 4/6	12 KM W OF TAM KY	20	53	132
DUONG SON 3/70 (11FEB70)	1ST ARM BDE: 37TH & 39TH RGR BNS & 3/17 ACAT	30 KM NW OF TAM KY	7	23	39
PHU DONG 401 (11FEB70)	2D BN 6TH REGT: 2/6, 1/4 & 2/4 ACAT	12 KM SW OF QUANG NGAI CITY	NONE	NONE	NONE
QUYET THANG 63 (2JAN70)	6TH REGT: 1/6 & 3/6	18 KM NW OF QUANG NGAI CITY	19	95	97
QUYET THANG 45 (4JAN70)	4TH REGT: 1/4, 2/4, 3/4 & 4/4	11 KM SW OF DUC PHO	17	47	227

ALL UNITS ARE ARVN UNLESS DESIGNATED
 * - ADJUSTED
 # - FINAL CUMULATIVE CASUALTIES

UNCLASSIFIED

Unclassified

UNCLASSIFIED

SUMMARY OF MAJOR US AND FWMAF OPERATIONS

OPERATION (DATE COMMENCED)	UNITS INVOLVED	LOCATION	CASUALTIES AS OF: 132400H FEB70		
			FRIENDLY		ENEMY
			KIA	WIA	KIA.
GREENE RIVER (19JAN70)	1ST BDE, 5TH INF DIV (MECH); 4 USA BNS	EASTERN QUANG TRI PROVINCE	4	102	53
RANDOLPH GLEN (7DEC69)	101ST ABN DIV (AM); 9 USA BNS	QUANG TRI & THUA THIEN PROVINCES	55	255	380
VICTORY DRAGON XIX (1JAN70)	2D ROKMC BDE; 4 ROKMC BNS	HOI AN AREA	1	12	9
FREDERICK HILL (18MAR69)	196TH INF BDE: 3 USA BNS	QUANG TIN PROVINCE	369	2,326	4,461
GENEVA PARK (18JUL69)	198TH INF BDE: 2 USA BNS	QUANG TIN & QUANG NGAI PROVINCES	125	855	1,133
NANTUCKET BEACH (20JUL69)	198TH INF BDE: 1 USA BN	CENTERED 15 KM NE OF QUANG NGAI CITY	24	*212	247
IRON MOUNTAIN (18MAR69)	11TH INF BDE: 5 USA BNS	QUANG NGAI PROVINCE	288	1,652	2,489

* - ADJUSTED
- FINAL CUMULATIVE CASUALTIES

UNCLASSIFIED

Unclassified

Department of Defense

13 FEBRUARY 1970

NUMBER OF CASUALTIES INCURRED BY U. S. MILITARY PERSONNEL
IN CONNECTION WITH THE CONFLICT IN VIET-NAM

Cumulative from January 1, 1961 through February 7, 1970

	Army	Navy **	Marine Corps	Air Force	Total
A. CASUALTIES RESULTING FROM ACTIONS BY HOSTILE FORCES					
1. Killed	21,615	975	11,074	401	34,065
2. Wounded or Injured					
a. Died of wounds	2,935	129	1,352	38	4,454
b. Nonfatal wounds					
Hospital care required	81,548	3,638	48,787	669	134,642
Hospital care not required	88,819	5,268	35,766	2,090	131,943
3. Missing					
a. Died while missing	1,417	176	5	332	1,930
b. Returned to control	56	7	6	25	94
c. Current missing	185	112	83	546	926
4. Captured or Interned					
a. Died while captured or interned	13	-	3	1	17
b. Returned to control	37	3	4	6	50
c. Current captured or interned	54	142	21	213	430
5. Deaths					
a. From aircraft accidents/incidents					
Fixed Wing	73	154	132	603	962
Helicopter	1,476	54	370	41	1,941
b. From ground action	<u>24,431</u>	<u>1,072</u>	<u>11,932</u>	<u>128</u>	<u>37,563</u>
TOTAL DEATHS a/	25,980	1,280	12,434	772	40,466
B. CASUALTIES NOT THE RESULT OF ACTIONS BY HOSTILE FORCES					
6. Current Missing	117	-	9	-	126
7. Deaths					
a. From aircraft accidents/incidents					
Fixed Wing	218	122	44	225	609
Helicopter	1,236	26	216	8	1,486
b. From other causes	<u>3,312</u>	<u>540</u>	<u>1,239</u>	<u>210</u>	<u>5,301</u>
TOTAL DEATHS	4,766	688	1,499	443	7,396

a/ Sum of lines 1, 2a, 3a and 4a.

**Navy figures include a small number of Coast Guard casualties.

Directorate for Statistical Services
Office of the Secretary of Defense
February 11, 1970

Unclassified

UNCLASSIFIED

SECRET ONLY

MARINE CORPS COMMAND CENTER

USMC/ENEMY CASUALTIES IN RVN

13 FEBRUARY 1970

USMC BATTLE CASUALTIES

KIA/DOW	WIA(EVAC)	WIA(RTD)	MIA/PW
12,448	48,817	35,785	80/21

USMC CASUALTY FIGURES ARE PROVIDED DAILY BY HOMC CASUALTY SECTION (CODE DNA) AND REFLECT ALL CASUALTIES REPORTED AS OF 11FEB70.

USMC NON-BATTLE CASUALTIES

DEAD	INJURED	MISSING
1,504	1,821	12

FIGURES INDICATED AS INJURED ARE ONLY THOSE IN SERIOUS/CRITICAL INJURY OR DISEASE CATEGORY AND DO NOT INCLUDE THOSE OF A MINOR NATURE

USMC INFLECTED ENEMY CASUALTIES

KIA	PW	WPNS
80,457	4,189	20,797

ENEMY CASUALTIES ARE COMPILED DAILY FROM THE III MAF HISSUM AND ARE RECONCILED MONTHLY WITH THE FMFPAC SUMMARY OF USMC OPERATIONS IN RVN

TYPICAL DISPOSITION OF 100 USMC WIA *

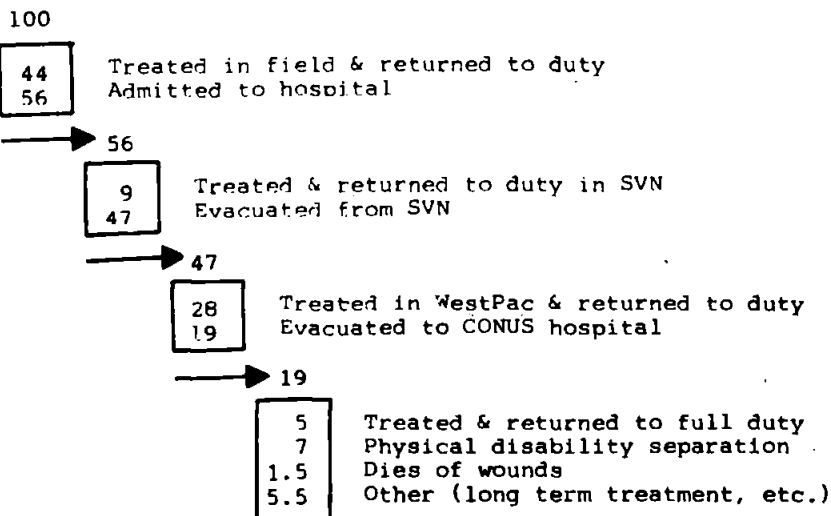

*54,081 CASUALTIES, JAN67-DEC68.

UNCLASSIFIED

Unclassified

~~CONFIDENTIAL~~

MARINE CORPS COMMAND CENTER

UNCLASSIFIED

SPECIAL LANDING FORCE, 7TH FLEET

SLF BRAVO

13 FEBRUARY 1970

TASK GROUP 79.4 CTG: COL G. G. CHAMBERS JR	STRENGTH				ARMS & EQUIPMENT	LOCATION				
	USMC		USN							
UNITS EMBARKED	OFF	ENL	OFF	ENL						
SLF HOS DET					8 M29 81MM MORTARS 3 M40 106MM RR 6 M30 107MM MORTARS 4 M101A1 105MM HOW 4 M48 90MM TANKS 5 LVTP-5	AT TAIWAN				
BLT 2/9 (LTCOL J. R. VANDENELZEN) 2D BN, 9TH MARINES W/2/12 E/2/12 PLAT, CO "B", 1ST AMTRAC PLAT, CO "C", 3D ENGR BN PLAT, CO "C", 3D SP BN PLAT, CO "C", 3D MT BN PLAT, CO "C", 3D RECON BN PLAT, CO "A", 3D TK BN CLEAR PLAT, CO "B", 3D MED SQD, MP CO, 3D MARDIV DET, HQBN, 3D MARDIV DET, COMM PLT, HQCO, 9TH MAR DET, COMM SPT CO, 7TH COMM DET, 3D DENTAL CO LSU	52	1500	1	56				SHIPPING USS NEW ORLEANS (LPH-11) USS THOMASTON (LSD-28) USS VANCOUVER (LPD-2) USS WHITFIELD CTY (LST-1169)		
HMM-165 (LTCOL P. H. MITCHELL)	69	226	1	2					SUPPLIES CLASS I CLASS II CLASS III CLASS IV CLASS V	
TOTALS	121	1726	2	58			AIRCRAFT 18/CH-46A			

SLF ALFA

28 JANUARY 1970

TASK GROUP 79.5 CTG: COL C. W. BOYD, JR.	STRENGTH				ARMS & EQUIPMENT	LOCATION				
	USMC		USN							
UNITS EMBARKED	OFF	ENL	OFF	ENL						
SLF HOS DET					12 M10 60MM MORTARS 8 M29 81MM MORTARS 8 M40 106 MM RR 6 M30 107 MM MORTARS 6 M101A1 105 MM HOW 5 M48 90MM TANKS	AT OKINAWA				
BLT 1/9 (LTCOL D. J. MC ADAMS) 1ST BN, 9TH MARINES MORT BTRY, 2/12 BTRY "D" (REIN), 2/12 PLAT, CO "B", 1ST AMTRACBN PLAT, CO "C", 3D ENGR BN PLAT, CO "C", 3D SP BN PLAT, CO "A", 3D MT BN PLAT, CO "C", 3D RECON BN PLAT, CO "C", 3D TK BN CLEAR PLT, CO "B", 3D MED BN SQD, MP CO, 3D MARDIV DET, HQ BN DET, COMM PLT HQ CO, 9TH MAR DET, 3D DENTAL CO LSU DET BMU NRG	54	1596	6	76				SHIPPING		
HMM-16A (LTCOL R. D. FOWNER)	41	177	1	2					SUPPLIES CLASS I 30 DAYS CLASS II 30 DAYS CLASS III 30 DAYS CLASS IV 30 DAYS CLASS V 30 DAYS	
TOTALS	95	1773	7	78			AIRCRAFT 19 /CH-46A's			

UNCLASSIFIED

Unclassified

**SUMMARY OF MARINE CORPS
AMPHIBIOUS OPERATIONS IN SOUTH VIETNAM**

13 FEBRUARY 1970

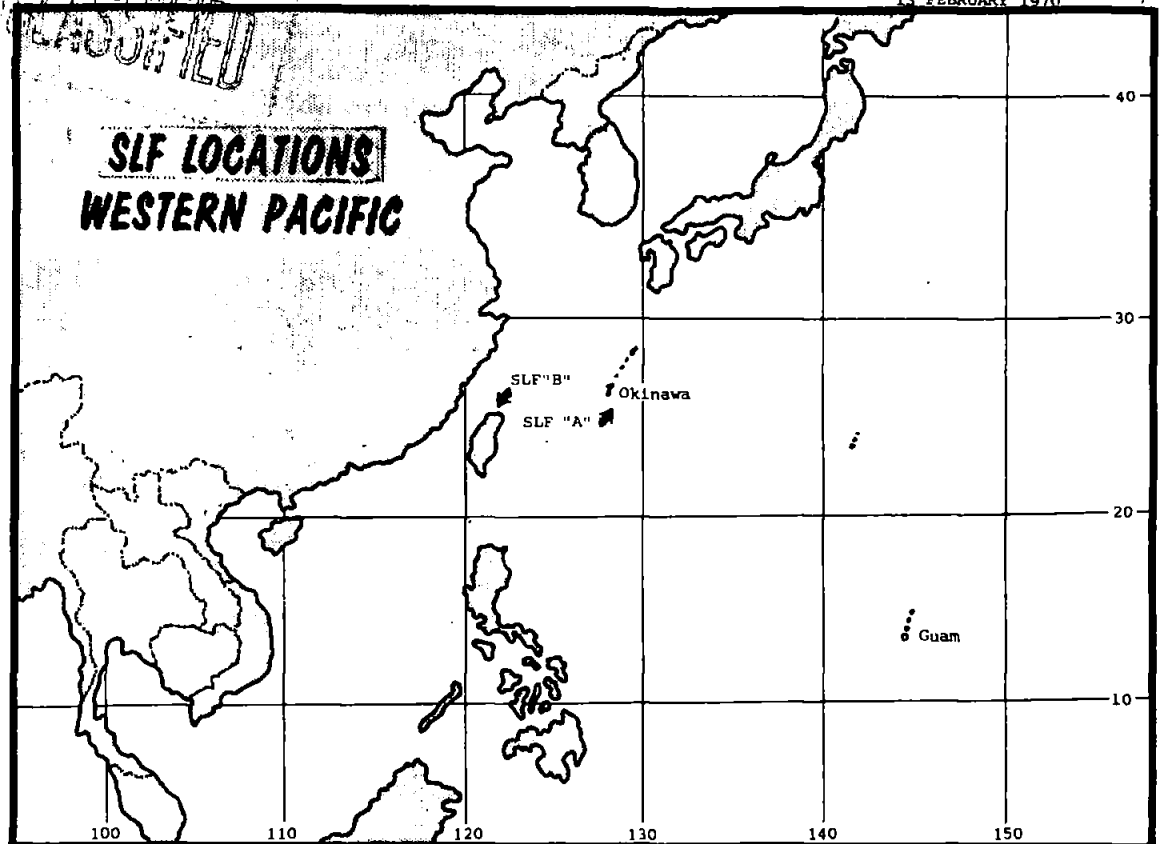

TOTAL AMPHIBIOUS OPERATIONS 71 (INCLUDING SLF OPERATIONS AS INDICATED ON THIS AND SUBSEQUENT PAGES)

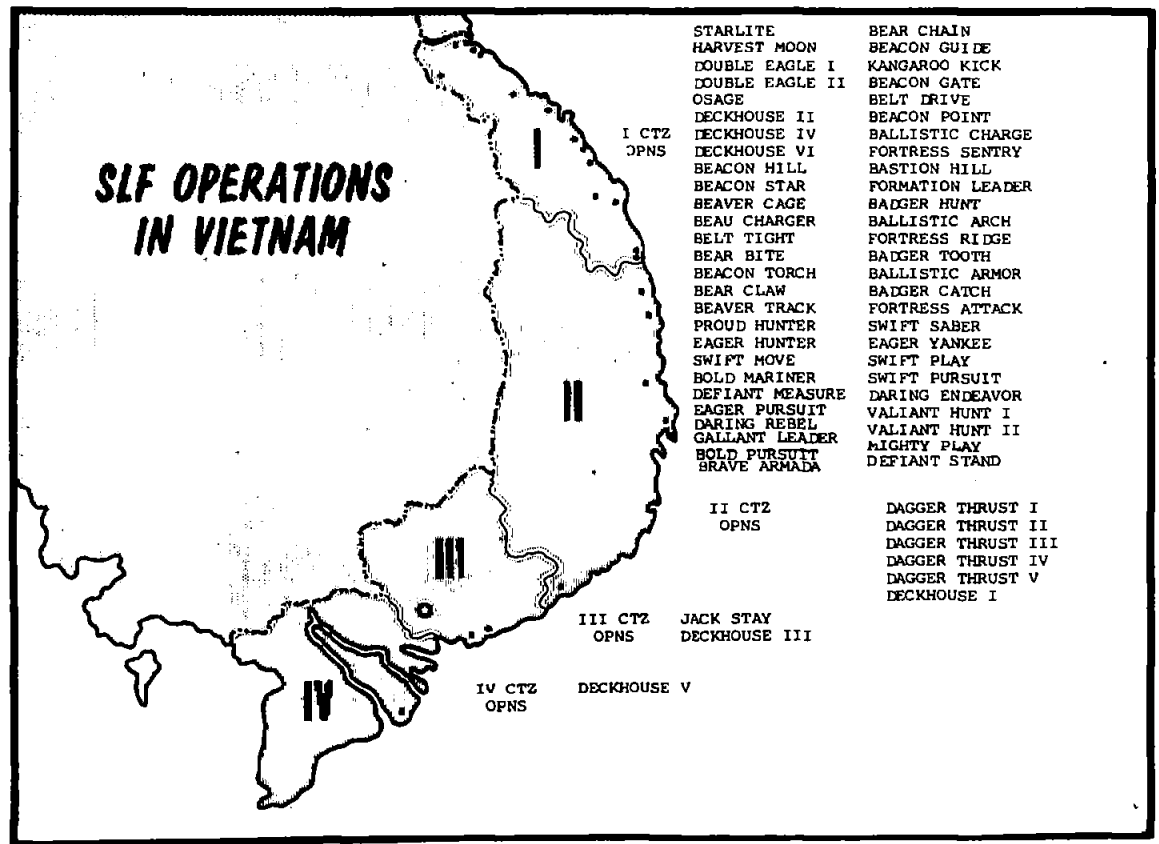

SUMMARY OF SLF OPERATIONS ON FOLLOWING PAGE

UNCLASSIFIED
Unclassified

~~UNCLASSIFIED~~
~~CONFIDENTIAL~~

MARINE CORPS COMMAND CENTER

MILITARY FORCES IN RVN *

13 FEBRUARY 1970

RVN ARMED FORCES (RVNAF)

ARMY (ARVN)	416,278
NAVY (VNN)	30,143
AIR FORCE (VNAF)	36,469
MARINE CORPS (VNMC)	11,528
REGIONAL FORCES (RF)	260,455
POPULAR FORCES (PF)	214,383
TOTAL RVNAF	969,256

UNITED STATES FORCES

ARMY	332,158
NAVY	29,526
AIR FORCE	57,087
MARINE CORPS	52,661
COAST GUARD	375
TOTAL U.S.	471,817

FREE WORLD MILITARY ASSISTANCE FORCES (FWMAF)

REPUBLIC OF KOREA	48,893
AUSTRALIA	7,692
PHILIPPINES	142
THAILAND	11,566
NEW ZEALAND	556
REPUBLIC OF CHINA	28
SPAIN	10
TOTAL FWMAF	68,887

TOTAL FORCES IN RVN 1,509,950

SOURCE: RVNAF MACV MONTHLY GVEN FORCES STRENGTH DATA REPORT.

ALL OTHER, MACV WEEKLY STRENGTH REPORT AS OF 2400, 5FEB70. USMC STRENGTH: MACV WK STRENGTH REPORT AND AS ADJUSTED BY MACV RPT OF ARR/DEP AS OF 2400, 11FEB70.

~~UNCLASSIFIED~~
Unclassified

~~CONFIDENTIAL~~

MARINE CORPS COMMAND CENTER

SELECTED PERSONNEL AND AIRCRAFT DATA

UNCLASSIFIED

PERSONNEL

14 FEBRUARY 1970

	STRENGTH	PERCENT USMC	PERCENT FMF	PERCENT FMFPAC
USMC TOTAL	300,982 *	100.00		
FLEET MARINE FORCES	153,729	51.08	100.00	
FMF ATLANTIC	45,696 \$	15.18	29.73	
FMF PACIFIC	107,599 #	35.90	70.27	
VIETNAM	52,511 †	17.60	34.46	49.04

SOURCE: * MONTHLY USMC PERSONNEL ALLOCATION REPORT OF 30NOV69.
 \$ MCCC UNIT REPORT OF 4FEB70.
 # MCCC UNIT REPORT OF 21JAN70.
 † MACV WEEKLY STRENGTH REPORT AS OF 2400, 5FEB70. AS ADJUSTED BY THE MACV DAILY RPT OF ARR/DEP AS OF 2400, 12FEB70.

AIRCRAFT

5 FEBRUARY 1970

	FIXW	HELO	TOTAL	PERCENT USMC	PERCENT FMF	PERCENT FMFPAC
USMC TOTALS	1013	569	1582	100.00		
FLEET MARINE FORCES	763	543	1306	82.55	100.00	
FMF ATLANTIC	303	156	459	29.01	35.15	
FMF PACIFIC	460	387	847	53.54	64.85	
VIETNAM	156	178	334	21.11	25.57	39.43

SOURCE: MARINE CORPS COMMAND CENTER UNIT REPORT OF 31DEC69.

UNCLASSIFIED

Unclassified

~~CONFIDENTIAL~~

UNCLASSIFIED

MARINE CORPS COMMAND CENTER

FLEET MARINE FORCE DEPLOYMENTS

14 FEBRUARY 1970

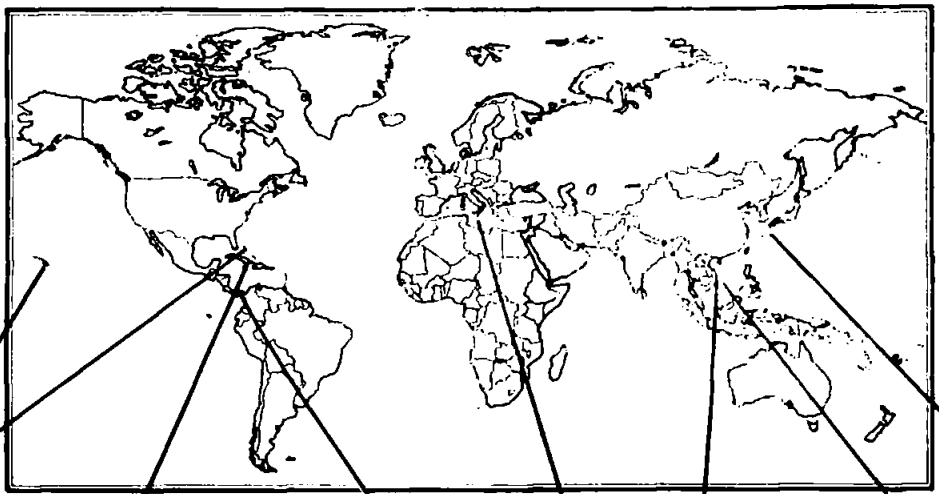

1ST MAR BRIG
HAWAII

DET HJBN 10TH MAR
DET 1/10
DET 2/10
DET 3/10
DET 4/10
DET 2D FAG
DET 1, HMM 264
ENR VIEQUES FOR FIREX

GTMO AUGMENT
2D BN, 8TH MAR
BTRY B/1/10
PLT 2D TK BN
PLT 2D ANGLICO
DET FSR

LANFORCARIB 1-70
BLT 3/2 & HMM-261
AT CRISTOBAL

LANFOR6THFLT 3-69
AT NAVPLION
GREECE

III MAF
RVN

SLF, 7TH FLEET
SLF BRAVO
AT TAIWAN

SLF ALFA
AT OKINAWA

I MEF
OKINAWA
& JAPAN

DET 12TH MAR "D" CO,
3D RECON BN AT FUJI
FOR TRNG.

DISTRIBUTION OF MAJOR FMF UNITS

	INF BNS	VMFA	VMA	VMA(AW)	VMCI	VMN	HMH	HMI	VMO	VMCR
WESTPAC	18	5	2	3	1	6	2	2	2	1
RVN	(12)	(3)	(2)	(2)	(1)	(4)	(1)	(2)	(1)	
OKINAWA/JAPAN	(4)	(2)		(1)			(1)		(1)	(1)
ASSIGNED TO SLF's	(2)					(2)				
MIDPAC	1	2								
HAWAII AFLOAT	(1)	(2)								
EASTPAC	2	* 3	2		1	2	2	1		1
WEST COAST AFLOAT	(2)	(3)	(2)		(1)	(2)	(2)	(1)		(1)
ATLANTIC	8	5	2	3	1	4	2		1	1
EAST COAST CARIBBEAN	(6)	(5)	(2)	(3)	(1)	(3)	(2)		(1)	(1)
	(2)					(1)				
EUROPE	1									
MEDITERRANEAN	(1)									
GRAND TOTAL	30	15	6	6	3	12	6	3	3	3

* CARE

UNCLASSIFIED

Unclassified

~~CONFIDENTIAL~~

MARINE CORPS COMMAND CENTER

UNCLASSIFIED

DISTRIBUTION OF PERSONNEL*

FLEET MARINE FORCE, PACIFIC

14 FEBRUARY 1970

UNIT	NOTE	ASSIGNED STRENGTH		STR RPT DATE	DANANG		CHU LAI		PHU BAI		No I CTZ		OKINAWA		JAPAN		HAWAII		EASTPAC		OTHER		
		USMC	USN		USMC	USN	USMC	USN	USMC	USN	USMC	USN	USMC	USN	USMC	USN	USMC	USN	USMC	USN	USMC	USN	USMC
HEADQUARTERS																							
HQ, FMF, PAC																							
H&S BN, FMF, PAC																							
CAMP S. D. BUTLER																							
CASUAL																							
HOSPITALIZED																							
HQ, V MEB																							
1ST CIVAFFGRP																							
H&S CO, 5TH MEB																							
HQ, FORTRPS, FMF PAC																							
HQCO, FORTRPS																							
HQ, 1ST MAR BRIG																							
HQCO, 1ST MAR BRIG																							
I MEF																							
HQ 3RD MARDIV																							
HQBN 3RD MARDIV																							
HQ III MAF																							
H&S CO III MAF																							
1ST CAG																							
2D CAG																							
3D CAG																							
4TH CAG																							
HQ 1ST MARDIV																							
HQBN 1ST MARDIV																							
INFANTRY																							
1ST MARINES																							
HQ CO																							
1ST BATTALION																							
2D BATTALION																							
3D BATTALION																							
3D MARINES																							
HQ CO																							
1ST BATTALION																							
2D BATTALION																							
3D BATTALION																							
4TH MARINES																							
HQ CO																							
1ST BATTALION																							
2D BATTALION																							
3D BATTALION																							
5TH MARINES																							
HQ CO																							
1ST BATTALION																							
2D BATTALION																							
3D BATTALION																							
7TH MARINES																							
HQ CO																							
1ST BATTALION																							
2D BATTALION																							
3D BATTALION																							
9TH MARINES																							
HQ CO																							
1ST BATTALION																							
2D BATTALION																							
3D BATTALION																							
26TH MARINES																							
HQ CO																							
1ST BATTALION																							
2D BATTALION																							
3D BATTALION																							
ARTILLERY																							
11TH MARINES																							
HQ BTRY																							
1ST BATTALION																							
2D BATTALION																							
3D BATTALION																							
4TH BATTALION																							
12TH MARINES																							
HQ BTRY																							
1ST BATTALION																							
2D BATTALION																							
3D BATTALION																							
4TH BATTALION																							

* UNLESS OTHERWISE NOTED, STRENGTHS AND LOCATION ARE THOSE REPORTED BY UNIT PERSONNEL THIS REPORT IS TO BE REFLECT DAY-TO-DAY ADJUSTMENTS BETWEEN REPORTING PERIODS.

**UNLESS OTHERWISE NOTED STRENGTH REPORT DATE IS 12FEB70.

Unclassified

~~CONFIDENTIAL~~

UNCLASSIFIED

UNCLASSIFIED

DISTRIBUTION OF PERSONNEL

FLEET MARINE FORCE, PACIFIC

14 FEBRUARY 1970

UNIT	NOTE	ASSIGNED STRENGTH		STRENGTH RPT DATE	DANANG		CHU LAI		PHU BAI		No 1 CTZ		OKINAWA		JAPAN		HAWAII		EASTPAC		OTHER	
		USMC	USN		USMC	USN	USMC	USN	USMC	USN	USMC	USN	USMC	USN	USMC	USN	USMC	USN	USMC	USN	USMC	USN
1ST BRIG																						
MAG-24																						
H&MS-24		455																455				
MARS-24		349	27															349	27			
MACS-2		200																200				
MATCU-70		40																40				
VMFA-212		278																278				
VMFA-235		266																266				
3D MAW																						
MWHG-3																						
H&HS-3		671	99																	671	99	
MWFS-3		174																		174		
MWCS-3		265																		265		
MCCRTG-10																						
H&NS-10		279	2																		279	2
VMAT-102		208																			208	
VMT-103		190																			190	
MHTG-30																						
H&MS-30		358	1																		358	1
HMNT-301		164	1																		164	1
HMNT-302		191	1																		191	1
MAG-33																						
H&MS-33		926	1																		926	1
MARS-33		533	3																		533	3
MATCU-65		61																			61	
VMCJ-3		371	1																		371	1
VMA-223	7	166	1																		166	1
VMA-214		218																			218	
VMFA-531		380	1																		380	1
VMFA-542		269	1																		269	1
VMFA-323 (CADRE)		12																			12	
VMFAT-101		511																			511	
MWSSG-37																						
H&MS-37		663	3																		663	3
WERS-37		308	1																		308	1
VMGR-352		371	1																		371	1
MAG-38																						
H&MS-38		312	2																		312	2
MACS-1																						
MACS-1		301																			301	
MACS-3																						
MACS-3		269	4																		269	4
MACS-7																						
MACS-7		284	1																		284	1
1ST LAAM BN																						
1ST LAAM BN		144																			144	
2ND LAAM BN																						
2ND LAAM BN		764	18																		764	18
MAG-56																						
H&MS-56		483																			483	
MARS-56		467	2																		467	2
MATCU-74		81																			81	
HMM-163		255	1																		255	1
HMM-267		383	5																		383	5
HMM-265		215	1																		215	1
HMH-363		274																			274	
MATCU-75		48																			48	
HMH-361	7	185	1																		185	1
USMC		30,998			8,068	3,155	0	0	2,434	3,752	1,649	11,754	186									
USN		458			135	66	0	0	48	27	27	152	3									
AVIATION TOTAL		31,456			8,203	3,221	0	0	2,482	3,779	1,676	11,906	189									

RECAPITULATION OF FMFPAC PERSONNEL DISTRIBUTION

		ASSIGNED STRENGTH	DANANG	CHU LAI	PHU BAI	No 1 CTZ	OKINAWA	JAPAN	HAWAII	EASTPAC	OTHER
GROUND TOTAL	USMC	76,601	38,481	1,569	685	789	16,523	0	3,553	13,145	1,856
	USN	3,431	1,824	21	7	13	899	0	109	514	54
AVIATION TOTAL	USMC	30,998	8,068	3,155	0	0	2,434	3,752	1,649	11,754	186
	USN	458	135	66	0	0	48	27	27	152	3
GRAND TOTAL	USMC	107,599	46,549	4,724	685	789	18,957	3,752	5,202	24,899	2,042
	USN	3,889	1,959	87	7	13	937	27	136	666	57

- NOTES:**
- FIGURES IN "OTHER" ASSIGNED TO SLF'S.
 - FIGURES IN "OTHER" ASSIGNED TO VARIOUS LOCATIONS IN RVN.
 - PERSONNEL IN "OTHER" ARE ASSIGNED TO IT, IIT, SSC, CIT, RED EYE AND NUCLEAR ORINANCE PLATOONS.
 - STRENGTH INCLUDED IN 1ST AND 3D TANK BATTALIONS.
 - THE 559 PERSONNEL LISTED IN "OTHER" ARE HOSPITALIZED AT LOCATIONS OTHER THAN OKINAWA, BUT ARE CARRIED ON THE ROLLS OF CASUAL COMPANY, MCB, CAMP BUTLER.
 - AT SUBIC
 - ENROUTE EASTPAC.
 - PERSONNEL ARE NON-FMP CARRIED FOR OSD PROGRAM STRENGTH TOTALS ONLY.
 - UNLESS OTHERWISE NOTED, STRENGTHS AND LOCATION ARE THOSE REPORTED BY UNIT PERSONNEL STRENGTH REPORTS.
 - REFLECT DAY-TO-DAY ADJUSTMENTS BETWEEN PERIODS.
 - UNLESS OTHERWISE NOTED STRENGTH REPORT DATE IS 12FEB70.

Unclassified

UNCLASSIFIED

MARINE CORPS COMMAND CENTER

SELECTED UNIT COMMANDERS AND STAFF OFFICERS

14 FEBRUARY 1970

UNCLASSIFIED

HEADQUARTERS III MARINE AMPHIBIOUS FORCE

COMMANDING GENERAL	LTGEN H. NICKERSON, JR.
DEPUTY COMMANDER	MGEN G. S. BOWMAN, JR.
CHIEF OF STAFF	BGEN L. J. DULACKI
DEPUTY CHIEF OF STAFF	COL S. A. FRESSIN
ACOS, G-1	COL R. L. PARNELL, JR.
ACOS, G-2	COL E. W. DZIALO
ACOS, G-3	BGEN T. H. MILLER, JR.
ACOS, G-4	COL W. F. SIMLIK
ACOS, G-5	COL C. J. PEABODY
ACOS, G-6	LTCOL R. S. BARRY
ACOS, COMPT	LTCOL J. M. VOSMIK
DEP C/S SPECIAL PROJECTS	COL A. T. WOOD

CG XXIV CTZ	LTGEN M. ZAIS USA
DEP C/S XXIV CTZ	COL M. M. COOK USMC

ACOS, CAP	COL T. E. RETZGER
COMMANDING OFFICER, 1ST CAG	LTCOL D. F. SEILER
COMMANDING OFFICER, 2ND CAG	LTCOL D. R. CHRISTENSEN
COMMANDING OFFICER, 3RD CAG	LTCOL C. M. DANIELS
COMMANDING OFFICER, 4TH CAG	LTCOL J. J. KEENAN
1ST RADIO BATTALION	LTCOL D. M. HOPKINS

1ST MARINE DIVISION

COMMANDING GENERAL	MGEN E. B. WHEELER
ADC	BGEN W. F. DOEHLER
ADC	BGEN C. S. ROBERTSON
CHIEF OF STAFF	COL C. E. WALKER
ACOS, G-1	COL R. E. HARDE
ACOS, G-2	COL F. A. WILCOX
ACOS, G-3	COL F. H. WALDROP
ACOS, G-4	COL N. A. CANZONA
ACOS, G-5	COL L. S. HULLIER
ACOS, COMPT	LTCOL N. M. LASLAVIC, JR.
CEO	COL C. G. DAHL

1ST MARINES

COMMANDING OFFICER	COL F. A. WILCOX
1ST BATTALION	LTCOL G. S. DELGUZE
2ND BATTALION	LTCOL W. V. H. WHITE
3RD BATTALION	LTCOL F. M. BOYD

5TH MARINES

COMMANDING OFFICER	COL R. F. ESTEY
1ST BATTALION	LTCOL J. K. GRIFFIS, JR.
2ND BATTALION	LTCOL F. LEDER
3RD BATTALION	LTCOL J. S. GESTSON

7TH MARINES

COMMANDING OFFICER	COL G. S. CODISPOTI
1ST MARINES	LTCOL C. G. COOPER
2ND MARINES	LTCOL A. E. FOLSOM
3RD MARINES	LTCOL R. G. KUMMEROW

26TH MARINES

COMMANDING OFFICER	COL J. E. HARRELL
1ST BATTALION	LTCOL J. C. GOODIN
2ND BATTALION	LTCOL P. L. HUMPHREY
3RD BATTALION	LTCOL J. J. UNTERKOPFLER

11TH MARINES

COMMANDING OFFICER	COL D. D. EZELL
1ST BATTALION	LTCOL J. D. SHOUP
2ND BATTALION	LTCOL V. WEAVER
3RD BATTALION	LTCOL K. N. MUELLER
4TH BATTALION	LTCOL J. F. BURKE, JR.

1ST BN, 13TH MAR	LTCOL D. H. STRAIN
------------------	--------------------

HQS BATTALION	COL W. C. PATTON
---------------	------------------

1ST ENGR BATTALION	LTCOL N. F. GLOWICKI
1ST RECON BATTALION	LTCOL W. C. DRUMWRIGHT
1ST MT BATTALION	LTCOL M. S. SHIMANOFF
1ST SP BATTALION	LTCOL R. F. ARMSTRONG
1ST MED BATTALION	CAPT(MC) J. W. LEA
1ST TK BATTALION	MAJOR J. I. LOUDER
3RD AMTRAC BATTALION	LTCOL D. G. MEHARGUE
7TH ENGR BATTALION	LTCOL W. G. BATES
9TH ENGR BATTALION	LTCOL E. K. MAXWELL
11TH MT BATTALION	LTCOL W. R. KEPHART

FORCE LOGISTICS COMMAND

COMMANDING GENERAL	BGEN M. J. PADALINO
CHIEF OF STAFF	COL J. L. TOBIN
ACOS, G-1	LTCOL J. E. REDELFS
ACOS, G-2	LTCOL R. L. SOLZE
ACOS, G-3	LTCOL W. W. STORM, III
ACOS, G-4	LTCOL M. H. IVINS
ACOS, G-5	MAJOR R. E. JOHNSON
ACOS, COMPT	LTCOL F. R. WARREN
CEO	MAJOR R. D. HAGAN

1ST FORCE SERVICE REGT

HQS BATTALION	LTCOL L. R. WEBB
SUPPLY BATTALION	COL R. W. CALVERT
MAINT BATTALION	LTCOL E. C. MORRIS

FLSG-B/1ST SERV BN

5TH COMM BATTALION (REIN)	COL D. E. MORIN
7TH MT BATTALION	LTCOL D. E. SHATZER
1ST MP BATTALION	LTCOL R. L. PRATHER
3RD MP BATTALION	LTCOL S. D. THOMAS, III
	LTCOL C. FIMIAN

UNCLASSIFIED

SELECTED UNIT COMMANDERS AND STAFF OFFICERS

UNCLASSIFIED

14 FEBRUARY 1970

1ST MARINE AIRCRAFT WING		3D MARINE AIRCRAFT WING	
COMMANDING GENERAL AWC	MGEN W. G. THRASH	COMMANDING GENERAL AWC	MGEN R. G. OWENS, JR.
CHIEF OF STAFF	BGEN R. H. SPANJER	BGEN J. A. FEELEY, JR.	
ACOS, G-1	COL R. W. TELLER	COL H. N. MEHAFFEY	
ACOS, G-2	COL G. S. STEWART	LTCOL L. A. GULLING	
ACOS, G-3	COL J. R. WEAVER	COL R. J. GRAHAM	
ACOS, G-4	COL R. L. LAMAR	COL D. WILKER	
ACOS, COMPT	COL W. C. MCGRAW		
CEO	COL E. J. ARTNAK		
	LTCOL T. KALUS		
<u>MWHG-1</u>		<u>MWHG-3</u>	
COMMANDING OFFICER	COL L. J. STIEN	COMMANDING OFFICER	COL G. L. LILLICH
H&MS-1	MAJ W. S. HUMBERT	H&MS-3	LTCOL J. B. LAVELLE
MWFS-1	LTCOL N. F. SCHNIPPEL, JR.	MWFS-3	MAJOR J. S. LOOP
MWCS-1	MAJOR A. B. RAY	MWCS-3	MAJOR D. B. NEWTON
<u>MWSG-17</u>		<u>MHTG-30</u>	
COMMANDING OFFICER	COL H. L. JENSEN	COMMANDING OFFICER	COL A. F. GAROTTO
H&MS-17	LTCOL D. SERRIN	H&MS-30	LTCOL R. W. CREIGHTON
WERS-17	MAJOR W. F. FARLEY	HMHT-301	LTCOL L. W. JARMAN
		HMMT-302	LTCOL K. D. VANEK
<u>MACG-18</u>		<u>MAG-33</u>	
COMMANDING OFFICER	COL S. G. DUNWIDDIE, JR.	COMMANDING OFFICER	COL F. N. PIPPIN
H&MS-18	LTCOL H. E. HOPPEYER, JR.	H&MS-33	LTCOL R. H. HUTCHINSON
MACS-4	LTCOL R. W. MOLYNEUX, JR.	MABS-33	MAJOR J. E. KEHRLE
		VNCJ-3	LTCOL R. E. PERCIVAL
MASS-3	LTCOL J. H. DUBOTS	VMA-214	LTCOL W. R. SMITH
		VMFA-323 (CAIRE)	MAJ K. A. ZIMMERMAN II
		VMFAT-101	LTCOL R. W. KRON
		VMFA-531	LTCOL J. L. THATCHER
		VMFA-542	LTCOL K. A. SMITH
		VMA-223	LTCOL J. W. IAZZO
<u>MAG-11</u>		<u>MWSC-37</u>	
COMMANDING OFFICER	COL N. E. HEFFERNAN	COMMANDING OFFICER	COL F. E. WILSON
H&MS-11	LTCOL R. F. HEBERT	H&MS-37	LTCOL D. L. RICE
MABS-11	LTCOL P. A. MANNING	WERS-37	LTCOL R. W. DUPHINEY
VNCJ-1	LTCOL B. W. FARLEY	VHGR-352	LTCOL H. D. STOTT
VMA(AW)-225	LTCOL J. J. METZKO		
VMA(AW)-242	LTCOL S. P. LEWIS		
VMO-2	LTCOL J. M. MORIARITY		
<u>MAG-12</u>		<u>MAG-38</u>	
COMMANDING OFFICER	COL J. R. WEAVER	COMMANDING OFFICER	LTCOL T. I. GUNNING
H&MS-12	LTCOL J. J. WENT	H&MS-38	MAJOR F. L. HARDING
MABS-12	LTCOL G. J. ERTLMEIR	SU#1, H&MS-38	MAJOR D. V. STOWELL
VMA-311	MAJOR A. R. HICKLE	MACS-1	MAJ C. F. KELLENBARGER
VMA-211	LTCOL L. GASPERINE, JR.	MACS-3	LTCOL T. M. KAUFFMAN
VMA-223	LTCOL J. W. IAZZO	MACS-7	LTCOL D. E. ROBERTS
		1STLAAM BN	MAJOR E. L. HOUSE, JR.
		2NDLAAM BN	MAJOR H. J. BALDWIN, JR.
<u>MAG-13</u>		<u>MAG-56</u>	
COMMANDING OFFICER	LTCOL T. E. MURPHREE	COMMANDING OFFICER	COL M. D. PORTER
H&MS-13	MAJOR F. J. HORAK, JR.	H&MS-56	LTCOL G. H. BUCKNER II
MABS-13	MAJOR R. D. REVIE	MABS-56	LTCOL F. L. YOHE
VMFA-115	LTCOL D. P. BOWEN	HMH-363	LTCOL R. P. BRAY
VMFA-314	LTCOL T. J. KELLY	HML-267	LTCOL J. M. BLANC
VMFA-122	LTCOL R. E. HOWARD, JR.	HMH-361	MAJ R. A. GOVANI
		HMM-163	LTCOL F. A. MATHENS
		HMM-265	LTCOL R. G. COUNTRY
<u>MAG-16</u>		<u>MCCRTG-10</u>	
COMMANDING OFFICER	COL J. P. BRUCE	COMMANDING OFFICER	COL G. FINK
H&MS-16	MAJOR M. T. HORNSBY	H&MS-10	MAJ I. L. DRIEFER
MABS-16	LTCOL P. C. SCAGLIONE	VMAT-102	LTCOL B. A. SCHAPPER
		VMT-103	LTCOL M. T. GARRISON
HMH-463	LTCOL C. A. BLOCK		
HML-167	LTCOL J. E. WEBER		
HMM-364	LTCOL C. R. DUNBAUGH		
HMM-263	LTCOL W. R. LEDBETTER		
HMM-161	MAJOR B. H. MANN		
HMM-262	LTCOL R. A. BANCROFT		
HML-367	LTCOL W. G. CRETNEY		

UNCLASSIFIED

MARINE CORPS COMMAND CENTER

5TH MARINE EXPEDITIONARY BRIGADE

READINESS SUMMARY

14 FEBRUARY 1970

UNIT	*REPORT DATE	STRENGTH		COMBAT READINESS								
				USMC	USN	RATING	CURRENT				EXPECTED	
							REASON	P	S	E	T	RATING
5TH MEB						T	1	1	1	2	C1	30APR70
H&SCO (-) (REIN)		1393	27				1	1	1	1		
3D MARINES (-)						P	2	1	1	2	C1	1FEB70
HQS CO (-)		289	9				1	1	1	1		
2nd BN		1081	56			T	1	1	1	2	C1	1FEB70
3rd BN		1086	55			P	2	1	1	2	C1	1FEB70
1ST BN, 12TH MARINES (-)		1095	21			X	1	1	1	1		
"A" CO, 3D AT BN (-)		94	7			T	1	1	1	2	C1	1MAR70
"A" CO, 3D RECON BN (-)		92	5			T	1	1	1	2	C1	1FEB70
"C" CO, 3D MED BN (-)		78	53			P	2	1	1	2	C1	28FEB70
"B" CO, 3D ENGR BN (-)		155	1				1	1	1	1		
"B" CO, 3D MT BN (-)		76	1			T	1	1	1	2	C1	31JAN70
"B" CO, 3D SP BN (-)		133	16				1	1	1	1		
"D" CO, 3D TANK BN (REIN)		197	7			T	1	1	1	2	C1	1MAR70
DET, 3D SERVICE BN		911	18				1	1	1	1		
REINFORCING UNITS												
COMM SPT CO, 9TH COMM BN		268				T	1	1	1	2	C1	1FEB70
"B" CO, 11TH ENGR (REIN)		252	2				1	1	1	1		
"B" CO, 9TH MT BN (REIN)		159	1				1	1	1	1		
"A" CO, 1ST AMTRAC BN (-)		218	4				1	1	1	1		
13TH ITT		15				P	1	1	1	1	C2	31JULY70
9TH SSCT		6					1	1	1	1		
13TH CIT		29					1	1	1	1		
1ST SEARCHLIGHT BTRY						C4	N	4	4	4	C4	1FEB70
9TH SEP BULK FUEL CO		356				C3	T	1	1	1	C2	15JAN70
DET, 5TH DENTAL CO		16					1	1	1	1		
3D BRIDGE CO (-)		141	1			C2	T	1	1	1	C1	28FEB70
3D HOSPITAL CO		36	63			C2	P	2	1	1	C1	30JUN70
1ST AMRD AMPHIB CO (-)		88				C4	S	1	4	4	C3	1JUN70
1ST CIVIL AFFAIRS GROUP		74	4			C4	T	3	1	1	C3	1FEB70
21ST ITT		8				C4	P	4	1	1	C3	31JAN70

READINESS CATEGORIES

- C-1 Fully Combat Ready
- C-2 Substantially Combat Ready
- C-3 Marginally Combat Ready
- C-4 Not Combat Ready

READINESS ABBREVIATIONS

- P Personnel Readiness
- S Supplies/Equipment on Hand
- E Equipment Readiness
- T Training Readiness
- X Commanders Subjective Judgment-Elaborated by remarks
- N Resource allocation by cognizant service does not permit a higher C-rating

NOTE: Readiness Category Information extracted from SMU REPORT DATES 2FEB70.
Strength Category Information extracted from MCCC Report dated 12FEB70.

Unclassified

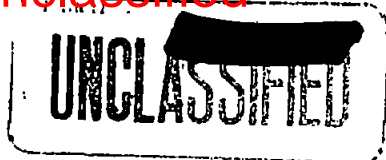

~~SECRET~~

UNCLASSIFIED

MARINE CORPS COMMAND CENTER

MARINE CORPS PERSONNEL IN RVN

14 FEBRUARY 1970

	OFF	ENL	TOTAL
* III MAF.	3,485	48,715	52,200
DANANG	(2,986)	(42,320)	(45,306)
CHU LAI	(391)	(4,824)	(5,215)
PHU BAI	(73)	(868)	(941)
DONG HA	(35)	(703)	(738)
SU #1, 1ST ANGLICO (AT VARIOUS LOCATIONS SVN)	((21))	((191))	((212))
OTHER USMC PERSONNEL	159	152	311
MACV STAFF/MACV FIELD	(136)	(139)	(275)
NAVADVGRU/NAVY UNITS	(23)	(13)	(36)
USMC IN RVN CHARGED AGAINST PROGRAM VIII	3,644	48,867	52,511
U. S. NAVY, III MAF.	256	1,784	2,040

* AS REPORTED BY III MAF DAILY ADMIN SITREP # 42 AS OF 2400, 10FEB70 AND THE MACV WEEKLY STRENGTH REPORT, AS OF 2400, 5FEB70 AS ADJUSTED BY MACV DAILY RPT OF ARR/DEP AS OF 2400, 12FEB70

Unclassified

UNCLASSIFIED

~~SECRET~~

~~SECRET~~

UNCLASSIFIED

MARINE CORPS COMMAND CENTER

WESTPAC UNIT LOCATIONS

14 FEBRUARY 1970

QUANG TRI

(QUANG TRI)

- 1ST BDE, 5TH INF DIV (MECH)
 - 1/77 ARMOR (OPN GREENE RIVER)
 - 1/61 INF (MECH) (OPN GREENE RIVER)
 - 1/11 INF (OPN GREENE RIVER)
 - 3/5 ARMD CAV SQDN (OPN GREENE RIVER)

USMC 738 ●
 USN 37 ●
 USA 5,826 ●

THUA THIEN

HO, XXIV CORPS (PHU BAI)

HO, 101st ABN DIV (AM)

- 1ST BDE, 101ST ABN DIV (AM)
 - 1/327 INF (AM) (OPN RANDOLPH GLEN)
 - 2/327 INF (AM) (OPN RANDOLPH GLEN)
 - 2/502 INF (AM) (OPN RANDOLPH GLEN)

- 2D BDE, 101ST ABN DIV (AM)
 - 1/501 INF (AM) (OPN RANDOLPH GLEN)
 - 2/501 INF (AM) (OPN RANDOLPH GLEN)
 - 1/502 INF (AM) (OPN RANDOLPH GLEN)

- 3D BDE, 101ST ABN DIV (AM)
 - 1/506 INF (AM) (OPN RANDOLPH GLEN)
 - 2/506 INF (AM) (OPN RANDOLPH GLEN)
 - 3/187 INF (AM) (OPN RANDOLPH GLEN)

USMC 941 ●
 USN 46 ●
 USA 16,259 ●

1st MAW
 MAG-16
 HML-367 (UH-1E)

QUANG NAM

HQS, III MAF

- 1ST MARINES
 - 1/1
 - 2/1
 - 3/1

- 5TH MARINES
 - 1/5
 - 2/5
 - 3/5

- 7TH MARINES
 - 1/7
 - 2/7
 - 3/7

- 26TH MARINES
 - 1/26
 - 2/26
 - 3/26

HQS, III MAF USMC 45,306 ●
 USN 1,841 ●
 USA 1,110 ●
 HO 1st MAW ROKMC 7,145
 MAG-11

- VMA(AW)-242 (A-6A)
- VMA(AW)-225 (A-6A)
- VMCJ-1 (RF-4/EA-6/EF-10)
- VMO-2 (AH-1G/OV-10A)

- MAG-16 (-) (UH-1E)
- HML-167 (CH-53A)
- HMH-463 (CH-46D)
- HMM-364 (CH-46D)
- HMM-263 (CH-46D)
- HMM-262 (CH-46D)
- HMM-161 (CH-46D)

- 2d ROKMC BDE
- 1/2 (OPN VICTORY DRAGON XIX)
 - 2/2 (OPN VICTORY DRAGON XIX)
 - 3/2 (OPN VICTORY DRAGON XIX)
 - 5/2 (OPN VICTORY DRAGON XIX)

FLC 1ST FSR/FLSG-B/1ST SERV BN

QUANG TIN/QUANG NGAI

HO 23d INF DIV (AMICAL) (CHU LAI)

- 196TH LT INF BDE
 - 2/1 INF (OPN FREDERICK HILL)
 - 4/31 INF (OPN FREDERICK HILL)
 - 3/21 INF (OPN FREDERICK HILL)
 - 1/46 INF

- 198TH LT INF BDE
 - 1/6 INF (OPN GENEVA PARK)
 - 1/52 INF (OPN GENEVA PARK)
 - 5/46 INF (OPN NANTUCKET BEACH)

- 117TH INF BDE
 - 1/20 INF (OPN IRON MOUNTAIN)
 - 4/21 INF (OPN IRON MOUNTAIN)
 - 3/1 INF (OPN IRON MOUNTAIN)
 - 4/3 INF (OPN IRON MOUNTAIN)
 - 1/1 ARMD CAV SQDN (OPN IRON MOUNTAIN)

- 1st MAW
- MAG-12 (A-4E)
 - VMA-211 (A-4E)
 - VMA-311 (A-4E)

- MAG-13
- VMFA-115 (F-4B)
 - VMFA-314 (F-4B)
 - VMFA-122 (F-4B)

USMC 5,215 ●
 USN 116 ●
 USA 24,391 ●

OKINAWA

HQ, I MEF
 3D MAR DIV (-) (REIN)(TF-79)
 11th MEB (TF-79.1)

- 4TH MARINES
 - 1/4
 - 2/4
 - 3/4
- 9TH MARINES
 - 3/9

OSD PROGRAM VIII CEILING 19,200 934
 ACTUALS CHARGED AGAINST PROGRAM VIII AS OF 5FEB70. 18,580 424
 MAG-36 (14,061 (349)
 VMGR-152 (KC-130F)
 VMO-6 (OV-10A/UH-1E)
 HMH-462 (CH-53A)

3D FSR (3,456) (50)
 MCB CAMP BUTLER/NON FMF (915) (25)
 Non-Deployable Casuals (148)
 SVN-Originated Patients (0)

USMC 19,200
 USN 934

USMC RVN RECAP

	USMC	USN
OSD PROGRAM VIII CEILING	55,510	2,233
ACTUALS CHARGED AGAINST PROGRAM VIII AS OF 12FEB70.	52,511 ●	2,040 ●
III MAF.	52,206 ●	2,040 ●
SU#1 1ST ANGLICO	(212)	(14)
OTHER.	311	
MACV STAFF/MACV FIELD.	(275)	
NAVAIR/GRU/NAVY UNITS	(36)	

I CORPS RECAP

US MARINE CORPS.	(12 BNs)	52,200 ●
US ARMY	(25 BNs)	73,849
US NAVY		16,954 ●
US AIR FORCE		8,194
ROKMC	(4 BNs)	6,148
RVNAF	(36 BNs)	153,895
ARVN/ABN.	(36 BNs)	(74,634)
VNMC		
VNN		(2,100)
VNAF		(3,408)
VNRF		(37,403)
VNPF		(36,350)
I CORPS TOTAL	77 BNs	311,240 ●

SLF 7TH FLEET

	USMC	USN
BRavo: BLT 2/9	1,847	60
HMM-165		
AT TAIWAN		
ALFA: BLT 1/9	1,868	85
HMM-164		
AT OKINAWA		

MOVEMENTS

Det 12th Mar and "D" Co, 3d Recon Bn. At Fuji for training.

JAPAN

	USMC	USN
OSD PROGRAM VIII CEILING	3,600	45
ACTUALS CHARGED AGAINST PROGRAM VIII AS OF 5FEB70.	3,749	34
1ST MAW (REAR)		
MAG-15	(2,553)	(34)
VMFA-232 (F-4J)		
VMFA-334 (F-4J)		
VMA(AW)-533 (A-6A)		

*Does NOT include 243 hospitalized SVN-Originated Patients.

Non FMF (1,196)

Unclassified

* Includes only U. S. Navy Personnel organic to FMF Units.
 # Includes SU#1 and 1st ANGLICO at various locations throughout SVN.
 Latest Change

SECRET UNCLASSIFIED

MARINE CORPS

FEB 16 1970

REFERENCE BRANCH

Unclassified

UNCLASSIFIED

USMC/ENEMY CASUALTIES IN RVN

14 FEBRUARY 1970

USMC BATTLE CASUALTIES

KIA/DOW	WIA(EVAC)	WIA(RTD)	MIA/PW
12,450	48,819	35,794	80/21

USMC CASUALTY FIGURES ARE PROVIDED DAILY BY HOMC CASUALTY SECTION (CODE DNA) AND REFLECT ALL CASUALTIES REPORTED AS OF 12 FEB 70.

USMC NON-BATTLE CASUALTIES

DEAD	INJURED	MISSING
1,505	1,822	12

FIGURES INDICATED AS INJURED ARE ONLY THOSE IN SERIOUS/CRITICAL INJURY OR DISEASE CATEGORY AND DO NOT INCLUDE THOSE OF A MINOR NATURE

USMC INFLECTED ENEMY CASUALTIES

KIA	PW	WPNS
80,499	4,190	20,797

ENEMY CASUALTIES ARE COMPILED DAILY FROM THE III MAF HISSUM AND ARE RECONCILED MONTHLY WITH THE FMPAC SUMMARY OF USMC OPERATIONS IN RVN

TYPICAL DISPOSITION OF 100 USMC WIA *

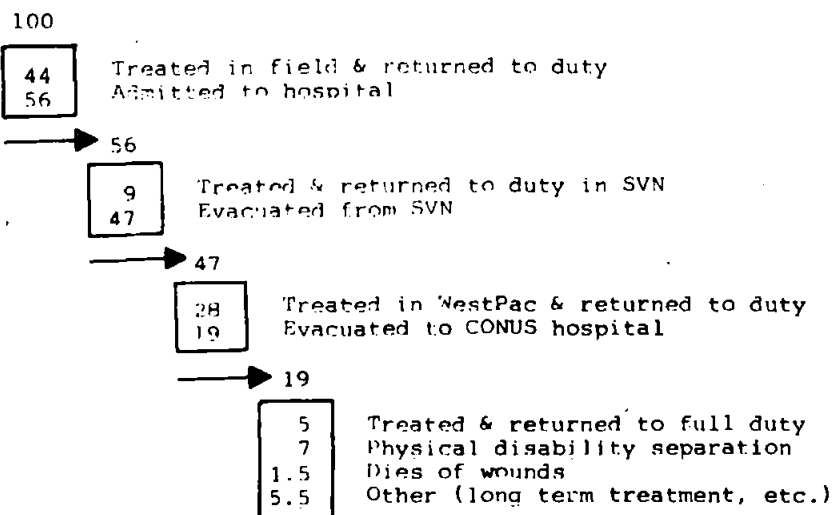

*54,081 CASUALTIES, JAN67-DEC68.

UNCLASSIFIED

Unclassified

~~CONFIDENTIAL~~
UNCLASSIFIED

MILITARY FORCES IN RVN *

14 FEBRUARY 1970

RVN ARMED FORCES (RVNAF)

ARMY (ARVN)	416,279
NAVY (VNN)	30,143
AIR FORCE (VNAF)	36,469
MARINE CORPS (VNMC)	11,528
REGIONAL FORCES (RF)	260,455
POPULAR FORCES (PF)	214,383
TOTAL RVNAF	969,256

UNITED STATES FORCES

ARMY	332,158
NAVY	29,526
AIR FORCE	57,087
MARINE CORPS	52,511
COAST GUARD	375
TOTAL U.S.	471,667

FREE WORLD MILITARY ASSISTANCE FORCES (FWMAF)

REPUBLIC OF KOREA	48,893
AUSTRALIA	7,692
PHILIPPINES	142
THAILAND	11,566
NEW ZEALAND	556
REPUBLIC OF CHINA	28
SPAIN	10
TOTAL FWMAF	68,887

TOTAL FORCES IN RVN 1,509,800

SOURCE: RVNAF MACV MONTHLY GIVEN FORCES STRENGTH DATA REPORT.

ALL OTHER, MACV WEEKLY STRENGTH REPORT AS OF 2400, 5FEB70. USMC STRENGTH: MACV WK STRENGTH REPORT AND AS ADJUSTED BY MACV RPT OF ARR/DEP AS OF 2400 12FEB70.

~~CONFIDENTIAL~~
UNCLASSIFIED
Unclassified

UNCLASSIFIED

**MARINE CORPS COMMAND CENTER
REPUBLIC OF KOREA MARINE CORPS**

14 FEBRUARY 1970

Commandant: Gen CHUNG, Kwang Ho

Strength: 31,300 (Mar69)

Senior Marine Advisor: Col W. E. MC CAIN, USMC

The Headquarters of the Republic of Korea Marine Corps (ROKMC) is located in SEOUL and is supported by a Marine Barracks. Marine Barracks are also located at five major Naval Bases or stations. These are at CHINHAE, MUKHO, PUSAN, INCHEON AND CHEJU-DO. The Marine Corps Schools are located at CHINHAE and include the Recruit and Officer Cadet Schools, NCO School, Drill Instructor School, LVT School, Junior and Senior Amphibious Warfare Schools, Junior and Senior Staff School, Supply School, Officer Training School, Officer Candidate School and Recruit Training. The ROKMC is organized operationally as indicated below:

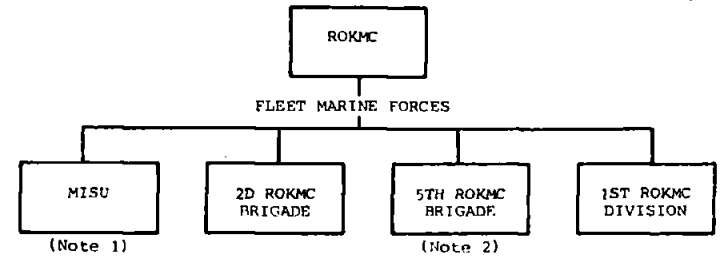

Note 1: Marine Island Security Unit (MISU) is a defense force approximating an infantry battalion in size and weaponry. Located on the offshore islands of the westerly extension of the DMZ, it is administratively controlled by ROKMC and operationally controlled by COMROKFLT.

Note 2: The 5th ROK Marine Brigade, activated on 23 November 1966 as an in-country replacement for the 2d ROK Marine Brigade deployed to Vietnam, is currently employed along the DMZ at KIMPO PENINSULA. Administratively controlled by CG, 1st ROK Marine Division, it is under the operational control of I Corps (GP) EUSA.

The 1st ROK Marine Division (-) is located at Marine Corps Base, POHANG. One infantry regiment and supporting divisional elements are task organized as the 5th ROK Marine Brigade (See Note 2 above). The 1st ROK Marine Division is organized as indicated below. Figures beneath blocks indicate authorized strengths, the divisional totals include those elements assigned to the 5th ROK Marine Brigade.

CG: MGen CHUNG Kwang Ho

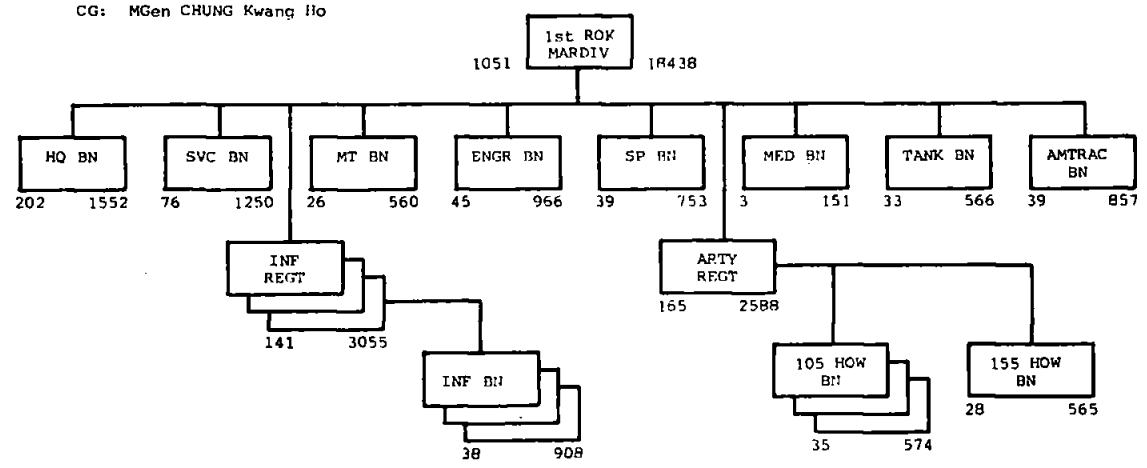

The 2d ROK Marine Brigade is deployed to the republic of Vietnam. The Brigade is assigned to the HOI AN tactical area and is under the "Operational Guidance" of III MAF. The 2d ROK Marine Brigade is organized as indicated below. Figures beneath blocks indicate authorized strengths.

CG: RGEN LEE Dong Yong

Strength: 6,717 (June69)

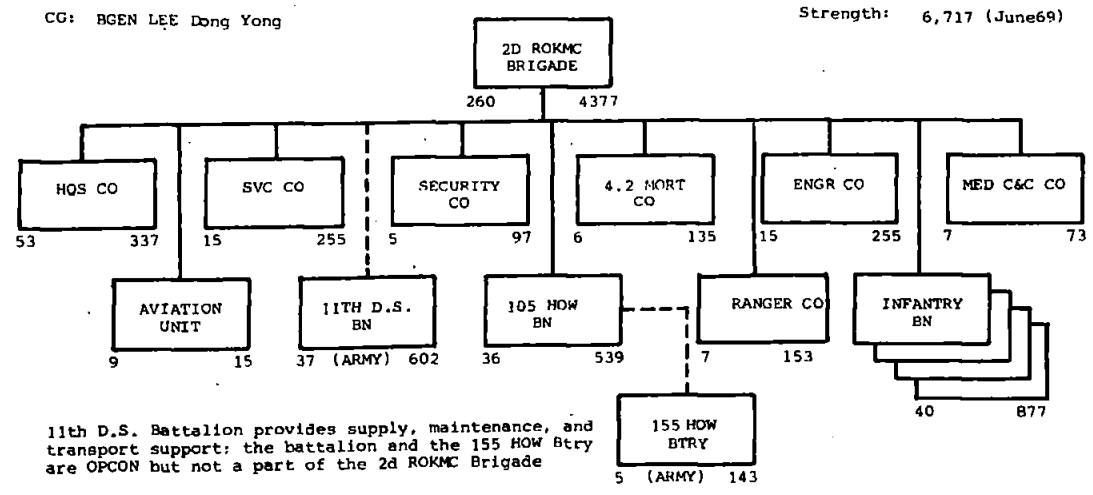

11th D.S. Battalion provides supply, maintenance, and transport support; the battalion and the 155 HOW Btry are OPCON but not a part of the 2d ROKMC Brigade

Note: Senior Officer from the Republic of Korea in SVN
is: LtGen LEE Sae Ho (Commander ROK Forces, Vietnam)

SECRET
UNCLASSIFIED

UNCLASSIFIED
SUMMARY OF MAJOR US AND FWMAF OPERATIONS

OPERATION (DATE COMMENCED)	UNITS INVOLVED	LOCATION	CASUALTIES AS OF: 152400H FEB70		
			FRIENDLY		ENEMY
			KIA	WIA	KIA
GREENE RIVER (19JAN70)	1ST BDE, 5TH INF DIV (MECH): 4 USA BNS	EASTERN QUANG TRI PROVINCE	4	103	57
RANDOLPH GLEN (7DEC69)	101ST ABN DIV (AM): 9 USA BNS	QUANG TRI & THUA THIEN PROVINCES	55	256	410
VICTORY DRAGON XIX (1JAN70)	2D ROKMC BDE: 4 ROKMC BNS	HOI AN AREA	1	12	9
FREDERICK HILL (18MAR69)	196TH INF BDE: 3 USA BNS	QUANG TIN PROVINCE	369	*2,335	*4,488
GENEVA PARK (18JUL69)	198TH INF BDE: 2 USA BNS	QUANG TIN & QUANG NGAI PROVINCES	126	857	1,141
NANTUCKET BEACH (20JUL69)	198TH INF BDE: 1 USA BN	CENTERED 15 KM NE OF QUANG NGAI CITY	24	216	250
IRON MOUNTAIN (18MAR69)	11TH INF BDE: 5 USA BNS	QUANG NGAI PROVINCE	288	*1,671	2,493

* - ADJUSTED
- FINAL CUMULATIVE CASUALTIES

UNCLASSIFIED

Unclassified

UNCLASSIFIED

MARINE CORPS COMMAND CENTER

SELECTED PERSONNEL AND AIRCRAFT DATA

PERSONNEL

16 FEBRUARY 1970

	STRENGTH	PERCENT USMC	PERCENT FMF	PERCENT FMPAC
USMC TOTAL	300,982 *	100.00		
FLEET MARINE FORCES	153,729	51.08	100.00	
FMF ATLANTIC	45,696 \$	15.18	29.73	
FMF PACIFIC	107,599 #	35.90	70.27	
VIETNAM	52,575 †	17.60	34.46	49.04

SOURCE: * MONTHLY USMC PERSONNEL ALLOCATION REPORT OF 30NOV69.
 \$ MCCC UNIT REPORT OF 4FEB70.
 # MCCC UNIT REPORT OF 21JAN70.
 † MACV WEEKLY STRENGTH REPORT AS OF 2400, 12FEB70 AS ADJUSTED BY THE MACV DAILY RPT OF ARR/DEP AS OF 2400, 13FEB70.

AIRCRAFT

5 FEBRUARY 1970

	FIXW	HELO	TOTAL	PERCENT USMC	PERCENT FMF	PERCENT FMPAC
USMC TOTALS	1013	569	1582	100.00		
FLEET MARINE FORCES	763	543	1306	82.55	100.00	
FMF ATLANTIC	303	156	459	29.01	35.15	
FMF PACIFIC	460	387	847	53.54	64.85	
VIETNAM	156	178	334	21.11	25.57	39.43

SOURCE: MARINE CORPS COMMAND CENTER UNIT REPORT OF 31DEC69.

UNCLASSIFIED

Unclassified

~~CONFIDENTIAL~~

UNCLASSIFIED

FLEET MARINE FORCE DEPLOYMENTS

16 FEBRUARY 1970

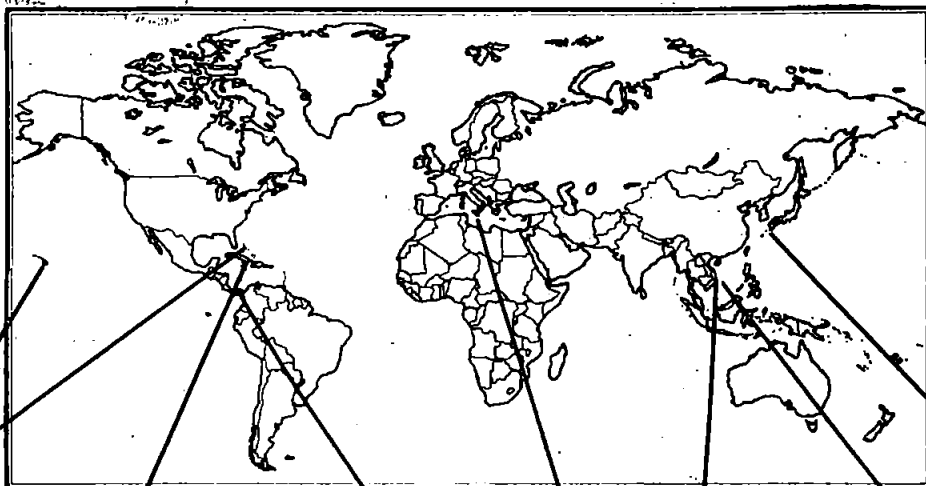

1ST MAR BRIG
HAWAII

I MEF
OKINAWA
& JAPAN

DET HJBN 10TH MAR
DET 1/10
DET 2/10
DET 3/10
DET 4/10
DET 2D FAG
DET 1, HMM 264
ENR VIEQUES FOR FIREX

GIMO AUGMENT

2D BN, 8TH MAR
BTAY E/1/10
PLT 2D TK BN
PLT 2D ANGLICO
DET FSR

LANFORCARIB 1-70

BLT 3/2 & HMM-261
ENR LIBERTY PORTS
ETA 20FEB70

LANFOR6THFLT 3-69

AT NAVPLION
GREECE

III MAF

RVN

SLF, 7TH FLEET

SLF BRAVO
AT TAIWAN

DET 12TH MAR "D" CO,
3D RECON BN AT FUJI
FOR TRNG.

SLF ALFA
AT OKINAWA

DISTRIBUTION OF MAJOR FMF UNITS

	INF BNS	VMFA	VMA	VMA(AW)	VMCJ	BMM	BMR	BML	VMO	VMGR
WESTPAC	18	5	2	3	1	6	2	2	2	1
RVN	(12)	(3)	(2)	(2)	(1)	(4)	(1)	(2)	(1)	
OKINAWA/JAPAN	(4)	(2)		(1)			(1)		(1)	(1)
ASSIGNED TO SLF's	(2)					(2)				
MIDPAC	1	2								
HAWAII	(1)	(2)								
AFLOAT										
EASTPAC	2	* 3	2		1	2	2	1		1
WEST COAST	(2)	(3)	(2)		(1)	(2)	(2)	(1)		(1)
AFLOAT										
ATLANTIC	8	5	2	3	1	4	2		1	1
EAST COAST	(6)	(5)	(2)	(3)	(1)	(3)	(2)		(1)	(1)
CARIBBEAN	(2)					(1)				
EUROPE	1									
MEDITERRANEAN	(1)									
GRAND TOTAL	30	15	6	6	3	12	6	3	3	3

* CAFRE

UNCLASSIFIED

~~SECRET~~
UNCLASSIFIED

MARINE CORPS COMMAND CENTER

MARINE CORPS PERSONNEL IN RVN

16 FEBRUARY 1970

	OFF	ENL	TOTAL
* III MAF.	3,485	48,782	52,267
DANANG	(2,986)	(42,387)	(45,373)
CHU LAI	(391)	(4,824)	(5,215)
PHU BAI	(73)	(868)	(941)
DONG HA	(35)	(703)	(738)
SU #1, 1ST ANGLICO (AT VARIOUS LOCATIONS SVN)	((21))	((191))	((212))
OTHER USMC PERSONNEL	159	149	308
MACV STAFF/MACV FIELD	(136)	(136)	(272)
NAVAWGRU/NAVY UNITS	(23)	(13)	(36)
USMC IN RVN CHARGED AGAINST PROGRAM VIII	3,644	48,931	52,575
U. S. NAVY, III MAF.	256	1,784	2,040

* AS REPORTED BY III MAF DAILY ADMIN SITREP #42 AS OF 2400, 10FEB70
AND THE MACV WEEKLY STRENGTH REPORT, AS OF 2400, 12FEB70 AS ADJUSTED
BY MACV DAILY RPT OF ARR/DEP AS OF 2400, 13FEB70.

Unclassified
UNCLASSIFIED

~~SECRET~~

WESTPAC UNIT LOCATIONS

16 FEBRUARY 1970

QUANG TRI (QUANG TRI)

USMC 738
USN 37
USA 5,826

- 1ST BDE, 5TH INF DIV (MECH)
1/77 ARMOR (OPN GREENE RIVER)
1/61 INF (MECH) (OPN GREENE RIVER)
1/11 INF (OPN GREENE RIVER)
3/5 ARMD CAV SQDN (OPN GREENE RIVER)

THUA THIEN

HQ, XXIV CORPS (PHU BAI)

HQ, 101st ABN DIV (AM)

- 1ST BDE, 101ST ABN DIV (AM)
1/327 INF (AM) (OPN RANDOLPH GLEN)
2/327 INF (AM) (OPN RANDOLPH GLEN)
2/502 INF (AM) (OPN RANDOLPH GLEN)

- 2D BDE, 101ST ABN DIV (AM)
1/501 INF (AM) (OPN RANDOLPH GLEN)
2/501 INF (AM) (OPN RANDOLPH GLEN)
1/502 INF (AM) (OPN RANDOLPH GLEN)

- 3D BDE, 101ST ABN DIV (AM)
1/506 INF (AM) (OPN RANDOLPH GLEN)
2/506 INF (AM) (OPN RANDOLPH GLEN)
3/187 INF (AM) (OPN RANDOLPH GLEN)

USMC 941
USN 46
USA 16,259

1st MAW
MAG-16
HML-367 (UH-1E)

QUANG NAM

HQS 1ST MAR DIV (DANANG)

1ST MARINES

- 1/1
2/1
3/1

5TH MARINES

- 1/5
2/5
3/5

7TH MARINES

- 1/7
2/7
3/7

26TH MARINES

- 1/26
2/26
3/26

HQS, III MAF

USMC 45,373
USN 1,841
USA 1,110
ROKMC 7,145

HQ 1st MAW
MAG-11

- VMA(AW)-242 (A-6A)
VMA(AW)-225 (A-6A)
VMCJ-1 (RF-4/EA-6/EF-10)
VMO-2 (AH-1G/OV-10A)

- MAG-16 () (UH-1E)
HML-167 (CH-53A)
HMH-463 (CH-46D)
HMM-364 (CH-46D)
HMM-263 (CH-46D)
HMM-262 (CH-46D)
HMM-161 (CH-46D)

2d ROKMC BDE

- 1/2 (OPN VICTORY DRAGON XIX)
2/2 (OPN VICTORY DRAGON XIX)
3/2 (OPN VICTORY DRAGON XIX)
5/2 (OPN VICTORY DRAGON XIX)

FLC 1ST FSR/FLSG-B/1ST SERV BN

QUANG TIN/QUANG NGAI

HQ 23d INF DIV (AMERICAL) (CHU LAI)

196TH LT INF BDE

- 2/1 INF (OPN FREDERICK HILL)
4/31 INF (OPN FREDERICK HILL)
3/21 INF (OPN FREDERICK HILL)
1/46 INF

198TH LT INF BDE

- 1/6 INF (OPN GENEVA PARK)
1/52 INF (OPN GENEVA PARK)
5/46 INF (OPN NANTUCKET BEACH)

11TH INF BDE

- 1/20 INF (OPN IRON MOUNTAIN)
4/21 INF (OPN IRON MOUNTAIN)
3/1 INF (OPN IRON MOUNTAIN)
4/3 INF (OPN IRON MOUNTAIN)
1/1 ARMD CAV SQDN (OPN IRON MOUNTAIN)

1st MAW

- MAG-12 (A-4E)
VMA-211 (A-4E)
VMA-311 (A-4E)

- MAG-13
VMFA-115 (F-4B)
VMFA-314 (F-4B)
VMFA-122 (F-4B)

USMC 5,215
USN 116
USA 24,391

OKINAWA

HQ, I MEF
3D MAR DIV (-)(REIN)(TF-79)
11th MEB (TF-79.1)

OSD PROGRAM VIII CEILING

USMC 19,200
USN 934

ACTUALS CHARGED AGAINST
PROGRAM VIII AS OF 5FEB70..

18,580 424

4TH MARINES

- 1/4
2/4
3/4

9TH MARINES

- 3/9

MAG-36

- VMGR-152 (KC-130F)
VMO-6 (OV-10A/UH-1E)
HMH-462 (CH-53A)

14,061 (349)

- 3D FSR (3,456) (50)
MCB CAMP BUTLER/NON FMF (913) (25)
Non-Deployable Casuals (148)
SVN-Originated Patients (0)

USMC RVN RECAP

	USMC	USN
OSD PROGRAM VIII CEILING	55,510	2,233
ACTUALS CHARGED AGAINST PROGRAM VIII AS OF 13FEB70	52,575	2,040
III MAF	52,267	2,040
SU#1 1ST ANGLICO	(212)	(14)
OTHER	308	(272)
MACV STAFF/MACV FIELD	(272)	
NAVAIDVGRU/NAVY UNITS	(36)	

I CORPS RECAP

US MARINE CORPS	(12 BNs)	52,267
US ARMY	(25 BNs)	73,849
US NAVY		16,954
US AIR FORCE		8,194
ROKMC	(4 BNs)	6,148
RVNAF	(36 BNs)	153,895
ARVN/ABN	(36 BNs)	(74,634)
VNMC		(2,100)
VNN		(3,408)
VNAF		(37,403)
VNRF		(36,350)
VNPF		

I CORPS TOTAL 77 BNs 311,307

SLF 7TH FLEET

	USMC	USN
BRAVO: BLT 2/9 HMM-165 AT TAIWAN	1,847	60
ALFA: BLT 1/9 HMM-164 AT OKINAWA	1,868	85

MOVEMENTS

Det 12th Mar and "D" Co, 3d Recon Bn.
At Fuji for training.

JAPAN

	USMC	USN
OSD PROGRAM VIII CEILING	3,600	45
ACTUALS CHARGED AGAINST PROGRAM VIII AS OF 5FEB70.	3,749	34
1ST MAW (REAR)		
MAG-15	(2,553)	(34)
VMFA-232 (F-4J)		
VMFA-334 (F-4J)		
VMA(AW)-533 (A-6A)		

*Does NOT include 243 hospitalized
SVN-Originated Patients.

Non FMF (1,196)

* Includes only U. S. Navy Personnel organic to FMF Units.
Includes SU#1 and 1st ANGLICO at various locations throughout SVN.
• Latest Change

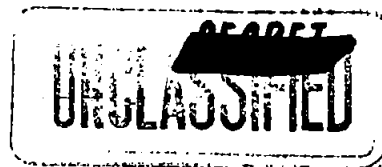



MARINE CORPS

FEB 16 1970

REFERENCE BRANCH

Unclassified



UNCLASSIFIED

SUMMARY OF MAJOR RVNAF OPERATIONS

OPERATION (DATE COMMENCED)	UNITS INVOLVED	LOCATION	CASUALTIES AS OF: 162400H FEB70		
			FRIENDLY		ENEMY
			KIA	WIA	KIA
LAM SON 350 (1JAN70)	2ND REGT: 1/2, 2/2, 3/2, 4/2 & 5/2	5 KM E OF GIO LINH	17	22	170
LAM SON 353 (1JAN70)	7TH CAV: 3/7 CAV	5 KM SE OF GIO LINH	4	19	28
LAM SON 354 (6JAN70)	54TH REGT: 3/54	6 KM S OF QUANG TRI CITY	1	3	1
LAM SON 352 (1JAN70)	54TH REGT: 1/54, 2/54 & 4/54	2 KM NW OF PHU BAI	1	6	29
LAM SON 349 (1JAN70)	1ST REGT: 1/1, 2/1, 3/1 & 4/1	21 KM NW OF A LUOI	11	36	143
LAM SON 351 (1JAN70)	3RD REGT: 1/3, 2/3, 3/3 & 4/3	25 KM SW OF HUE	5	10	42
HUNG QUANG 1/22 (12JAN70)	51ST REGT: 1/51	16 KM NW OF HOI AN	NONE	10	3
QUYET THANG 54 (2JAN70)	5TH REGT: 1/5, 2/5, 4/5 & 4/6	12 KM W OF TAM KY	18	64	172
DUONG SON 3/70 (11FEB70)	1ST ARM BDE: 37TH & 39TH RGR BNS & 3/17 ACAT	30 KM NW OF TAM KY	25	67	240
PHU DONG 401 (11FEB70)	2D BN 6TH REGT: 2/6, 1/4 & 2/4 ACAT	12 KM SW OF QUANG NGAI CITY	NONE	NONE	NONE
QUYET THANG 63 (2JAN70)	6TH REGT: 1/6 & 3/6	18 KM NW OF QUANG NGAI CITY	20	87	130
QUYET THANG 45 (4JAN70)	4TH REGT: 1/4, 2/4, 3/4 & 4/4	11 KM SW OF DUC PHO	19	53	267

ALL UNITS ARE ARVN UNLESS DESIGNATED
 * - ADJUSTED
 # - FINAL CUMULATIVE CASUALTIES

UNCLASSIFIED

Unclassified

~~SECRET~~

SUMMARY OF MAJOR US AND FWMAF OPERATIONS

OPERATION (DATE COMMENCED)	UNITS INVOLVED	LOCATION	CASUALTIES AS OF: 162400H FEB70		
			FRIENDLY		ENEMY
			KIA	WIA	KIA
GREENE RIVER (19JAN70)	1ST BDE, 5TH INF DIV (MECH); 4 USA BNS	EASTERN QUANG TRI PROVINCE	4	106	58
RANDOLPH GLEN (7DEC69)	101ST ABN DIV (AM); 9 USA BNS	QUANG TRI & THUA THIEN PROVINCES	58	260	412
VICTORY DRAGON XIX (1JAN70)	2D ROKMC BDE; 4 ROKMC BNS	HOI AN AREA	1	12	9
FREDERICK HILL (18MAR69)	196TH INF BDE: 3 USA BNS	QUANG TIN PROVINCE	370	2,335	4,491
GENEVA PARK (18JUL69)	198TH INF BDE: 2 USA BNS	QUANG TIN & QUANG NGAI PROVINCES	126	858	1,155
NANTUCKET BEACH (20JUL69)	198TH INF BDE: 1 USA BN	CENTERED 15 KM NE OF QUANG NGAI CITY	24	217	250
IRON MOUNTAIN (18MAR69)	11TH INF BDE: 5 USA BNS	QUANG NGAI PROVINCE	288	1,671	2,493

* - ADJUSTED
- FINAL CUMULATIVE CASUALTIES

~~SECRET~~
UNCLASSIFIED

Unclassified

UNCLASSIFIED

MARINE CORPS COMMAND CENTER

USMC/ENEMY CASUALTIES IN RVN

16 FEBRUARY 1970

USMC BATTLE CASUALTIES

KIA/DOW	WIA(EVAC)	WIA(RTD)	MIA/PW
12,450	48,819	35,794	80/21

USMC CASUALTY FIGURES ARE PROVIDED DAILY BY HQMC CASUALTY SECTION (CODE DNA) AND REFLECT ALL CASUALTIES REPORTED AS OF 12 FEB 70.

USMC NON-BATTLE CASUALTIES

DEAD	INJURED	MISSING
1,505	1,822	12

FIGURES INDICATED AS INJURED ARE ONLY THOSE IN SERIOUS/CRITICAL INJURY OR DISEASE CATEGORY AND DO NOT INCLUDE THOSE OF A MINOR NATURE

USMC INFLECTED ENEMY CASUALTIES

KIA	PW	WPNS
80,560	4,198	20,807

ENEMY CASUALTIES ARE COMPILED DAILY FROM THE III MAF HISSUM AND ARE RECONCILED MONTHLY WITH THE FMFPAC SUMMARY OF USMC OPERATIONS IN RVN

TYPICAL DISPOSITION OF 100 USMC WIA *

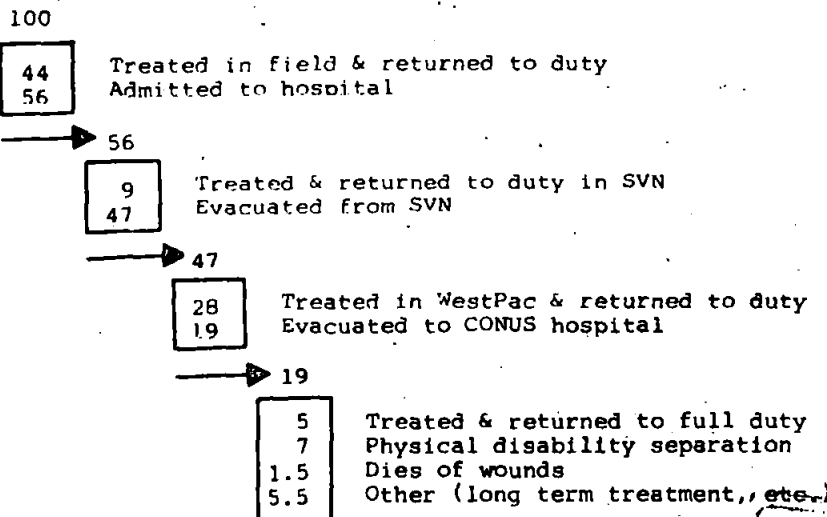

*54,081 CASUALTIES, JAN67-DEC68.

UNCLASSIFIED
Unclassified

UNCLASSIFIED

16 FEBRUARY 1970

MARINE CORPS COMMAND CENTER

MILITARY FORCES IN RVN *

RVN ARMED FORCES (RVNAF)

ARMY (ARVN)	416,278
NAVY (VNN)	30,143
AIR FORCE (VNAF)	36,469
MARINE CORPS (VMMC)	11,528
REGIONAL FORCES (RF)	260,455
POPULAR FORCES (PF)	214,383
TOTAL RVNAF	969,256

UNITED STATES FORCES

ARMY	333,615
NAVY	29,128
AIR FORCE	56,553
MARINE CORPS	52,575
COAST GUARD	369
TOTAL U.S.	472,240

FREE WORLD MILITARY ASSISTANCE FORCES (FWMAF)

REPUBLIC OF KOREA	48,871
AUSTRALIA	7,696
PHILIPPINES	142
THAILAND	11,568
NEW ZEALAND	557
REPUBLIC OF CHINA	28
SPAIN	11
TOTAL FWMAF	68,873

TOTAL FORCES IN RVN 1,510,369

SOURCE: RVNAF MACV MONTHLY STRENGTH REPORT. ALL OTHER:
MACV WEEKLY STRENGTH REPORT AS OF 2400, 12FEB70.
USMC STRENGTH: MACV WEEKLY STRENGTH REPORT AS
ADJUSTED BY MACV RPT OF ARR/DEP AS OF 2400, 13FEB70.

UNCLASSIFIED
Unclassified
~~CONFIDENTIAL~~

VIETNAM REFERENCE DATA

16 FEBRUARY 1970

UNCLASSIFIED

SELECTED ENEMY WEAPONS RANGES

		METERS	YARDS
CHICOM	60mm mortar	1566	1700
SOVIET	82mm mortar	3040	3320
SOVIET	120mm mortar	5700	6235
SOVIET	102mm rocket	5030	5500
CHICOM	107mm rocket	7875	9000
SOVIET	122mm rocket	10800	12000
SOVIET	140mm rocket	8800	9750
SOVIET	200mm rocket	20300	22200
SOVIET	250mm rocket	55900	61000
SOVIET	76mm field gun	13300	14550
SOVIET	85mm field gun	15650	17100
SOVIET	100mm field gun	21000	22900
U. S.	105mm howitzer	11000	12030
SOVIET	122mm gun/how	15300	16740
SOVIET	122mm field gun	21900	24000
SOVIET	130mm field gun	27000	29500
SOVIET	152mm gun/how	17200	18000

MARINE TOUR/EXTENSION IN RVN DATA*

	OFF	ENL	TOTAL
VOLUNTARY EXTENSIONS FOR 6 MONTHS OR LONGER SINCE JUNE 1966	881	40,428	41,309
SERVING ON SECOND TOUR OF DUTY IN RVN SINCE MARCH 1965			
VOLUNTARY	142	811	953
INVOLUNTARY	0	3	3

SOURCE: CG FMFPAC 142308Z FEB70 (AS OF 31JAN70)

COMBINED ACTION UNIT STATISTICS PERIOD 1-31 DEC 69

FRIENDLY LOSSES:			KIA	WIA	ENEMY LOSSES:				
					KIA	PW/DET	RET	WPNS	
USMC	4	62			90	35/184	30	65	
USN	0	2							
PF	6	41							
TOTAL UNITS									
	OFF	USMC	ENL	USN	PF	RF	CAG	CAC	CAP
STRENGTH:	44	1,666		119	2,991	41	4	20	114

UNCLASSIFIED

UNCLASSIFIED

LANDING FORCE, SIXTH FLEET 3-69

10 FEBRUARY 1970

UNITS EMBARKED TF-61/62 CTG: LTCOL G. B. CRIST	STRENGTH				ARMS & EQUIPMENT	LOCATION AT NAVPLION GREECE.
	USMC		USN			
	OFF	ENL	OFF	ENL		
BLT 2/6 (LTCOL G. B. CRIST)					31 7.62 MG 10 LVTP-5	SHIPPING USS CAMBRIA (APA-36) USS LASALLE (LPD-3) USS RUSHMORE (LSD-14) USS WAHKIAKUM (LST-1162)
2D BN, 6TH MAR	49	1030	4	33	6 105 HOW 5 90MM GUN TANK 5 ONTOS 8 81MM MORTARS 8 FLAME THROWERS 6 106MM RR	
DET HQCO, 6TH MAR					21 MULES 32 MITES	SUPPLIES CLASS I CLASS II CLASS III CLASS IV CLASS V
BTRY "E", 2/10	9	124			22 2 1/2 TON TRUCKS 8 JEEPS	
DET HQ BTRY, 2/10	2	10		2	3 5 TON CARGO TRUCKS 9 3/4 TON UTIL TRUCKS	
PLT CO "C", 2D AMTRAC BN	1	45			4 AMBULANCES 4 CRANES	
PLT CO "B", 8TH MT BN		19				
PLT CO "C", 2D AT BN	1	21				
PLT CO "B", 2D ENGR BN		49				
PLT CO "A", 2D MED BN		10	1	9		
PLT CO "A", 2D TK BN	1	24				
PLT CO "A", 2D SP BN	1	49				
PLT CO "B", 2D RECON BN	1	24		1		
DET HQBN, 2D MARDIV		27				
DET 2D DENTAL CO			2	2		
DET 2D SERVICE BN	1	42				
DET 2D FSR		40				
TOTALS	66	1514	7	47	AIRCRAFT NO AIRCRAFT	

LANDING FORCE, CARIBBEAN 1-70

16 FEBRUARY 1970

UNITS EMBARKED TASK GROUP 45.9 CTG: COL G. R. HUNTER	STRENGTH				ARMS & EQUIPMENT	LOCATION ENR LIBERTY PORTS. ETA 20FEB70.
	USMC		USN			
	OFF	ENL	OFF	ENL		
HQ 36TH MEU					11 LVTP-5 5 M48 TANK 5 M50 ONTOS 6 105MM HOW TD 8 106MM RR 8 81MM MORTAR	SHIPPING USS GUADALCANAL (LPH-7) USS VERMILLION (LKA-107) USS SUFFOLK CTY (LST-1173) USS SPEIGEL GROVE (LSD-32)
BLT 3/2 (LTCOL E. F. PIERSON JR.)						
3D BN, 2D MARINES	44	1007	4	38		SUPPLIES CLASS I CLASS II CLASS III CLASS IV CLASS V
BTRY "I", 3/10	10	136	1	2		
DET HQ BTRY, 3/10						
PLT CO "B", 2D AMTRAC BN	1	40				
PLT CO "C", 2D MT BN	1	33				
PLT CO "A", 2D AT BN	1	21				
PLT CO "A", 2D ENGR BN	1	49				
PLT H&S CO, 2D MED BN		10		17		
PLT CO "A", 2D TANK BN	1	24				
PLT CO "A", 2D SP BN	1	52		7		
PLT CO "C", 2D RECON BN	1	23		1		
DET HQBN, 2D MARDIV	1	25				
DET 2D DENTAL CO			1	1		
DET 2D SERV BN	1	40				
DET 2D FSR	1	37				
DET HQCO, 2D MARINES		20				
HMM-261 (LTCOL V. M. HAZELBAKER)	43	170	1			
TOTALS	107	1687	7	61	AIRCRAFT 19 CH-46D	

UNCLASSIFIED

~~CONFIDENTIAL~~
UNCLASSIFIED

FLEET MARINE FORCE DEPLOYMENTS

17 FEBRUARY 1970

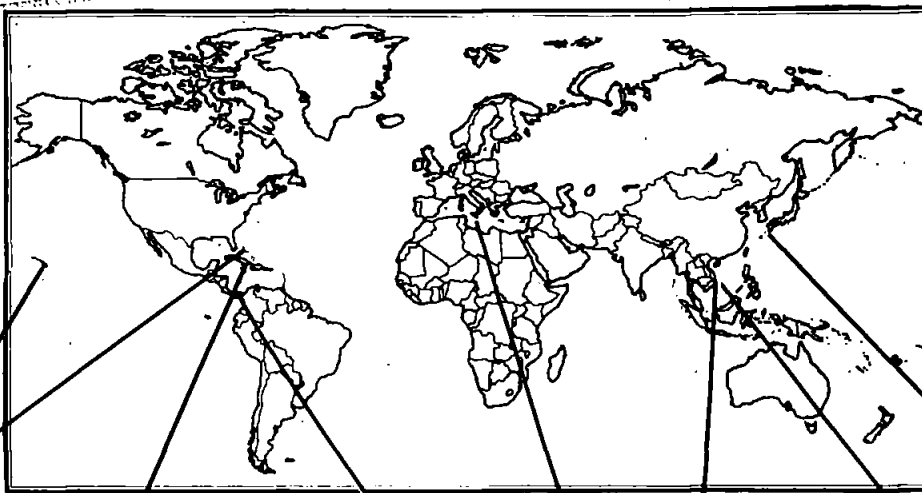

1ST MAR BRIG
HAWAII

DET HJBN 10TH MAR
DET 1/10
DET 2/10
DET 3/10
DET 4/10
DET 2D FAG
DET 1, HMM 264
ENR VIEQUES FOR FIREX

GINO AUGMENT

2D BN, 8TH MAR
BRY B/1/10
PLT 2D TK BN
PLT 2D ANGLICO
DET FSR

LANFORCARIB 1-70

BLT 3/2 & HMM-261
ENR LIBERTY PORTS
ETA 20FEB70

LANFOR6THFLT 3-69

AT NAVPLION
GREECE

III MAF

RVN

SLF, 7TH FLEET

SLF BRAVO
ENR SUBIC BAY
ETA: 22FEB70

I MEF

OKINAWA
& JAPAN

DET 12TH MAR "D" CO,
3D RECON BN AT FUJI
FOR TRNG.

SLF ALFA
AT OKINAWA

DISTRIBUTION OF MAJOR FMF UNITS

	INF BNS	VMFA	VMA	VMA(AW)	VMCI	BMM	RMF	BML	VMO	VMGR
WESTPAC	18	5	2	3	1	6	2	2	2	1
RVN	(12)	(3)	(2)	(2)	(1)	(4)	(1)	(2)	(1)	
OKINAWA/JAPAN	(4)	(2)		(1)			(1)		(1)	(1)
ASSIGNED TO SLF	(2)					(2)				
MIDPAC	1	2								
HAWAII	(1)	(2)								
AFLOAT										
EASTPAC	2	* 3	2		1	2	2	1		1
WEST COAST	(2)	(3)	(2)		(1)	(2)	(2)	(1)		(1)
AFLOAT										
ATLANTIC	8	5	2	3	1	4	2		1	1
EAST COAST	(6)	(5)	(2)	(3)	(1)	(3)	(2)		(1)	(1)
CARIBBEAN	(2)					(1)				
EUROPE	1									
MEDITERRANEAN	(1)									
GRAND TOTAL	30	15	6	6	3	12	6	3	3	3

* CAPRE

~~CONFIDENTIAL~~
UNCLASSIFIED

SELECTED UNIT COMMANDERS AND STAFF OFFICERS

17 FEBRUARY 1970

UNCLASSIFIED

HEADQUARTERS FLEET MARINE FORCE PACIFIC

COMMANDING GENERAL	LTGEN H. W. BUSE, JR.
DEPUTY COMMANDER	MGEN P. J. FONTANA
CHIEF OF STAFF	BGEN L. H. WILSON
ACOS, G-1	COL F. S. WOOD
ACOS, G-2	COL J. F. MITCHELL
ACOS, G-3	COL R. M. HALL
ACOS, G-4	COL J. B. SOPER
ACOS, G-5	LTCOL E. L. HICKAM

5TH MARINE EXPEDITIONARY BRIGADE

COMMANDING GENERAL	BGEN R. T. DWYER, JR.
ADC	
CHIEF OF STAFF	COL M. W. SCHMIDT
ACOS, G-1	COL E. R. DAZE
ACOS, G-2	MAJOR J. D. LITTLE
ACOS, G-3	COL J. P. KELLY
ACOS, G-4	COL G. R. STURDIVAN
HQ BN	LTCOL J. F. HEL
H&SCO	MAJ J. A. LINNEMANN
<u>3RD MARINES</u>	
COMMANDING OFFICER	COL W. A. BUTCHER
2ND BATTALION	LTCOL E. Z. GRABOWSKI
3RD BATTALION	LTCOL J. G. COLLIER
1STBN, 12THMAR	LTCOL J. F. HELSEL
M BTRY, 4THBN, 12THMAR	
CoA, 3D AT BN	CAPT C. W. FATTIG
CoA, 3D RECON BN	CAPT R. E. FIELDS, JR.
CoB, 3D ENGR BN	CAPT A. A. LOPEZ
CoB, 3D MT BN	CAPT M. A. SELBY
Co B, 3D SP BN	MAJ B. E. MACHA
Co D, 3D TANK BN	CAPT W. J. DIBELLO
DET, 3D SERVICE BN	COL G. K. REID
COMM SPT CO, 9TH COMM BN	MAJ W. B. LUDWICK
Co B, 11TH ENGR BN	CAPT H. L. CAMPBELL
Co B, 9TH MT BN	CAPT C. D. GARRETT
Co A, 1ST AMTRAC BN	MAJ R. G. JONES
1ST SEARCHLIGHT BTRY	CAPT K. C. KALBFLEISCH
9TH SEP BULK FUEL CO	MAJ M. E. MC PHERSON
3D BRIDGE CO	CAPT J. P. MEREDITH
1ST ARMD AMPHIB CO	MAJ R. D. DASCH
1ST CIVIL AFFAIRS GROUP	COL R. M. TAYLOR
3D HOSP CO	LT E. J. CARLISLE (USN)
Co C, 3D MED BN	LT D. B. COOLIDGE (USN)
DET#2, 5TH DENT CO	CAPT J. A. KOCH (USN)

1ST MARINE BRIGADE

COMMANDING OFFICER	COL B. G. CASS
S-1	LTCOL W. H. WAHFELD
S-2	CWO P. B. MURPHY
S-3	LTCOL J. R. W. COCHRAN
S-4	LTCOL E. L. CONROY
H&SCO	MAJ J. G. HANRAHAN
1ST BN, 3D MARINES	LTCOL D. J. HUNTER
<u>MAG-24</u>	
COMMANDING OFFICER	COL K. C. PALMER
H&MS-24	LTCOL W. H. HEINTZ
M&BS-24	LTCOL A. B. COLBERT
M&CS-2	LTCOL R. D. MILLER
VMFA-212	LTCOL H. H. ZIEGLER
VMFA-235	LTCOL L. A. MAIERA
MATCU-70	MAJOR H. B. VERGARA
SU#2, 1ST RAD BN	MAJOR L. K. RUSSELL
DET#1, 5TH DENT CO	CIR J. D. CRAWFORD

FORCE TROOPS FMFPAC

COMMANDING GENERAL	BGEN C. W. HOFFMAN
ASSISTANT COMMANDER	COL A. B. CLARK
CHIEF OF STAFF	COL L. N. UTTER
ACOS, G-1	LTCOL D. K. GRAY
ACOS, G-2	1STLT R. COOK
ACOS, G-3	LTCOL W. R. MILLER, JR.
ACOS, G-4	LTCOL M. E. FARMER
<u>3RD FORCE SERVICE REGT</u>	
COMMANDING OFFICER	COL J. R. JONES
H&S BATTALION	LTCOL J. B. HARRIS
SUPPLY BATTALION	LTCOL H. G. FISCHER
MAINT BATTALION	LTCOL L. I. FEIN
<u>5TH FORCE SERVICE REGT</u>	
COMMANDING OFFICER	COL K. W. HENRY
H&S BATTALION	MAJOR J. A. SHEARMAN, JR.
SUPPLY BATTALION	LTCOL M. E. STEIN
MAINT BATTALION	LTCOL J. M. HERMES
13TH MT BATTALION	MAJOR T. M. COLLINS
9TH COMM BATTALION	LTCOL G. W. HOUCK

UNCLASSIFIED

SELECTED UNIT COMMANDERS AND STAFF OFFICERS

UNCLASSIFIED

17 FEBRUARY 1970

HEADQUARTERS III MARINE AMPHIBIOUS FORCE

COMMANDING GENERAL	LTGEN H. NICKERSON, JR.
DEPUTY COMMANDER	MGEN G. S. BOWMAN, JR.
CHIEF OF STAFF	BGEN L. J. DULACKI
DEPUTY CHIEF OF STAFF	COL S. A. DRESSIN
ACOS, G-1	COL R. L. PARNELL, JR.
ACOS, G-2	COL E. W. DZIALO
ACOS, G-3	BGEN T. H. MILLER, JR.
ACOS, G-4	COL W. F. SIMLIK
ACOS, G-5	COL C. J. PEABODY
ACOS, G-6	LTCOL R. S. BARRY
ACOS, COMPT	LTCOL J. M. VOSMIK
DEP C/S SPECIAL PROJECTS	COL A. T. WOOD

CG XXIV CTZ	LTGEN M. ZAIS USA
DEP C/S XXIV CTZ	COL M. M. COOK USMC

ACOS, CAP	COL T. E. METZGER
COMMANDING OFFICER, 1ST CAG	LTCOL D. F. SEILER
COMMANDING OFFICER, 2ND CAG	LTCOL D. R. CHRISTENSEN
COMMANDING OFFICER, 3RD CAG	LTCOL C. M. DANIELS
COMMANDING OFFICER, 4TH CAG	LTCOL J. J. KEENAN
1ST RADIO BATTALION	LTCOL D. M. HOPKINS

1ST MARINE DIVISION

COMMANDING GENERAL	MGEN E. B. WHEELER
ADC	BGEN W. F. DOEHLER
ADC	BGEN C. S. ROBERTSON
CHIEF OF STAFF	COL C. E. WALKER
ACOS, G-1	COL R. E. BARDE
ACOS, G-2	COL E. A. WILCOX
ACOS, G-3	COL F. H. WALDROP
ACOS, G-4	COL N. A. CANZONA
ACOS, G-5	COL L. S. HULLIER
ACOS, COMPT	LTCOL N. M. LASLAVIC, JR.
CEO	COL C. G. DAHL

1ST MARINES

COMMANDING OFFICER	COL E. A. WILCOX
1ST BATTALION	LTCOL G. S. DELCUZE
2ND BATTALION	LTCOL W. V. H. WHITE
3RD BATTALION	LTCOL F. M. BOYD

5TH MARINES

COMMANDING OFFICER	COL R. F. ESTEY
1ST BATTALION	LTCOL J. K. GRIFFIS, JR.
2ND BATTALION	LTCOL F. LEDER
3RD BATTALION	LTCOL J. S. GESTSON

7TH MARINES

COMMANDING OFFICER	COL G. S. CODISPOTI
1ST MARINES	LTCOL C. G. COOPER
2ND MARINES	LTCOL A. E. FOLSOM
3RD MARINES	LTCOL R. G. KUMMEROW

26TH MARINES

COMMANDING OFFICER	COL J. E. HARRELL
1ST BATTALION	LTCOL J. C. GOODIN
2ND BATTALION	LTCOL P. L. HUMPHREY
3RD BATTALION	LTCOL J. J. UNTERKOPFLER

11TH MARINES

COMMANDING OFFICER	COL D. D. EZELL
1ST BATTALION	LTCOL J. D. SHOUP
2ND BATTALION	LTCOL V. WEAVER
3RD BATTALION	LTCOL K. N. MUELLER
4TH BATTALION	LTCOL J. F. BURKE, JR.

1ST BN, 13TH MAR	LTCOL D. H. STRAIN
------------------	--------------------

HQS BATTALION	COL W. C. PATTON
---------------	------------------

1ST ENGR BATTALION	LTCOL N. F. GLOWICKI
1ST RECON BATTALION	LTCOL W. C. DRUMWRIGHT
1ST MT BATTALION	LTCOL M. S. SHIMANOFF
1ST SP BATTALION	COL R. F. ARMSTRONG
1ST MED BATTALION	CAPT(MC) J. W. LEA
1ST TK BATTALION	MAJOR J. I. LOUDER
3RD AMTRAC BATTALION	LTCOL D. G. MEHARGUE
7TH ENGR BATTALION	LTCOL W. G. BATES
9TH ENGR BATTALION	LTCOL E. K. MAXWELL
11TH MT BATTALION	LTCOL W. R. KEPHART

FORCE LOGISTICS COMMAND

COMMANDING GENERAL	BGEN M. J. PADALINO
CHIEF OF STAFF	COL J. L. TOBIN
ACOS, G-1	LTCOL J. E. REDELFS
ACOS, G-2	LTCOL R. L. SOLZE
ACOS, G-3	LTCOL W. W. STORM, III
ACOS, G-4	LTCOL M. H. IVINS
ACOS, G-5	MAJOR R. E. JOHNSON
ACOS, COMPT	LTCOL F. R. WARREN
CEO	MAJOR R. D. HAGAN

1ST FORCE SERVICE REGT

H&S BATTALION	LTCOL L. R. WEBB
SUPPLY BATTALION	COL R. W. CALVERT
MAINT BATTALION	LTCOL E. C. MORRIS

FLSG-B/1ST SERV BN	COL D. E. MORIN
5TH COMM BATTALION (REIN)	LTCOL D. E. SHATZER
7TH MT BATTALION	LTCOL R. L. PRATHER
1ST MP BATTALION	LTCOL S. D. THOMAIDIS
3RD MP BATTALION	LTCOL C. FIMIAN

UNCLASSIFIED

UNCLASSIFIED

SELECTED UNIT COMMANDERS AND STAFF OFFICERS

17 FEBRUARY 1970

1ST MARINE AIRCRAFT WING		3D MARINE AIRCRAFT WING	
COMMANDING GENERAL AWC	MGEN W. G. THRASH	COMMANDING GENERAL AWC	MGEN R. G. OWENS, JR.
CHIEF OF STAFF	BGEN R. H. SPANJER	CHIEF OF STAFF	BGEN J. A. FEELEY, JR.
ACOS, G-1	COL R. W. TELLER	ACOS, G-1	COL H. N. MEHAFFEY
ACOS, G-2	COL G. S. STEWART	ACOS, G-2	LTCOL L. A. GULLING
ACOS, G-3	COL J. R. WEAVER	ACOS, G-3	COL R. J. GRAHAM
ACOS, G-4	COL R. L. LAMAR	ACOS, G-4	COL D. WILKER
ACOS, COMPT	COL W. C. MCCRAW		
CEO	COL E. J. ARTNAK		
	LTCOL T. KALUS		
<u>MWHG-1</u>		<u>MWHG-3</u>	
COMMANDING OFFICER	COL L. J. STIEN	COMMANDING OFFICER	COL G. L. LILLICH
H&MS-1	MAJ W. S. HUMBERT	H&MS-3	LTCOL J. B. LAVELLE
MWFS-1	LTCOL N. F. SCHNIPPEL, JR.	MWFS-3	MAJOR J. S. LOOP
MWCS-1	MAJOR A. B. RAY	MWCS-3	MAJOR D. B. NEWTON
<u>MWSG-17</u>		<u>MHTG-30</u>	
COMMANDING OFFICER	COL H. L. JENSEN	COMMANDING OFFICER	COL A. F. GARROTTO
H&MS-17	LTCOL D. SERRIN	H&MS-30	LTCOL R. W. CREIGHTON
WERS-17	MAJOR W. F. FARLEY	HMMT-301	LTCOL L. W. JARMAN
		HMMT-302	LTCOL K. D. VANEK
<u>MACG-18</u>		<u>MAG-33</u>	
COMMANDING OFFICER	COL S. G. DUNWIDDIE, JR.	COMMANDING OFFICER	COL F. N. PIPPIN
H&MS-18	LTCOL H. E. HOPPMEYER, JR.	H&MS-33	LTCOL R. H. HUTCHINSON
MACS-4	LTCOL R. W. MOLYNEUX, JR.	MABS-33	MAJOR J. E. KEHRLE
		VMCJ-3	LTCOL R. E. PERCIVAL
MASS-3	LTCOL J. H. DUBOIS	VMA-214	LTCOL W. R. SMITH
		VMFA-323 (CADRE)	MAJ K. A. ZIMMERMAN II
<u>MAG-11</u>		VMFAT-101	LTCOL R. R. NORTON
COMMANDING OFFICER	COL N. E. HEFFERNAN	VMFA-531	LTCOL J. L. THATCHER
H&MS-11	LTCOL R. F. HEBERT	VMFA-542	LTCOL K. A. SMITH
MABS-11	LTCOL P. A. MANNING	VMA-223	LTCOL J. W. IAZZO
VMCJ-1	LTCOL B. W. FARLEY		
VMA(AW)-225	LTCOL J. J. METZKO	<u>MWSG-37</u>	
VMA(AW)-242	LTCOL S. P. LEWIS	COMMANDING OFFICER	COL F. E. WILSON
VMO-2	LTCOL J. M. MORIARITY	H&MS-37	LTCOL D. L. RICE
		WERS-37	LTCOL R. W. DUPHINEY
<u>MAG-12</u>		VMGR-352	LTCOL H. D. STOTT
COMMANDING OFFICER	COL P. B. HENLEY	<u>MACG-38</u>	
H&MS-12	LTCOL J. J. WENT	COMMANDING OFFICER	LTCOL T. I. GUNNING
MABS-12	LTCOL G. J. ERTLMEIR	H&MS-38	MAJOR F. L. HARDING
VMA-311	MAJOR A. R. HICKLE	SU#1, H&MS-38	MAJOR D. V. STOWELL
VMA-211	LTCOL L. GASPERINE, JR.	MACS-1	MAJ C. F. KELLENBARGER
VMA-223	LTCOL J. W. IAZZO	MACS-3	LTCOL T. M. KAUFFMAN
		MACS-7	LTCOL D. E. ROBERTS
<u>MAG-13</u>		1STLAAM BN	MAJOR E. L. HOUSE, JR.
COMMANDING OFFICER	LTCOL T. E. MURPHREE	2NDLAAM BN	MAJOR H. J. BALDWIN, JR.
H&MS-13	MAJOR F. J. HORACK		
MABS-13	MAJOR R. D. REVIE	<u>MAG-56</u>	
VMFA-115	LTCOL D. P. BOWEN	COMMANDING OFFICER	COL M. D. PORTER
VMFA-314	LTCOL T. J. KELLY	H&MS-56	LTCOL G. H. BUCKNER II
VMFA-122	LTCOL R. E. HOWARD, JR.	MABS-56	LTCOL F. L. YOHE
		HMH-363	LTCOL R. P. BRAY
<u>MAG-16</u>		HML-267	LTCOL J. M. BLANC
COMMANDING OFFICER	COL J. P. BRUCE	HMH-361	LTCOL R. A. GOVONI
H&MS-16	MAJOR M. T. HORNSEY	HMM-163	LTCOL F. A. MATHEWS
MABS-16	LTCOL P. C. SCAGLIONE	HMM-265	LTCOL R. C. COURTNEY
		<u>MCCRTG-10</u>	
HMH-463	LTCOL C. A. BLOCK	COMMANDING OFFICER	COL G. FINK
HML-167	LTCOL J. E. WEBER	H&MS-10	MAJ I. L. DRIEFER
HMM-364	LTCOL C. R. DUNBAUGH	VMAT-102	LTCOL B. A. SCHAFFER
HMM-263	LTCOL W. R. LEDBETTER, JR.	VMT-103	LTCOL M. T. GARRISON
HMM-161	MAJOR B. H. MANN		
HMM-262	LTCOL R. A. BANCROFT		
HML-367	LTCOL W. G. CRETNEY		

UNCLASSIFIED

SELECTED UNIT COMMANDERS AND STAFF OFFICERS

17 FEBRUARY 1970

UNCLASSIFIED

HEADQUARTERS I MEF	
COMMANDING GENERAL	MGEN W. K. JONES
CHIEF OF STAFF	COL C. J. BAILEY, JR.
ACOS, G-1	MAJOR R. E. DOLAN
ACOS, G-2	LTCOL J. A. MACINNIS
ACOS, G-3	COL H. S. WILSON
ACOS, G-4	COL J. H. KEITH, JR.
CEO	LTCOL R. G. DEEM

3D MARINE DIVISION	1ST MAW (REAR)
<p>COMMANDING GENERAL ADC/CG 11TH MEB</p> <p>CHIEF OF STAFF ACOS, G-1 ACOS, G-2 ACOS, G-3 ACOS, G-4 ACOS, G-5 ACOS, COMPT CEO</p> <p><u>4TH MARINES</u> COMMANDING OFFICER 1ST BATTALION 2ND BATTALION 3RD BATTALION</p> <p><u>9TH MARINES</u> COMMANDING OFFICER 1ST BATTALION 2ND BATTALION 3RD BATTALION</p> <p><u>12TH MARINES (-)</u> COMMANDING OFFICER 2ND BATTALION 3RD BATTALION 4TH BATTALION</p> <p><u>SLF BRAVO</u> COMMANDER BLT 2/9 HMM-165</p> <p><u>SLF ALFA</u> COMMANDER BLT 1/9 HMM-164</p> <p>HQS BATTALION 3RD AT BATTALION 3RD ENGR BATTALION(-) 3RD RECON BATTALION(-) 3RD MT BATTALION (-) 3RD SP BATTALION (-) 3RD MED BATTALION 3RD TANK BATTALION(-) 7TH COMM BATTALION(-) 9TH MT BATTALION (-) 3RD SERV BATTALION (-) 11TH ENGR BATTALION 1ST AMTRAC BATTALION</p>	<p>COMMANDING GENERAL</p> <p>CHIEF OF STAFF ACOS, G-1 ACOS, G-2 ACOS, G-3 ACOS, G-4 ACOS, G-5 CEO</p> <p>H&HS-1 (REAR)</p> <p><u>MAG-15</u> COMMANDING OFFICER H&MS-15 MABS-15 VMFA-334 VMFA-232 VMA(AW)-533</p> <p><u>MAG-36</u> COMMANDING OFFICER H&MS-36 MABS-36</p> <p>VMGR-152 HMM-164 HMM-165 HMH-462 VMO-6</p> <p><u>MACG-18 (REAR)</u> COMMANDING OFFICER H&HS-18 (REAR) MACS-8 MASS-2</p>
<p>MGEN W. K. JONES BGEN L. E. FRIBOURG</p> <p>COL R. P. WRAY LTCOL W. S. DANIELS COL C. G. MOODY, JR. COL E. R. REID COL R. C. DAMM LTCOL M. J. GOTT LTCOL E. F. GRAYSON LTCOL A. D. BEACH</p> <p>COL W. E. BARRINEAU LTCOL W. A. HOLMBERG LTCOL D. J. GARRETT LTCOL J. P. KEHOE</p> <p>COL R. J. THOMAS LTCOL D. J. MCADAMS LTCOL J. R. VANDENELZEN LTCOL H. M. HART</p> <p>COL W. W. CROMPTON LTCOL F. W. STCLAIR LTCOL D. R. MCMILLAN, JR. LTCOL G. A. HIEBER</p> <p>COL G. G. CHAMBERS, JR. LTCOL J. R. VANDENELZEN LTCOL D. H. MITCHELL</p> <p>COL C. W. BOYD, JR. LTCOL D. J. MCADAMS MAJOR E. L. KUYKENDALL</p> <p>LTCOL C. F. KING, JR.</p> <p>LTCOL J. W. MEDIS LTCOL R. I. KRAMER MAJOR L. D. DERRYBERRY LTCOL K. L. CHRISTENSEN CAPT(MC) J. V. BROWN LTCOL R. W. MARTIN MAJOR A. E. HARWOOD MAJOR H. H. RUHL, JR. COL E. M. YOUNG LTCOL B. A. KASSMAN MAJOR A. W. LAMB</p>	<p>BGEN W. G. JOHNSON</p> <p>COL E. E. PEARCY MAJOR W. J. KLIMEK MAJOR F. G. NEWCOMB MAJOR J. W. PERSONS COL R. J. BARBOUR</p> <p>MAJOR M. S. VALENTINI</p> <p>MAJOR H. R. STENNIS</p> <p>COL E. E. PEARCY MAJOR L. K. WARN LTCOL R. MACARTHUR LTCOL D. W. ANDERSON LTCOL R. J. SORENSEN LTCOL D. L. HARVEY</p> <p>COL O. V. GALLENTEINE MAJOR J. F. GOLDEN MAJOR E. W. LOCKARD</p> <p>LTCOL A. H. MANHARD, JR. MAJOR E. L. KUYKENDALL LTCOL D. H. MITCHELL LTCOL T. F. LOTTSFELDT MAJOR J. A. BRANDON</p> <p>LTCOL P. E. SHEA MAJOR R. L. GOODLAKE LTCOL G. G. LONG MAJOR J. D. ODEN</p>

UNCLASSIFIED

Unclassified

UNCLASSIFIED

DISTRIBUTION OF MAJOR FMFPAC TACTICAL UNITS

17 FEBRUARY 1970

UNIT	CHU LAI	DANANG	NoICTZ/DMZ	OKINAWA	JAPAN	HAWAII	EASTPAC	OTHER	NOTE
1ST MARINES		1/1, 2/1, 3/1							
3D MARINES						1/3	2/3, 3/3		
4TH MARINES				1/4, 2/4, 3/4					
5TH MARINES		1/5, 2/5, 3/5							
7TH MARINES		1/7, 2/7, 3/7							
9TH MARINES				3/9				1/9, 2/9	1
26TH MARINES		1/26, 2/26, 3/26							
MAG-11		VMCJ-1 VMA(AW)-225 VMA(AW)-242 VMO-2							
MAG-12	VMA-211 VMA-311								
MAG-13	VMFA-115 VMFA-314 VMA-122								
MAG-16		HML-367 HML-167 HMH-463 HMM-263 HMM-364 HMM-161 HMM-262							
MAG-36				VMO-6 HMH-462				HMM-164 HMM-165	1 1
MAG-15					VMFA-232 VMFA-334 VMA(AW)-533				
MAG-24						VMFA-212 VMFA-235			
MAG-33							VMA-223 VMCJ-3 VMA-214 VMFA-323* VMFA-531 VMFA-542		2 2
MAG-56							HML-267 HMM-363 HMM-163 HMM-361 HMM-265		2

DISTRIBUTION OF MAJOR GROUND EQUIPMENT

EQUIPMENT	T/E AUTH	CHU LAI	DANANG	NoICTZ/DMZ	OKINAWA	HAWAII	EASTPAC	OTHER	NOTE
60mm MORTAR M19	254		144		60	12	24	12	1
81mm MORTAR M29	168		96		40	8	16	8	1
106mm RR M40A1C	168		96		40	8	16	8	1
107mm MORTAR M30	42		24		6	6		6	1
105mm HOW TD M101A1	136		72		30	6	12	6	1
155mm HOW SP M109	42		24		12		6		
175mm GUN (SP)	18		12	6					
81n HOW SP M110	14		12	2					
ONTOS M50A1	115		15		75		15	10	1
90mm TANK M48A3	126		73		36		17		
120mm TANK M103A2	17						17		
FLAME TANK M67A2	27		12		9		6		
LVTH6	18		6		12				
LVTP5	280		112		113		44	11	1
LVTE1	24		8		8		8		
HAWK LAUNCHERS	36						36		

NOTES: 1. UNITS/EQUIPMENT IN OTHER ASSIGNED TO SLP's.
2. ENROUTE CONUS.
3. ENROUTE OKINAWA.
* CATRE

Unclassified
UNCLASSIFIED

~~UNCLASSIFIED~~
~~CONFIDENTIAL~~

DISTRIBUTION OF AIRCRAFT, FMFPAC

17 FEBRUARY 1970

UNIT	DAWANG	CHG LAI	PBO BAI	ORIHAWA	JAPAN	HAWAII	EASTPAC	OTHER
HD SODN, FMFPAC						6/T-1A 1/C-54R 1/C-47J		
MAG-11 H&MS-11	8/TA-4F 1/C-117D							
VMCJ-1	9/RF-4B							
VMA(AW)-242	8/EA-6A							
VMA(AW)-225	12/A-6A							
VMO-2	11/A-6A							
	19/OV-10A							
MAG-12 H&MS-12		1/C-117D						
VMA-211		19/A-4E						
VMA-311		19/A-4E						
MAG-13 H&MS-13		1/C-117D						
VMFA-115		14/F-4B						
VMFA-314		15/F-4B						
VMFA-122		11/F-4B						
MAG-15 H&MS-15					1/C-540 1/C-117D 3/TA-4F 1/C-54S 14/F-4J			
VMFA-232					12/F-4J			
VMFA-334					11/A-6A			
VMA(AW)-533								
MAG-16 H&MS-16	2/C-117D 1/CH-46A							
HMT-167	25/VH-1E							
HMT-367	24/AH-1G							
HMM-263	21/CH-46D							
HMM-161	21/CH-46D							
HMM-262	21/CH-46D							
HMM-364	20/CH-46D							
HMH-463	21/CH-53A/D							
MCCRTG-10 H&MS-10								
VMAT-102							26/A-4C	
VMT-103							16/TA-4F	
MWSG-17 H&MS-17	3/US-2B 3/C-117D							
MHTG-30 H&MS-30							5/CH-46D	
HMHT-301							14/CH-53A	
HMHT-302							18/CH-46D	
MAG-33 H&MS-33							2/F-4B 6/TA-4F	
VMA-223							20/A-4E	**
VMCJ-3							8/RF-4B 1/F-4B 12/EF-10B 23/A-4C	**
VMA-214								
VMFA-323 (CAIRE)							12/F-4B	
VMFA-531							23/F-4B	
VMPAT-101							15/F-4B	**
VMFA-542								
MAG-36 H&MS-36				1/C-117D 1/CH-46A				
VMGR-152				12/KC-130F				
HMM-165								18/CH-46A
HMM-164								19/CH-46A
HMM-162				20/CH-53A				
HMH-462				11/VH-1E				
VMO-6				18/OV-10A				

NOTES: * ASSIGNED TO SLP's
** ENROUTE CONUS

~~UNCLASSIFIED~~
~~CONFIDENTIAL~~

Unclassified

~~UNCLASSIFIED~~
UNCLASSIFIED

MARINE CORPS COMMAND CENTER

DISTRIBUTION OF AIRCRAFT, FMFPAC

17 FEBRUARY 1970

UNIT	DANANG	CUO LAI	PHU BAI	OKINAWA	JAPAN	HAWAII	EASTPAC	OTHER
MMSG-37 H&MS-37							2/C-47J 1/C-54R 2/C-117D 1/C-47H	
VMGR-352							11/KC-130F	
MAG-56 H&MS-56							4/CH-46D 11/CH-53A 1/UH-1E	
HMM-163							25/CH-46F	
HML-267							7/OV-10A 16/UH-1E 14/CH-53A	**
HMH-361							19/CH-53A	
HMH-363							7/CH-46D	
HMM-265							1/CH-53A	
MABS-56								
1ST MARINE BRIGADE MAG-24 H&MS-24						1/C-117D 6/UH-34D 3/TA-4F		
VMFA-212						15/F-4J		
VMFA-235						14/F-4J		
TOTAL FMFPAC ACFT								
FIXED WING (460)	76	80		31	43	41	189	
HELICOPTERS (364)	155			32		6	134	37

NOTE: * ASSIGNED TO SLF's
** ENROUTE CONUS

~~CONFIDENTIAL~~
UNCLASSIFIED
Unclassified

MARINE CORPS COMMAND CENTER

5TH MARINE EXPEDITIONARY BRIGADE

READINESS SUMMARY

17 FEBRUARY 1970

UNIT	*REPORT DATE	STRENGTH		COMBAT READINESS							
				CURRENT					EXPECTED		
				RATING	REASON	P	S	E	T	RATING	DATE
5TH MEB				C2	T	1	1	1	2	C1	700430
H&SCO (-) (REIN)		1393	27	C1		1	1	1	1		
3D MARINES (-)				C2	P	2	1	1	2	C1	700228
HQS CO (-)		289	9	C1		1	1	1	1		
2nd BN		1081	56	C3	T	3	1	1	3	C1	700801
3rd BN		1086	55	C2	P	2	1	1	2	C3	700215
1ST BN, 12TH MARINES (-)		1095	21	C1	X	1	1	1	1		
"A" CO, 3D AT BN (-)		94	7	C2	T	1	1	1	2	C1	700301
"A" CO, 3D RECON BN (-)		92	5	C3	R	1	1	3	1	C2	700331
"C" CO, 3D MED BN (-)		78	53	C2	P	2	1	1	2	C1	700228
"B" CO, 3D ENGR BN (-)		155	1	C1		1	1	1	1		
"B" CO, 3D MT BN (-)		76	1	C2	T	1	1	1	2	C1	700730
"B" CO, 3D SP BN (-)		133	16	C1		1	1	1	1		
"D" CO, 3D TANK BN (REIN)		197	7	C2	T	1	1	1	2	C1	700301
DET, 3D SERVICE BN		911	18	C1		1	1	1	1		
REINFORCING UNITS											
COMM SPT CO, 9TH COMM BN		268		C1		1	1	1	1		
"B" CO, 11TH ENGR (REIN)		252	2	C1		1	1	1	1		
"B" CO, 9TH MT BN (REIN)		159	1	C1		1	1	1	1		
"A" CO, 1ST AMTRAC BN (-)		218	4	C1		1	1	1	1		
13TH ITT		15		C4		4	1	1	4	C3	700228
9TH SSCT		6		C1		1	1	1	1		
13TH CIT		29		C1		1	1	1	1		
1ST SEARCHLIGHT BTRY				C4	N	4	4	4	4	C4	700601
9TH SEP BULK FUEL CO		356		C2	T	1	1	1	2	C1	700215
DET, 5TH DENTAL CO		16		C1		1	1	1	1		
3D BRIDGE CO (-)		141	1	C2	T	1	1	1	2	C1	700228
3D HOSPITAL CO		36	63	C2	P	2	1	1	2	C1	700601
1ST AMRD AMPHIB CO (-)		88		C4	S	1	4	4	4	C3	700601
1ST CIVIL AFFAIRS GROUP		74	4	C3	T	3	1	1	3	C2	700302
21ST ITT		8		C4	P	4	1	1	4	C3	700131

READINESS CATEGORIES

- C-1 Fully Combat Ready
- C-2 Substantially Combat Ready
- C-3 Marginally Combat Ready
- C-4 Not Combat Ready

READINESS ABBREVIATIONS

- P Personnel Readiness
- S Supplies/Equipment on Hand
- E Equipment Readiness
- T Training Readiness
- X Commanders Subjective Judgement-Elaborated by remarks
- N Resource allocation by cognizant service does not permit a higher C-rating

NOTE: Readiness Category Information extracted from SMU REPORT DATES 16FEB70.
Strength Category Information extracted from MCCC Report dated 12FEB70.

Unclassified
UNCLASSIFIED

UNCLASSIFIED

WESTPAC UNIT LOCATIONS

17 FEBRUARY 1970

QUANG TRI

(QUANG TRI)

USMC 738
USN 37
USA 5,826

- 1ST BDE, 5TH INF DIV (MECH)
- 1/77 ARMOR (OPN GREENE RIVER)
- 1/61 INF (MECH) (OPN GREENE RIVER)
- 1/11 INF (OPN GREENE RIVER)
- 3/5 ARMD CAV SQDN (OPN GREENE RIVER)

THUA THIEN

HO, XXIV CORPS (PHU BAI)

HO, 101st ABN DIV (AM)

- 1ST BDE, 101ST ABN DIV (AM)
 - 1/327 INF (AM) (OPN RANDOLPH GLEN)
 - 2/327 INF (AM) (OPN RANDOLPH GLEN)
 - 2/502 INF (AM) (OPN RANDOLPH GLEN)
- 2D BDE, 101ST ABN DIV (AM)
 - 1/501 INF (AM) (OPN RANDOLPH GLEN)
 - 2/501 INF (AM) (OPN RANDOLPH GLEN)
 - 1/502 INF (AM) (OPN RANDOLPH GLEN)
- 3D BDE, 101ST ABN DIV (AM)
 - 1/506 INF (AM) (OPN RANDOLPH GLEN)
 - 2/506 INF (AM) (OPN RANDOLPH GLEN)
 - 3/187 INF (AM) (OPN RANDOLPH GLEN)

USMC 941
USN 46
USA 26,259

QUANG NAM

HOS 1ST MAR DIV (DANANG)

1ST MARINES

- 1/1
- 2/1
- 3/1

5TH MARINES

- 1/5
- 2/5
- 3/5

7TH MARINES

- 1/7
- 2/7
- 3/7

26TH MARINES

- 1/26
- 2/26
- 3/26

HOS, III MAF

USMC 45,373
USN 1,841
USA 1,110

HO 1st MAW
MAG-11

- VMA(AW)-242 (A-6A)
- VMA(AW)-225 (A-6A)
- VMCJ-1 (RF-4/EA-6/EF-10)
- VMO-2 (OV-10A)

MAG-16

- HML-367 (AH-1G)
- HML-167 (UH-1E)
- HMH-463 (CH-53A)
- HMM-364 (CH-46D)
- HMM-263 (CH-46D)
- HMM-262 (CH-46D)
- HMM-161 (CH-46D)

2d ROKMC BDE

- 1/2 (OPN VICTORY DRAGON XIX)
- 2/2 (OPN VICTORY DRAGON XIX)
- 3/2 (OPN VICTORY DRAGON XIX)
- 5/2 (OPN VICTORY DRAGON XIX)

FLC 1ST FSR/FLSG-B/1ST SERV BN

QUANG TIN/QUANG NGAI

HO 23d INF DIV (AMERICAL) (CHU LAI)

196TH LT INF BDE

- 2/1 INF (OPN FREDERICK HILL)
- 4/31 INF (OPN FREDERICK HILL)
- 3/21 INF (OPN FREDERICK HILL)
- 1/46 INF

198TH LT INF BDE

- 1/6 INF (OPN GENEVA PARK)
- 1/52 INF (OPN GENEVA PARK)
- 5/46 INF (OPN NANTUCKET BEACH)

11TH INF BDE

- 1/20 INF (OPN IRON MOUNTAIN)
- 4/21 INF (OPN IRON MOUNTAIN)
- 3/1 INF (OPN IRON MOUNTAIN)
- 4/3 INF (OPN IRON MOUNTAIN)
- 1/1 ARMD CAV SQDN (OPN IRON MOUNTAIN)

1st MAW

- MAG-12 (A-4E)
- VMA-211 (A-4E)
- VMA-311 (A-4E)

MAG-13

- VMFA-115 (F-4B)
- VMFA-314 (F-4B)
- VMFA-122 (F-4B)

USMC 5,215
USN 116
USA 24,391

OKINAWA

HO, I MEF
3D MARDIV (-) (REIN)(TF-79)
11th MEB (TF-79.1)

OSD PROGRAM VIII CEILING

USMC 19,200
USN 934

ACTUALS CHARGED AGAINST
PROGRAM VIII AS OF 5FEB70.

18,580
424

4TH MARINES

- 1/4
- 2/4
- 3/4

9TH MARINES

- 3/9

MAG-36

- VMGR-152 (KC-130F)
- VMO-6 (OV-10A/UH-1E)
- HMH-462 (CH-53A)

14,061 (349)

3D FSR (3,456)
MCB CAMP BUTLER/NON FMF (915)
Non-Deployable Casuals (148)
SVN-Originated Patients (0)

(50)
(25)

USMC RVN RECAP

USMC USN

OSD PROGRAM VIII CEILING 55,510 2,233

ACTUALS CHARGED AGAINST PROGRAM VIII AS OF 13FEB70 52,575 2,040

III MAF 52,267 2,040

SU#1 1ST ANGLICO (212) (14)

OTHER 308

MACV STAFF/MACV FIELD (272)

NAVAIDGRU/NAVY UNITS (36)

I CORPS RECAP

US MARINE CORPS (12 BNs) 52,267

US ARMY (25 BNs) 73,849

US NAVY 16,954

US AIR FORCE 8,194

ROKMC (4 BNs) 6,148

RVNAF (36 BNs) 153,895

ARVN/ABN (36 BNs) (74,634)

VNMC

VNN (2,100)

VNAF (3,408)

VNRF (37,403)

VNPF (36,350)

I CORPS TOTAL 77 BNs 311,307

SLF 7TH FLEET

USMC USN

BRAVO: BLT 2/9 1,847 60
HMM-165

● ENR SUBIC BAY
ETA: 22FEB70

ALFA: BLT 1/9 1,868 85
HMM-164
AT OKINAWA

MOVEMENTS

Det 12th Mar and "D" Co, 3d Recon Bn.
At Fuji for training.

JAPAN

USMC USN

OSD PROGRAM VIII CEILING 3,600 45

ACTUALS CHARGED AGAINST PROGRAM VIII AS OF 5FEB70. 3,749 34

1ST MAW (REAR)

MAG-15 (2,553) (34)

VMFA-232 (F-4J)

VMFA-334 (F-4J)

VMA(AW)-533 (A-6A)

*Does NOT include 243 hospitalized
SVN-Originated Patients.

Non FMF (1,196)

* Includes only U. S. Navy Personnel organic to FMF Units.
Includes SU#1 and 1st ANGLICO at various locations throughout SVN.
• Latest Change

Unclassified

UNCLASSIFIED

MARINE CORPS
FEB 17 1970
REFERENCE BRANCH

Unclassified

SUMMARY OF MAJOR US AND FWMAF OPERATIONS

OPERATION (DATE COMMENCED)	UNITS INVOLVED	LOCATION	CASUALTIES AS OF: 172400H FEB70		
			FRIENDLY		ENEMY
			KIA	WIA	KIA.
GREENE RIVER (19JAN70)	1ST BDE, 5TH INF DIV (MECH); 4 USA BNS	EASTERN QUANG TRI PROVINCE	4	112	61
RANDOLPH GLEN (7DEC69)	101ST ABN DIV (AM); 9 USA BNS	QUANG TRI & THUA THIEN PROVINCES	58	260	412
VICTORY DRAGON XIX (1JAN70)	2D ROKMC BDE; 4 ROKMC BNS	HOI AN AREA	1	12	13
FREDERICK HILL (18MAR69)	196TH INF BDE: 3 USA BNS	QUANG TIN PROVINCE	370	2,343	4,498
GENEVA PARK (18JUL69)	198TH INF BDE: 2 USA BNS	QUANG TIN & QUANG NGAI PROVINCES	126	858	1,155
NANTUCKET BEACH (20JUL69)	198TH INF BDE: 1 USA BN	CENTERED 15 KM NE OF QUANG NGAI CITY	24	220	250
IRON MOUNTAIN (18MAR69)	11TH INF BDE: 5 USA BNS	QUANG NGAI PROVINCE	288	1,672	2,500

• - ADJUSTED
- FINAL CUMULATIVE CASUALTIES

UNCLASSIFIED

Unclassified

~~UNCLASSIFIED~~
UNCLASSIFIED

MARINE CORPS COMMAND CENTER

USMC/ENEMY CASUALTIES IN RVN

17 FEBRUARY 1970

USMC BATTLE CASUALTIES

KIA/DOW	WIA(EVAC)	WIA(RTD)	MIA/PW
12,470	48,879	35,835	80/21

USMC CASUALTY FIGURES ARE PROVIDED DAILY BY HQMC CASUALTY SECTION (CODE DNA) AND REFLECT ALL CASUALTIES REPORTED AS OF 16FEB70.

USMC NON-BATTLE CASUALTIES

DEAD	INJURED	MISSING
1,506	1,822	12

FIGURES INDICATED AS INJURED ARE ONLY THOSE IN SERIOUS/CRITICAL INJURY OR DISEASE CATEGORY AND DO NOT INCLUDE THOSE OF A MINOR NATURE

USMC INFLECTED ENEMY CASUALTIES

KIA	PW	WPNS
80,590	4,199	20,810

ENEMY CASUALTIES ARE COMPILED DAILY FROM THE III MAF HISSUM AND ARE RECONCILED MONTHLY WITH THE FMFPAC SUMMARY OF USMC OPERATIONS IN RVN

TYPICAL DISPOSITION OF 100 USMC WIA *

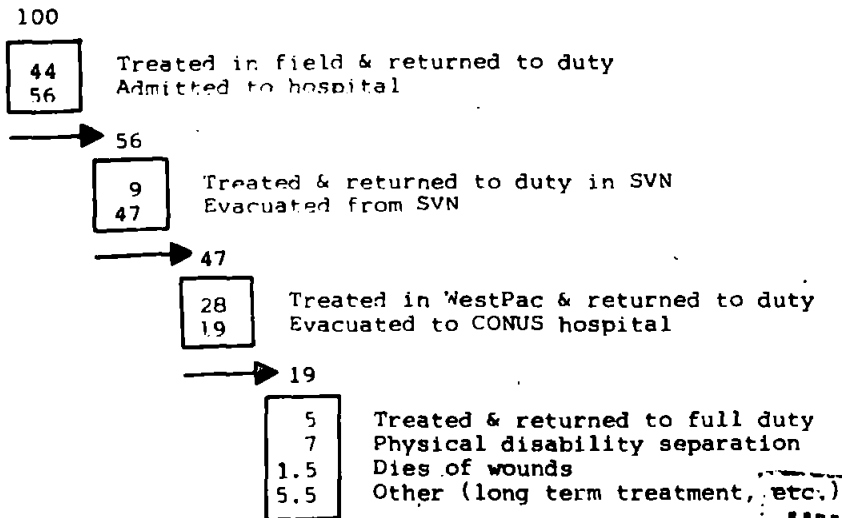

*54,081 CASUALTIES, JAN67-DEC68.

~~UNCLASSIFIED~~
UNCLASSIFIED

Unclassified

UNCLASSIFIED
CONFIDENTIAL

MARINE CORPS COMMAND CENTER

SPECIAL LANDING FORCE, 7TH FLEET

SLF BRAVO

17 FEBRUARY 1970

TASK GROUP 79.4 CTG: COL G. G. CHAMBERS JR.	STRENGTH				ARMS & EQUIPMENT	LOCATION														
	USMC		USN																	
UNITS EMBARKED	OFF	ENL	OFF	ENL																
SLF HQS DET					B M29 81MM MORTARS 3 M40 106MM RR 6 M30 107MM MORTARS 4 M101A1 105MM HOW 4 M48 90MM TANKS 5 LVTP-5 AIRCRAFT 18/CH-46A	ENROUTE SUBIC ETA: 22FEB70														
BLT 2/9 (LTCOL J. R. VANDENELZEN)	52	1500	1	56			SHIPPING USS NEW ORLEANS (LPH-11) USS THOMASTON (LSD-28) USS VANCOUVER (LPD-2) USS WHITFIELD CTY (LST-1169)													
2D BN, 9TH MARINES						SUPPLIES CLASS I CLASS II CLASS III CLASS IV CLASS V														
W/2/12																				
F/2/12																				
PLAT, CO "B", 1ST AMTRAC																				
PLAT, CO "C", 3D ENGR BN																				
PLAT, CO "C", 3D SP BN																				
PLAT, CO "C", 3D MT BN																				
PLAT, CO "C", 3D RECON BN																				
PLAT, CO "A", 3D TK BN																				
CLEAR PLAT, CO "B", 3D MED																				
SQD, MP CO, 3D MARDIV																				
DET, HQBN, 3D MARDIV																				
DET, COMM PLT, HQCO, 9TH MAR																				
DET, COMM SPT CO, 7TH COMM																				
DET, 3D DENTAL CO																				
LSU																				
HMM-165 (LTCOL P. H. MITCHELL)	69	226	1	2																
TOTALS	121	1726	2	58																

SLF ALFA

28 JANUARY 1970

TASK GROUP 79.5 CTG: COL C. W. BOYD, JR.	STRENGTH				ARMS & EQUIPMENT	LOCATION														
	USMC		USN																	
UNITS EMBARKED	OFF	ENL	OFF	ENL																
SLF HQS DET					12 M10 60MM MORTARS 8 M29 81MM MORTARS 8 M40 106 MM RR 6 M30 107 MM MORTARS 6 M101A1 105 MM HOW 5 M48 90MM TANKS AIRCRAFT 19 /CH-46A's	AT OKINAWA														
BLT 1/9 (LTCOL D. J. MC ADAMS)	54	1596	6	76			SHIPPING													
1ST BN, 9TH MARINES						SUPPLIES CLASS I 30 DAYS CLASS II 30 DAYS CLASS III 30 DAYS CLASS IV 30 DAYS CLASS V 30 DAYS														
MORT BTRY, 2/12																				
BTRY "D" (REIN), 2/12																				
PLAT, CO "B", 1ST AMTRACBN																				
PLAT, CO "C", 3D ENGR BN																				
PLAT, CO "C", 3D SP BN																				
PLAT, CO "A", 3D MT BN																				
PLAT, CO "C", 3D RECON BN																				
PLAT, CO "C", 3D TK BN																				
CLEAR PLT, CO "B", 3D MED BN																				
SQD, MP CO, 3D MARDIV																				
DET, HQ BN																				
DET, COMM PLT HQ CO, 9THMAR																				
DET, 3D DENTAL CO																				
LSU																				
DET BMU NBB																				
HMM-164 (LTCOL R. D. FOWNER)	41	177	1	2																
TOTALS	95	1773	7	78																

CONFIDENTIAL
UNCLASSIFIED

UNCLASSIFIED

SUMMARY OF MARINE CORPS AMPHIBIOUS OPERATIONS IN SOUTH VIETNAM

17 FEBRUARY 1970

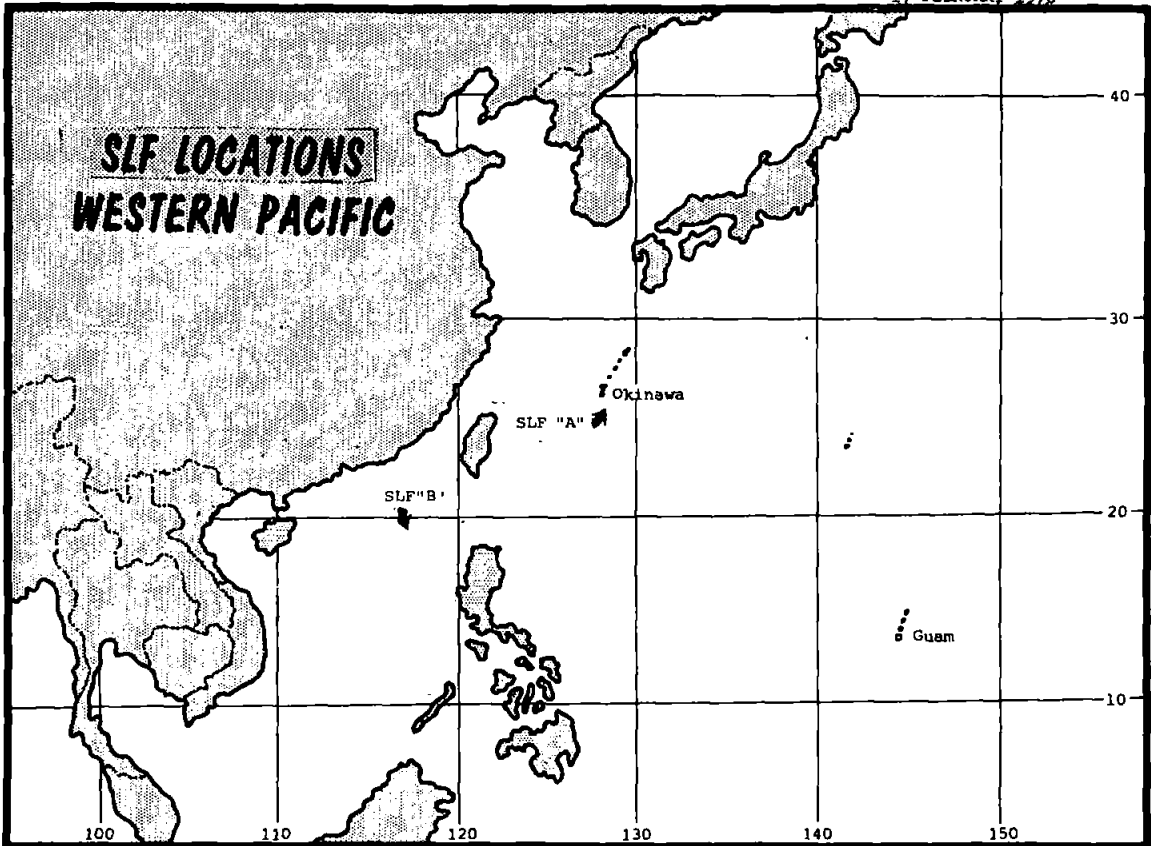

TOTAL AMPHIBIOUS OPERATIONS 71

(INCLUDING SLF OPERATIONS AS INDICATED ON THIS AND SUBSEQUENT PAGES)

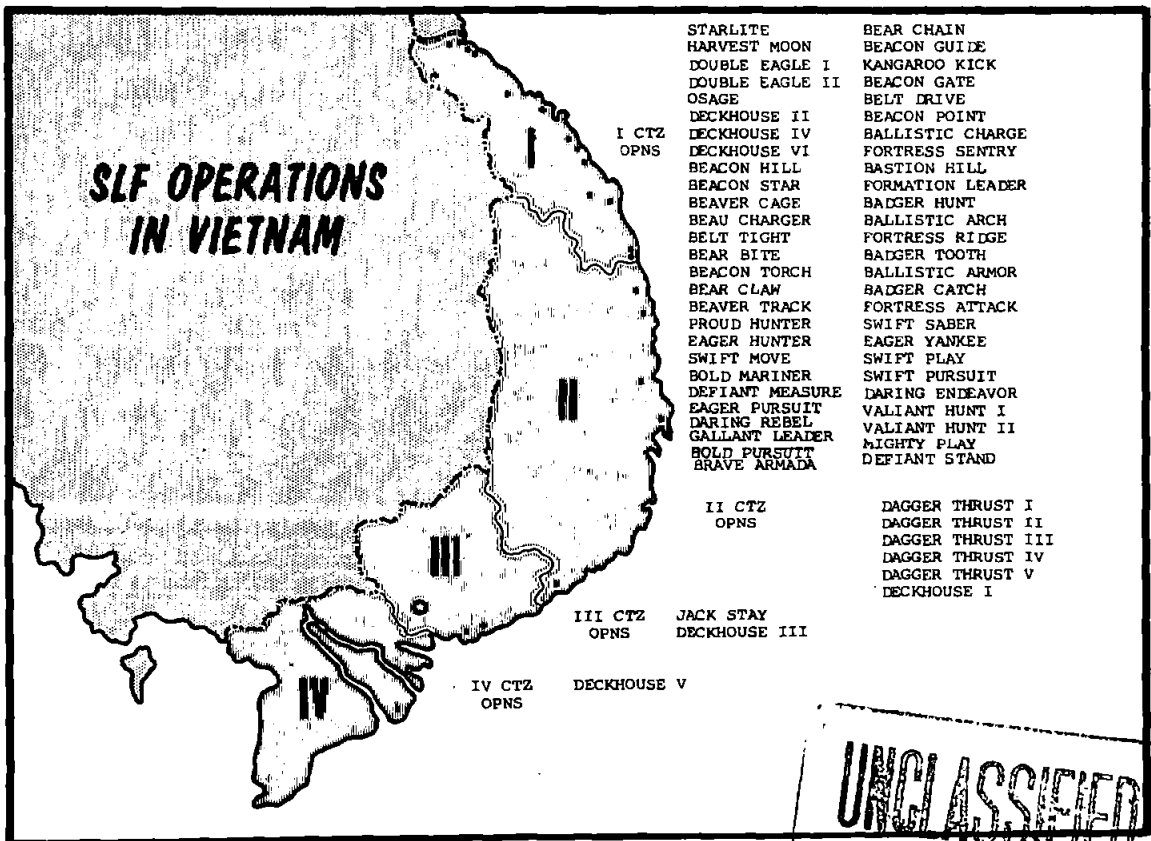

UNCLASSIFIED

SUMMARY OF SLF OPERATIONS ON FOLLOWING PAGE

UNCLASSIFIED

CINCPAC
VIETNAM & THAILAND - AIR FORCE

17 FEBRUARY 1970

VIETNAM AIR FORCE

THAILAND AIR FORCE

BAN ME THOUT

UH-1 7

BIEN HOA

F-100 21

A-37 65

O-1 58

O-2 83

OV-10 44

UC-123 13

C-7 1

C-47 2

HH-43 2

CAM RANH BAY

F-4 35

C-7 27

C-130 44

HH-43 2

O-1 23

O-2 63

RC-130 5

DA NANG

F-4 48

O-2 82

OV-10 38

HH-3 13

HH-43 2

C-47 1

A-1 10

AC-119 7

NHA TRANG

C-123 4

C-130 3

PHAN RANG

F-100 74

C-123 42

HH-43 2

AC-119 14

PHU CAT

EC-47 6

C-7 26

F-4 35

HH-43 1

AC-119 5

PLEIKU

EC-47 14

HH-43 2

TAN SON NHUT

RF-4 33

C-123 17

RB-57 4

RF-101 16

C-130 15

HH-43 2

EC-47 18

AC-119 5

TUY HOA

F-100 84

HC-130 11

HH-43 2

C-47 3

O-2 14

AC-119 4

UH-1 4

VUNG TAU

C-7 31

BANGKOK

F-102 4

C-130 5

KORAT

F-4 35

HH-43 2

EC-121 26

C-121 1

NAKHOM PHANOM

UC-123 5

C-123 6

A-1 61

O-2 12

OV-10 20

HH-3 4

CH-3 6

EC-47 5

TAKHLI

F-105 67

EB-66 16

HH-43 2

UBON

F-4 77

C-130 7

HH-43 3

AC-130 7

OV-10 10

AC-123 2

UDORN

RF-4 36

AC-47 3

F-4 35

HH-43 1

HH-53 8

C-130 6

CH-3 4

U-TAPAO

HH-43 2

27-1

UNCLASSIFIED

Unclassified

UNCLASSIFIED

MARINE CORPS COMMAND CENTER

FLEET MARINE FORCE ATLANTIC

READINESS SUMMARY

17 FEBRUARY 1970

UNIT	REPORT DATE	STRENGTH		COMBAT READINESS							
		USMC	USN	RATING	REASON	P	S	E	T	EXPECTED RATING	DATE
2D MARINE DIVISION				C2	T	1	1	1	2	C1	700401
HEADQUARTERS BN		2107	52	C2	T	1	1	1	2	C1	700331
2D MARINES		3828	99	C3	T	2	1	1	3	C2	700228
1st Bn		1216	21	C3	P	3	1	1	3	C2	700302
2nd Bn		997	19	C4	P	4	1	1	3	C3	700228
3rd Bn		1309	50	C2	P	2	1	1	1	C3	700705
6TH MARINES		3784	109	C2	T	1	1	1	2	C1	700215
1st Bn		1174	37	C1		1	1	1	1	C2	700301
2nd Bn		1183	36	C1		1	1	1	1		
3rd Bn		1054	25	C2	T	1	1	1	2	C1	700215
8TH MARINES		4256	109	C2	T	1	1	1	2	C1	700301
1st Bn		1334	35	C2	T	1	1	1	2	C1	700228
2nd Bn		1374	34	C1		1	1	1	1	C2	700630
3rd Bn		1189	36	C2	P	2	1	1	1	C3	700301
10TH MARINES		3185	50	C1		1	1	1	1	C2	700430
1st Bn		825	11	C1		1	1	1	1	C2	700430
2nd Bn		756	11	C1		1	1	1	1	C2	700430
3rd Bn		690	5	C1		1	1	1	1	C2	700430
4th Bn		641	7	C2		1	1	2	1	C1	700302
2D SERVICE BN		1269	26	C2	T	1	1	1	2	C1	700302
2D AT BN		463	7	C2	S	1	2	2	2	C1	700331
2D MT BN		306	6	C1		1	1	1	1	C2	700201
2D RECON BN		493	12	C2	T	1	1	1	2	C1	700301
2D ENGR BN		906	8	C2	T	1	1	1	2	C1	700301
2D SP BN		570	16	C2	R	1	1	2	1	C1	700331
2D MEDICAL BN		151	114	C4	N	4	1	1	4		
2D DENTAL CO			65	C1		1	1	1	1	C2	700630
FORCE TROOPS FMFLANT											
2D FSR		3110	29	C3	P	3	2	2	3	C2	700401
2D FAG		563	4	C3	R	1	2	3	2	C1	700401
2D 155 GUN BTRY		177		C3	T	2	2	2	3	C1	700401
2D 81N HOW BTRY		226		C3	R	1	1	3	1	C1	700401
2D TANK BN		794	8	C2	R	1	2	2	1	C1	700601
2D AMTRAC BN		1095	11	C3	R	1	2	3	1	C2	700331
2D FORCE RECON CO		135	2	C3	T	2	1	1	3	C2	700401
2D RADIO BN		419	2	C2	S	2	2	2	2	C1	700731
2D ANGLICO		291	11	C4	P	4	3	3	2	C3	700331
2D BRIDGE CO		158	1	C2	P	2	1	1	1	C1	700601
2D TOPO CO		90	1	C4	P	4	1	1	2	C3	700430
2D HOSPITAL CO		32	17	C4	P	4	1	1	4	C3	700228
4TH DENTAL CO		5	33	C4	P	4	1	1	1	C3	700430
8TH COMM BN		740	7	C3	S	2	3	2	2	C2	700301
8TH MT BN		473	3	C1		1	1	1	1		
8TH ENGR BN		1216	11	C2	R	1	2	2	2	C1	700331
2D MARINE AIRCRAFT WING				C3	R	3	2	3	3	C2	700531
3D LAAM BN		631	7	C3	R	3	3	3	3	C2	700303
MWSG-27				C3	P	3	1	1	3	C2	700519
VMGR-252		285	2	C3	X	4	1	3	2	C3	700601
MAG-14				C3	X	4	1	4	4	C3	700410
VMA(AW)-224		222	2	C3	X	4	1	3	4	C3	700319
VMA(AW)-121		201	1	C4	P	4	1	4	4	C3	700515
VMA(AW)-332		216	2	C3	X	3	1	4	4	C2	700416
VMCJ-2		370	2	C3	X	3	1	4	2	C2	700430
VMA-322		216	2	C3	X	3	1	3	4	C2	700416
VMFA-513		216	2	C4	P	4	1	4	4	C3	700330
MAG-26				C4	R	3	2	4	2	C3	700401
VMO-1		277		C3	P	3	2	3	2	C2	700226
HMM-362		109		C4	P	4	1	4	4	C3	700331
HMM-162		203	1	C3	R	2	2	3	1	C2	700315
HMM-261		234	3	C4	P	4	1	2	2	C3	700503
HMM-264		204		C4	P	4	1	3	1	C3	700401
HMM-365		195	1	C4	R	2	1	4	2	C3	700331
HMH-461		164	1	C4	P	4	1	4	4	C3	700510
MAG-31				C3	T	3	2	3	3	C2	700531
VMF-333		215	1	C3	T	3	1	3	3	C2	700531
VMA-331		163	1	C3	T	2	1	3	3	C2	700601
VMF(AW)-451		215	1	C3	T	3	1	3	3	C2	700601
MAG-32				C3	P	3	2	3	3	C2	700630
VMFA-251		233	1	C4	P	4	2	4	4	C3	700602
VMFA-312		236	1	C4	T	3	2	3	4	C3	700601
VMFA-324		165	1	C3	X	4	2	3	3	C2	700501

READINESS CATEGORIES

- C-1 Fully Combat Ready
- C-2 Substantially Combat Ready
- C-3 Marginally Combat Ready
- C-4 Not Combat Ready

READINESS ABBREVIATIONS

- P Personnel Readiness
- S Supplies/Equipment on Hand
- E Equipment Readiness
- T Training Readiness

NOTE: READINESS CATEGORY INFORMATION EXTRACTED FROM STATUS OF MARINE UNIT REPORT DATED 16FEB70.
STRENGTH CATEGORY INFORMATION EXTRACTED FROM MCCC REPORT DATED 4FEB70.

Unclassified
UNCLASSIFIED

~~CONFIDENTIAL~~

MARINE CORPS COMMAND CENTER

UNCLASSIFIED
UNSELECTED

PERSONNEL AND AIRCRAFT DATA

PERSONNEL

18 FEBRUARY 1970

	STRENGTH	PERCENT USMC	PERCENT FMF	PERCENT FMPAC
USMC TOTAL	300,982 *	100.00		
FLEET MARINE FORCES	153,729	51.08	100.00	
FMF ATLANTIC	45,696 \$	15.18	29.73	
FMF PACIFIC	107,599 #	35.90	70.27	
VIETNAM	52,530 †	17.60	34.46	49.04

SOURCE: * MONTHLY USMC PERSONNEL ALLOCATION REPORT OF 30NOV69.
 \$ MCCC UNIT REPORT OF 4FEB70.
 # MCCC UNIT REPORT OF 21JAN70.
 † MACV WEEKLY STRENGTH REPORT AS OF 2400, 12FEB70 AS ADJUSTED BY THE MACV DAILY RPT OF ARR/DEP AS OF 2400, 16FEB70.

AIRCRAFT

5 FEBRUARY 1970

	FIXW	HELO	TOTAL	PERCENT USMC	PERCENT FMF	PERCENT FMPAC
USMC TOTALS	1013	569	1582	100.00		
FLEET MARINE FORCES	763	543	1306	82.55	100.00	
FMF ATLANTIC	303	156	459	29.01	35.15	
FMF PACIFIC	460	387	847	53.54	64.85	
VIETNAM	156	178	334	21.11	25.57	39.43

SOURCE: MARINE CORPS COMMAND CENTER UNIT REPORT OF 31DEC69.

UNCLASSIFIED
UNSELECTED
Unclassified

~~CONFIDENTIAL~~

UNCLASSIFIED FLEET MARINE FORCE DEPLOYMENTS

18 FEBRUARY 1970

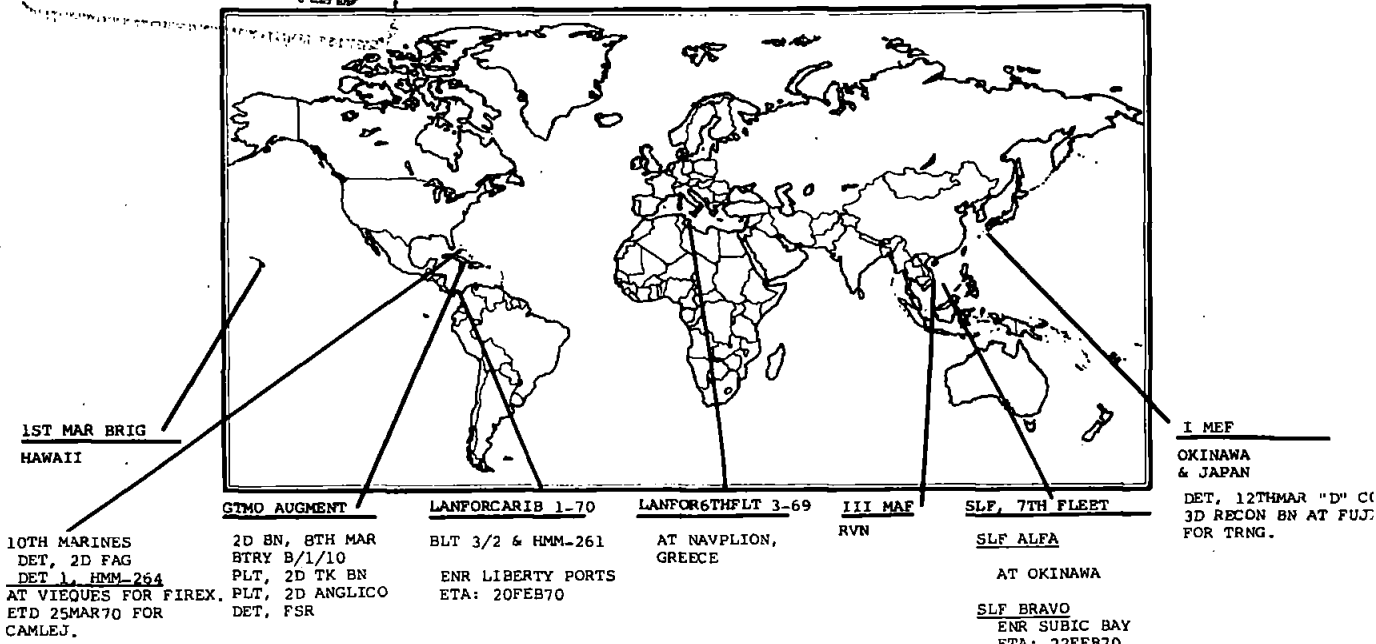

DISTRIBUTION OF MAJOR FMF UNITS

	INF BNS	VMFA	VMA	VMA(AW)	VMCI	BMN	BMB	HML	VMG	VMGR
WESTPAC	18	5	2	3	1	6	2	2	2	1
RVN	(12)	(3)	(1)	(2)	(1)	(4)	(1)	(2)	(2)	
OKINAWA/JAPAN	(4)	(2)	(1)*	(1)			(1)		(1)	(1)
ASSIGNED TO SLF'S	(2)					(2)				
MIDPAC	1	2								
HAWAII AFLOAT	(1)	(2)								
EASTPAC	2	**3	2		1	2	2	1		1
WEST COAST AFLOAT	(2)	(3)	(2)		(1)	(2)	(2)	(1)		(1)
ATLANTIC	8	5	2	3	1	4	2		1	1
EAST COAST CARIBBEAN	(6) (2)	(5)	(2)	(3)	(1)	(3) (1)	(2)		(1)	(1)
EUROPE	1									
MEDITERRANEAN	(1)									
GRAND TOTAL	30	15	6	6	3	12	6	3	3	3

* ENROUTE IWAKUNI.
** VMFA-323 IN CADRE STATUS.

UNCLASSIFIED

~~SECRET~~

UNCLASSIFIED

MARINE CORPS COMMAND CENTER

MARINE CORPS PERSONNEL IN RVN

18 FEBRUARY 1970

	OFF	ENL	TOTAL
* III MAF.	3,485	48,737	52,222
DANANG	(2,986)	(42,342)	(45,328)
CHU LAI	(391)	(4,824)	(5,215)
PHU BAI	(73)	(868)	(941)
DONG HA	(35)	(703)	(738)
SU #1, 1ST ANGLICO (AT VARIOUS LOCATIONS SVN)	((21))	((191))	((212))
OTHER USMC PERSONNEL	159	149	308
MACV STAFF/MACV FIELD	(136)	(136)	(272)
NAVAVGRU/NAVY UNITS	(23)	(13)	(36)
USMC IN RVN CHARGED AGAINST PROGRAM VIII	3,644	48,886	52,530
U. S. NAVY, III MAF.	256	1,784	2,040

* AS REPORTED BY III MAF DAILY ADMIN SITREP # 42 AS OF 2400, 10FEB70 AND THE MACV WEEKLY STRENGTH REPORT, AS OF 2400, 12FEB70 AS ADJUSTED BY MACV DAILY RPT OF ARR/DEP AS OF 2400, 16FEB70

Unclassified

UNCLASSIFIED
~~SECRET~~

WESTPAC UNIT LOCATIONS

18 FEBRUARY 1970

UNCLASSIFIED
QUANG TRI

(QUANG TRI)
1ST BDE, 5TH INF DIV (MECH)
1/77 ARMOR (OPN GREENE RIVER)
1/61 INF (MECH) (OPN GREENE RIVER)
1/11 INF (OPN GREENE RIVER)
3/5 ARMD CAV SQDN (OPN GREENE RIVER)

USMC 738
USN 37
USA 5,826

THUA THIEN

HQ, XXIV CORPS (PHU BAI)
HQ, 101st ABN DIV (AM)

1ST BDE, 101ST ABN DIV (AM)
1/327 INF (AM) (OPN RANDOLPH GLEN)
2/327 INF (AM) (OPN RANDOLPH GLEN)
2/502 INF (AM) (OPN RANDOLPH GLEN)
2D BDE, 101ST ABN DIV (AM)
1/501 INF (AM) (OPN RANDOLPH GLEN)
2/501 INF (AM) (OPN RANDOLPH GLEN)
1/502 INF (AM) (OPN RANDOLPH GLEN)
3D BDE, 101ST ABN DIV (AM)
1/506 INF (AM) (OPN RANDOLPH GLEN)
2/506 INF (AM) (OPN RANDOLPH GLEN)
3/187 INF (AM) (OPN RANDOLPH GLEN)

USMC 941
USN 46
USA 26,259

QUANG NAM

HOS 1ST MAR DIV (DANANG)

1ST MARINES
1/1
2/1
3/1

5TH MARINES
1/5
2/5
3/5

7TH MARINES
1/7
2/7
3/7

26TH MARINES
1/26
2/26
3/26

HOS, III MAF

HQ 1st MAW
MAG-11

VMA(AW)-242 (A-6A)
VMA(AW)-225 (A-6A)
VMCJ-1 (RF-4/EA-6/EF-10)
VMO-2 (OV-10A)

MAG-16
HML-367 (AH-1G)
HML-167 (UH-1E)
HMH-463 (CH-53A)
HMM-364 (CH-46D)
HMM-263 (CH-46D)
HMM-262 (CH-46D)
HMM-161 (CH-46D)

2d ROKMC BDE

1/2 (OPN VICTORY DRAGON XIX)
2/2 (OPN VICTORY DRAGON XIX)
3/2 (OPN VICTORY DRAGON XIX)
5/2 (OPN VICTORY DRAGON XIX)

USMC 45,328
USN 1,841
USA 1,110
ROKMC 7,145

FLC 1ST FSR/FLSG-B/1ST SERV BN

QUANG TIN/QUANG NGAI

HQ 23d INF DIV (AMERICAL) (CHU LAI)

196TH LT INF BDE
2/1 INF (OPN FREDERICK HILL)
4/31 INF (OPN FREDERICK HILL)
3/21 INF (OPN FREDERICK HILL)
1/46 INF

198TH LT INF BDE
1/6 INF (OPN GENEVA PARK)
1/52 INF (OPN GENEVA PARK)
5/46 INF (OPN NANTUCKET BEACH)

11TH INF BDE
1/20 INF (OPN IRON MOUNTAIN)
4/21 INF (OPN IRON MOUNTAIN)
3/1 INF (OPN IRON MOUNTAIN)
4/3 INF (OPN IRON MOUNTAIN)
1/1 ARMD CAV SQDN (OPN IRON MOUNTAIN)

1st MAW
MAG-12

MAG-13
VMFA-115 (F-4B)
VMFA-314 (F-4B)
VMFA-122 (F-4B)
VMA-311 (A-4E)

USMC 5,215
USN 116
USA 24,391

OKINAWA

HQ, I MEF
3D MARDIV (-) (REIN)(TF-79)
11th MEB (TF-79.1)

4TH MARINES
1/4
2/4
3/4

9TH MARINES
3/9

MAG-36
VMGR-152 (KC-130F)
VMO-6 (OV-10A/UH-1E)
HMH-462 (CH-53A)

3D FSR (3,456) (50)
MCB CAMP BUTLER/NON FMF (915) (25)
Non-Deployable Casuals (148)
SVN-Originated Patients (0)

USMC 19,200
USN 934
ACTUALS CHARGED AGAINST PROGRAM VIII AS OF 5FEB70 18,580 424
(14,061) (349)

USMC RVN RECAP

	USMC	USN
OSD PROGRAM VIII CEILING	55,510	2,233
ACTUALS CHARGED AGAINST PROGRAM VIII AS OF 16FEB70	52,530	2,040
III MAF	52,222	2,040
SU#1 1ST ANGLICO	(212)	(14)
OTHER	308	
MACV STAFF/MACV FIELD	(272)	
NAVALVGRU/NAVY UNITS	(36)	

I CORPS RECAP

US MARINE CORPS	(12 BNS)	52,222
US ARMY	(25 BNS)	73,849
US NAVY		16,954
US AIR FORCE		8,194
ROKMC	(4 BNS)	6,148
RVNAF	(36 BNS)	153,895
ARVN/ABN	(36 BNS)	(74,634)
VNMC		
VNN		(2,100)
VNAF		(3,408)
VNRF		(37,403)
VNPF		(36,350)
I CORPS TOTAL	77 BNS	311,262

SLF 7TH FLEET

	USMC	USN
BRavo: BLT 2/9	1,847	60
HMM-165 ENR SUBIC BAY ETA: 22FEB70		
ALFA: BLT 1/9	1,868	85
HMM-164 AT OKINAWA		

MOVEMENTS

Det 12th Mar and "D" Co, 3d Recon Bn.
At Fuji for training.

VMA-211 w/12 A-4E A/C commenced redeployment. ETA IWAKUNI 18FEB70.

JAPAN

	USMC	USN
OSD PROGRAM VIII CEILING	3,600	45
ACTUALS CHARGED AGAINST PROGRAM VIII AS OF 5FEB70	3,749	34

1ST MAW (REAR)

MAG-15 (2,553) (34)
VMFA-232 (F-4J)
VMFA-334 (F-4J)
VMA(AW)-533 (A-6A)
VMA-211 (A-4E)
(Less command)

*Does NOT include 243 hospitalized SVN-Originated Patients.

Non FMF (1,196)

* Includes only U. S. Navy Personnel organic to FMF Units.
Includes SU#1 and 1st ANGLICO at various locations throughout SVN.
• Latest Change

Unclassified
UNCLASSIFIED

MARINE CORPS
FEB 18 1970
REFERENCE BRANCH

Unclassified

UNCLASSIFIED

SUMMARY OF MAJOR US AND FWMAF OPERATIONS

OPERATION (DATE COMMENCED)	UNITS INVOLVED	LOCATION	CASUALTIES AS OF: 182400H FEB70		
			FRIENDLY		ENEMY
			KIA	WIA	KIA.
GREENE RIVER (19JAN70)	1ST BDE, 5TH INF DIV (MECH); 4 USA BNS	EASTERN QUANG TRI PROVINCE	4	114	61
RANDOLPH GLEN (7DEC69)	101ST ABN DIV (AM); 9 USA BNS	QUANG TRI & THUA THIEN PROVINCES	60	267	418
VICTORY DRAGON XIX (1JAN70)	2D ROKMC BDE; 4 ROKMC BNS	HOI AN AREA	1	12	18
FREDERICK HILL (18MAR69)	196TH INF BDE; 3 USA BNS	QUANG TIN PROVINCE	370	2,343	4,507
GENEVA PARK (18JUL69)	198TH INF BDE; 2 USA BNS	QUANG TIN & QUANG NGAI PROVINCES	126	860	1,186
NANTUCKET BEACH (20JUL69)	198TH INF BDE; 1 USA BN	CENTERED 15 KM NE OF QUANG NGAI CITY	24	220	250
IRON MOUNTAIN (18MAR69)	11TH INF BDE; 5 USA BNS	QUANG NGAI PROVINCE	288	1,672	2,503

• - ADJUSTED
- FINAL CUMULATIVE CASUALTIES

UNCLASSIFIED

Unclassified

UNCLASSIFIED

USMC/ENEMY CASUALTIES IN RVN

18 FEBRUARY 1970

USMC BATTLE CASUALTIES

KIA/DOW	WIA(EVAC)	WIA(RTD)	MIA/PW
12,474	48,892	35,837	81/21

USMC CASUALTY FIGURES ARE PROVIDED DAILY BY HQMC CASUALTY SECTION (CODE DNA) AND REFLECT ALL CASUALTIES REPORTED AS OF 17FEB70.

USMC NON-BATTLE CASUALTIES

DEAD	INJURED	MISSING
1,507	1,822	13

FIGURES INDICATED AS INJURED ARE ONLY THOSE IN SERIOUS/CRITICAL INJURY OR DISEASE CATEGORY AND DO NOT INCLUDE THOSE OF A MINOR NATURE

USMC INFLECTED ENEMY CASUALTIES

KIA	PW	WPNS
80,636	4,200	29,811

ENEMY CASUALTIES ARE COMPILED DAILY FROM THE III MAF HISSUM AND ARE RECONCILED MONTHLY WITH THE FMFPAC SUMMARY OF USMC OPERATIONS IN RVN

TYPICAL DISPOSITION OF 100 USMC WIA *

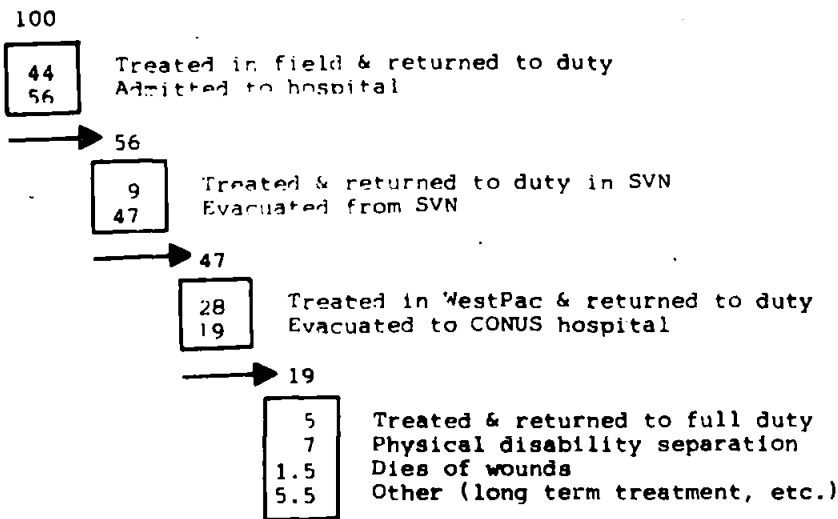

*54,081 CASUALTIES, JAN67-DEC68.

Unclassified

UNCLASSIFIED

UNCLASSIFIED

SPECIAL LANDING FORCE, 7TH FLEET

SLF BRAVO

18 FEBRUARY 1970

TASK GROUP 79,5 CTG: COL G. G. CHAMBERS JR	STRENGTH				ARMS & EQUIPMENT	LOCATION
	USMC		USN			
	OFF	ENL	OFF	ENL		
UNITS EMBARKED					8 M29 81MM MORTARS 3 M40 106MM RR 6 M30 107MM MORTARS 4 M101A1 105MM HOW 4 M48 90MM TANKS 5 LVTP-5	ENROUTE SUBIC ETA: 22FEB70
SLF HQS DET						
BLT 2/9 (LTCOL J. R. VANDENELZEN)	52	1500	1	56		SHIPPING USS NEW ORLEANS (LPH-11) USS THOMASTON (LSD-28) USS VANCOUVER (LPD-2) USS WHITFIELD CTY (LST-1169)
2D BN, 9TH MARINES						
W/2/12						
E/2/12						
PLAT, CO "B", 1ST AMTRAC						
PLAT, CO "C", 3D ENGR BN						
PLAT, CO "C", 3D SP BN						
PLAT, CO "C", 3D MT BN						
PLAT, CO "C", 3D RECON BN						
PLAT, CO "A", 3D TK BN						
CLEAR PLAT, CO "B", 3D MED						
SQD, MP CO, 3D MARDIV						
DET, HQBN, 3D MARDIV						
DET, COMM PLT, HQCO, 9TH MAR						
DET, COMM SPT CO, 7TH COMM						
DET, 3D DENTAL CO						
LSU						
HMM-165 (LTCOL P. H. MITCHELL)	69	226	1	2		SUPPLIES CLASS I CLASS II CLASS III CLASS IV CLASS V
TOTALS	121	1726	2	58	AIRCRAFT 18/CH-46A	

SLF ALFA

18 FEBRUARY 1970

TASK GROUP 79,4 CTG: COL C. W. BOYD, JR.	STRENGTH				ARMS & EQUIPMENT	LOCATION
	USMC		USN			
	OFF	ENL	OFF	ENL		
UNITS EMBARKED					12 M10 60MM MORTARS 8 M29 81MM MORTARS 8 M40 106 MM RR 6 M30 107 MM MORTARS 6 M101A1 105 MM HOW 5 M48 90MM TANKS	AT OKINAWA
SLF HQS DET						
BLT 1/9 (LTCOL D. J. MC ADAMS)	54	1596	6	76		SHIPPING
1ST BN, 9TH MARINES						
MORT BTRY, 2/12						
BTRY "D" (REIN), 2/12						
PLAT, CO "B", 1ST AMTRAC BN						
PLAT, CO "C", 3D ENGR BN						
PLAT, CO "C", 3D SP BN						
PLAT, CO "A", 3D MT BN						
PLAT, CO "C", 3D RECON BN						
PLAT, CO "C", 3D TK BN						
CLEAR PLT, CO "B", 3D MED BN						
SQD, MP CO, 3D MARDIV						
DET, HQ BN						
DET, COMM PLT HQ CO, 9TH MAR						
DET, 3D DENTAL CO						
LSU						
DET BMU NBG						
HMM-164 (LTCOL R. D. FOWNER)	41	177	1	2		SUPPLIES CLASS I 30 DAYS CLASS II 30 DAYS CLASS III 30 DAYS CLASS IV 30 DAYS CLASS V 30 DAYS
TOTALS	95	1773	7	78	AIRCRAFT 19/CH-46A's	

UNCLASSIFIED

Unclassified

18 FEBRUARY 1970

~~CONFIDENTIAL~~
UNCLASSIFIED

MARINE CORPS COMMAND CENTER

MILITARY FORCES IN RVN *

RVN ARMED FORCES (RVNAF)

ARMY (ARVN)	416,278
NAVY (VNN)	30,143
AIR FORCE (VNAF)	36,469
MARINE CORPS (VNMC)	11,528
REGIONAL FORCES (RF)	260,455
POPULAR FORCES (PF)	214,383
TOTAL RVNAF	969,256

UNITED STATES FORCES

ARMY	333,615
NAVY	29,128
AIR FORCE	56,553
MARINE CORPS	52,530
COAST GUARD	369
TOTAL U.S.	472,195

FREE WORLD MILITARY ASSISTANCE FORCES (FWMAF)

REPUBLIC OF KOREA	48,871
AUSTRALIA	7,696
PHILIPPINES	142
THAILAND	11,568
NEW ZEALAND	557
REPUBLIC OF CHINA	28
SPAIN	11
TOTAL FWMAF	68,873

TOTAL FORCES IN RVN 1,510,324

SOURCE: RVNAF MACV MONTHLY STRENGTH REPORT. ALL OTHER:
MACV WEEKLY STRENGTH REPORT AS OF 2400, 12FEB70.
USMC STRENGTH: MACV WEEKLY STRENGTH REPORT AS
ADJUSTED BY MACV RPT OF ARR/DEP AS OF 2400, 16FEB70.

UNCLASSIFIED
Unclassified

UNCLASSIFIED

VIETNAM REFERENCE DATA

VIETNAM GEOGRAPHIC DATA

2 APRIL 1969

	LENGTH (MI)	WIDTH (MI)	AREA (SQ MI)	POPULATION
NORTH VIETNAM	425*	44-389	63,000	18,297,000
DEMILITARIZED ZONE	44	MAX 6		
SOUTH VIETNAM	823*	30-130	66,700	17,196,000
I CORPS	220*	30-75	10,700	2,755,800
II CORPS	315*	45-130	31,300	3,075,600
III CORPS	90*	55-115	10,100	5,400,100
IV CORPS	195*	35-115	14,600	5,964,500

* Coastal Arc

I CORPS GEOGRAPHIC DATA

PROVINCES	AREA (SQ MI)	POPULATION	VILLAGES
QUANG TRI	1,820	294,800	84
THUA THIEN	1,900	447,500	95
QUANG NAM	2,500	558,500	141
QUANG TIN	1,890	411,900	70
QUANG NGAI	2,690	603,000	159
CITIES			
QUANG TRI		(13,000)	
HUE		150,000	
DANANG		290,100	
HOI AN		(21,000)	
TAM KY		(13,000)	
QUANG NGAI		(12,000)	

CITY POPULATIONS IN PARENS () ARE INCLUDED IN APPROPRIATE PROVINCE TOTAL

19 FEBRUARY 1970

PACIFICATION STATUS I CTZ AS OF: 31 DEC 69

SECURE POPULATION:	93.6%
CONTESTED POPULATION:	2.3%
VC CONTROLLED POPULATION:	4.1%

UNCLASSIFIED

~~CONFIDENTIAL~~
UNCLASSIFIED

MARINE CORPS COMMAND CENTER

SELECTED PERSONNEL AND AIRCRAFT DATA

PERSONNEL

19 FEBRUARY 1970

	STRENGTH	PERCENT USMC	PERCENT FMF	PERCENT FMFPAC
USMC TOTAL	300,982 *	100.00		
FLEET MARINE FORCES	153,729	51.08	100.00	
FMF ATLANTIC	45,696 \$	15.18	29.73	
FMF PACIFIC	107,599 #	35.90	70.27	
VIETNAM	52,480 ¢	17.44	34.14	48.77

SOURCE: * MONTHLY USMC PERSONNEL ALLOCATION REPORT OF 30NOV69.
\$ MCCC UNIT REPORT OF 4FEB70.
MCCC UNIT REPORT OF 21JAN70.
¢ MACV WEEKLY STRENGTH REPORT AS OF 2400, 12FEB70 AS ADJUSTED BY THE MACV DAILY RPT OF ARR/DEP AS OF 2400, 17FEB70.

AIRCRAFT

5 FEBRUARY 1970

	FIXW	HELO	TOTAL	PERCENT USMC	PERCENT FMF	PERCENT FMFPAC
USMC TOTALS	1013	569	1582	100.00		
FLEET MARINE FORCES	763	543	1306	82.55	100.00	
FMF ATLANTIC	303	156	459	29.01	35.15	
FMF PACIFIC	460	387	847	53.54	64.85	
VIETNAM	156	178	334	21.11	25.57	39.43

SOURCE: MARINE CORPS COMMAND CENTER UNIT REPORT OF 31DEC69.

UNCLASSIFIED

~~CONFIDENTIAL~~

~~CONFIDENTIAL~~

UNCLASSIFIED

FLEET MARINE FORCE DEPLOYMENTS

19 FEBRUARY 1970



1ST MAR BRIG
HAWAII

I MEF
OKINAWA
& JAPAN

10TH MARINES
DET, 2D FAG
DET 1, HMM-264
AT VIEQUES FOR FIREX. PLT, 2D ANGLICO
ETD 25MAR70 FOR
CAMLEJ.

GTMO AUGMENT
2D BN, 8TH MAR
BTRY B/1/10
PLT, 2D TK BN
DET, FSR

LANFORCARIB 1-70
BLT 3/2 & HMM-261
ENR LIBERTY PORTS
ETA: 20FEB70

LANFOR6THFLT 3-69
ENR ATHENS
ETA: 210600Z FEB70

III MAF
RVN

SLF, 7TH FLEET
SLF ALFA
AT OKINAWA

SLF BRAVO
ENR SUBIC BAY
ETA: 22FEB70

DET, 12THMAR "D" CO,
3D RECON BN AT FUJI
FOR TRNG.

DISTRIBUTION OF MAJOR FMF UNITS

	INF BNS	VMFA	VMA	VMA(AW)	VMCI	HMM	HMH	HML	VMO	VMGR
WESTPAC	18	5	2	3	1	6	2	2	2	1
RVN	(12)	(3)	(1)	(2)	(1)	(4)	(1)	(2)	(2)	
OKINAWA/JAPAN	(4)	(2)	(1)*	(1)			(1)		(1)	(1)
ASSIGNED TO SLF'S	(2)					(2)				
MIDPAC	1	2								
HAWAII AFLOAT	(1)	(2)								
EASTPAC	2	**3	2		1	2	2	1		1
WEST COAST AFLOAT	(2)	(3)	(2)		(1)	(2)	(2)	(1)		(1)
ATLANTIC	8	5	2	3	1	4	2		1	1
EAST COAST	(6)	(5)	(2)	(3)	(1)	(3)	(2)		(1)	(1)
CARIBBEAN	(2)					(1)				
EUROPE	1									
MEDITERRANEAN	(1)									
GRAND TOTAL	30	15	6	6	3	12	6	3	3	3

* ENROUTE IWAKUNI.
** VMFA-323 IN CADRE STATUS.

UNCLASSIFIED

Unclassified

SELECTED UNIT COMMANDERS AND STAFF OFFICERS

19 FEBRUARY 1970

UNCLASSIFIED

HEADQUARTERS III MARINE AMPHIBIOUS FORCE

COMMANDING GENERAL	LTGEN H. NICKERSON, JR.
DEPUTY COMMANDER	MGEN G. S. BOWMAN, JR.
CHIEF OF STAFF	BGEN L. J. DULACKI
DEPUTY CHIEF OF STAFF	COL S. A. DRESSIN
ACOS, G-1	COL R. L. PARNELL, JR.
ACOS, G-2	COL E. W. DZIALO
ACOS, G-3	BGEN T. H. MILLER, JR.
ACOS, G-4	COL W. F. SIMLIK
ACOS, G-5	COL C. J. PEABODY
ACOS, G-6	LTCOL R. S. BARRY
ACOS, COMPT	LTCOL J. M. VOSMIK
DEP C/S SPECIAL PROJECTS	COL A. T. WOOD

CG XXIV CTZ	LTGEN M. ZAIS USA
DEP C/S XXIV CTZ	COL M. M. COOK USMC

ACOS, CAP	COL T. E. METZGER
COMMANDING OFFICER, 1ST CAG	LTCOL D. F. SEILER
COMMANDING OFFICER, 2ND CAG	LTCOL D. R. CHRISTENSEN
COMMANDING OFFICER, 3RD CAG	LTCOL C. M. DANIELS
COMMANDING OFFICER, 4TH CAG	LTCOL J. J. KEENAN
1ST RADIO BATTALION	LTCOL D. M. HOPKINS

1ST MARINE DIVISION

COMMANDING GENERAL	MGEN E. B. WHEELER
AAC	BGEN W. F. DOEHLER
CHIEF OF STAFF	COL C. E. WALKER
ACOS, G-1	COL R. E. BARDE
ACOS, G-2	COL E. A. WILCOX
ACOS, G-3	COL F. H. WALDROP
ACOS, G-4	COL N. A. CANZONA
ACOS, G-5	COL L. S. HULLIER
ACOS, COMPT	LTCOL N. M. LASLAVIC, JR.
CEO	COL C. G. DAHL
<u>1ST MARINES</u>	
COMMANDING OFFICER	COL E. A. WILCOX
1ST BATTALION	LTCOL G. S. DELCUZE
2ND BATTALION	LTCOL W. V. H. WHITE
3RD BATTALION	LTCOL F. M. BOYD
<u>5TH MARINES</u>	
COMMANDING OFFICER	COL R. F. ESTEY
1ST BATTALION	LTCOL J. K. GRIFFIS, JR.
2ND BATTALION	LTCOL F. LEDER
3RD BATTALION	LTCOL J. S. GESTSON
<u>7TH MARINES</u>	
COMMANDING OFFICER	COL G. S. CODISPOTI
1ST MARINES	LTCOL C. G. COOPER
2ND MARINES	LTCOL A. E. FOLSOM
3RD MARINES	LTCOL R. G. KUMMEROW
<u>26TH MARINES</u>	
COMMANDING OFFICER	COL J. E. HARRELL
1ST BATTALION	LTCOL J. C. GOODIN
2ND BATTALION	LTCOL P. L. HUMPHREY
3RD BATTALION	LTCOL J. J. UNTERKOFELER
<u>11TH MARINES</u>	
COMMANDING OFFICER	COL D. D. EZELL
1ST BATTALION	LTCOL J. D. SHOUP
2ND BATTALION	LTCOL V. WEAVER
3RD BATTALION	LTCOL K. N. MUELLER
4TH BATTALION	LTCOL J. F. BURKE, JR.
1ST BN, 13TH MAR	LTCOL D. H. STRAIN
HQS BATTALION	COL W. C. PATTON
1ST ENGR BATTALION	LTCOL N. F. GLOWICKI
1ST RECON BATTALION	LTCOL W. C. DRUMWRIGHT
1ST MT BATTALION	LTCOL M. S. SHIMANOFF
1ST SP BATTALION	COL R. F. ARMSTRONG
1ST MED BATTALION	CAPT(MC) J. W. LEA
1ST TK BATTALION	MAJOR J. I. LOUDER
3RD AMTRAC BATTALION	LTCOL D. G. MEHARGUE
7TH ENGR BATTALION	LTCOL W. G. BATES
9TH ENGR BATTALION	LTCOL E. K. MAXWELL
11TH MT BATTALION	LTCOL W. R. KEPHART

FORCE LOGISTICS COMMAND

COMMANDING GENERAL	BGEN M. J. PADALINO
CHIEF OF STAFF	COL J. L. TOBIN
ACOS, G-1	LTCOL J. E. REDELFS
ACOS, G-2	LTCOL R. L. SOLZE
ACOS, G-3	LTCOL W. W. STORM, III
ACOS, G-4	LTCOL M. H. IVINS
ACOS, G-5	MAJOR R. E. JOHNSON
ACOS, COMPT	LTCOL F. R. WARREN
CEO	MAJOR R. D. HAGAN
<u>1ST FORCE SERVICE REGT</u>	
H&S BATTALION	LTCOL L. R. WEBB
SUPPLY BATTALION	COL R. W. CALVERT
MAINT BATTALION	LTCOL E. C. MORRIS
FLSG-B/1ST SERV BN	COL D. E. MORIN
5TH COMM BATTALION (REIN)	LTCOL D. E. SHATZER
7TH MT BATTALION	LTCOL R. L. PRATHER
1ST MP BATTALION	LTCOL S. D. THOMAS
3RD MP BATTALION	LTCOL C. FIMIAN

UNCLASSIFIED

MARINE CORPS COMMAND CENTER

UNCLASSIFIED

SELECTED UNIT COMMANDERS AND STAFF OFFICERS

19 FEBRUARY 1970

1ST MARINE AIRCRAFT WING		3D MARINE AIRCRAFT WING	
COMMANDING GENERAL AWC	MGEN W. G. THRASH	COMMANDING GENERAL AWC	MGEN R. G. OWENS, JR.
CHIEF OF STAFF	BGEN R. H. SPANJER	CHIEF OF STAFF	BGEN J. A. FEELEY, JR.
ACOS, G-1	COL R. W. TELLER	ACOS, G-1	COL H. N. MEHAFFEY
ACOS, G-2	COL G. S. STEWART	ACOS, G-2	LTCOL L. A. GULLING
ACOS, G-3	COL J. R. WEAVER	ACOS, G-2	COL R. J. GRAHAM
ACOS, G-4	COL R. L. LAMAR	ACOS, G-3	COL D. WILKER
ACOS, COMPT	COL W. C. MCGRAW	ACOS, G-4	
CEO	COL E. J. ARTNAK		
	LTCOL T. KALUS		
<u>MWHG-1</u>		<u>MWHG-3</u>	
COMMANDING OFFICER	COL L. J. STIEN	COMMANDING OFFICER	COL G. L. LILLICH
H&MS-1	MAJ W. S. HUMBERT	H&MS-3	LTCOL J. B. LAVELLE
MWFS-1	LTCOL N. F. SCHNIPPEL, JR.	MWFS-3	MAJOR J. S. LOOP
MWCS-1	MAJOR A. B. RAY	MWCS-3	MAJOR D. B. NEWTON
<u>MWSG-17</u>		<u>MHTG-30</u>	
COMMANDING OFFICER	COL H. L. JENSEN	COMMANDING OFFICER	COL A. F. GARROTTO
H&MS-17	LTCOL D. SERRIN	H&MS-30	LTCOL R. W. CREIGHTON
WERS-17	MAJOR W. F. FARLEY	HMHT-301	LTCOL L. W. JARMAN
		HMMT-302	LTCOL K. D. VANEK
<u>MACG-18</u>		<u>MAG-33</u>	
COMMANDING OFFICER	COL S. G. DUNWIDDIE, JR.	COMMANDING OFFICER	COL F. N. PIPPIN
H&MS-18	LTCOL H. E. HOPPEYER, JR.	H&MS-33	LTCOL R. H. HUTCHINSON
MACS-4	LTCOL R. W. MOLYNEUX, JR.	MABS-33	MAJOR J. E. KEHRLE
		VMCJ-3	LTCOL R. E. PERCIVAL
MASS-3	LTCOL J. H. DUBOIS	VMA-214	LTCOL W. R. SMITH
		VMFA-323 (CADRE)	MAJ K. A. ZIMMERMAN II
<u>MAG-11</u>		VMFAT-101	LTCOL R. R. NORTON
COMMANDING OFFICER	COL N. E. HEFFERNAN	VMFA-531	LTCOL J. L. THATCHER
H&MS-11	LTCOL R. F. HEBERT	VMFA-542	LTCOL K. A. SMITH
MABS-11	LTCOL P. A. MANNING	VMA-223	LTCOL J. W. IAZZO
VMCJ-1	LTCOL B. W. FARLEY		
VMA(AW)-225	LTCOL J. J. METZKO	<u>MWSG-37</u>	
		COMMANDING OFFICER	COL F. E. WILSON
VMA(AW)-242	LTCOL S. P. LEWIS	H&MS-37	LTCOL D. L. RICE
VMO-2	LTCOL J. M. MORIARITY	WERS-37	LTCOL R. W. DUPHINEY
		VMGR-352	LTCOL H. D. STOTT
<u>MAG-12</u>		<u>MAG-38</u>	
COMMANDING OFFICER	COL P. B. HENLEY	COMMANDING OFFICER	LTCOL T. I. GUNNING
H&MS-12	LTCOL J. J. WENT	H&MS-38	MAJOR F. L. HARDING
MABS-12	LTCOL G. J. ERTLMEIR	SU#1, H&MS-38	MAJOR D. V. STOWELL
		MACS-1	MAJ C. F. KELLENBARGER
VMA-211	LTCOL L. GASPERINE, JR.	MACS-3	LTCOL T. M. KAUFFMAN
		MACS-7	LTCOL D. E. ROBERTS
<u>MAG-13</u>		1STLAAM BN	MAJOR E. L. HOUSE, JR.
COMMANDING OFFICER	LTCOL T. E. MURPHREE	2NDLAAM BN	MAJOR H. J. BALDWIN, JR.
H&MS-13	MAJOR F. J. HORACK		
MABS-13	MAJOR R. D. REVIE	<u>MAG-56</u>	
VMFA-115	LTCOL D. P. BOWEN	COMMANDING OFFICER	COL M. D. PORTER
VMFA-314	LTCOL T. J. KELLY	H&MS-56	LTCOL G. H. BUCKNER II
VMA-311	MAJOR A. R. HICKLE	MABS-56	LTCOL F. L. YOHE
VMFA-122	LTCOL R. E. HOWARD, JR.	HMH-363	LTCOL R. P. BRAY
		HML-267	LTCOL J. M. BLANC
<u>MAG-16</u>		HMH-361	LTCOL R. A. GOVONI
COMMANDING OFFICER	COL J. P. BRUCE	HMM-163	LTCOL F. A. MATHEWS
H&MS-16	MAJOR M. T. HORNSBY	HMM-265	LTCOL R. C. COURTNEY
MABS-16	LTCOL P. C. SCAGLIONE		
		<u>MCCRTG-10</u>	
HMH-453	LTCOL C. A. BLOCK	COMMANDING OFFICER	COL G. FINK
HML-167	LTCOL J. E. WEBER	H&MS-10	MAJ I. L. DRIEFER
HMM-364	LTCOL C. R. DUNBAUGH	VMAT-102	LTCOL B. A. SCHAFFER
HMM-263	LTCOL W. R. LEDBETTER, JR.	VMT-103	LTCOL M. T. GARRISON
HMM-161	MAJOR B. H. MANN		
HMM-262	LTCOL R. A. BANCROFT		
HML-367	LTCOL W. G. CRETNEY		

UNCLASSIFIED

UNCLASSIFIED

DISTRIBUTION OF MAJOR FMFPAC TACTICAL UNITS

19 FEBRUARY 1970

UNIT	CHU LAI	DANANG	NoICTZ/DMZ	OKINAWA	JAPAN	HAWAII	EASTPAC	OTHER	NOTE
1ST MARINES		1/1, 2/1, 3/1							
3D MARINES						1/3	2/3, 3/3		
4TH MARINES				1/4, 2/4, 3/4					
5TH MARINES		1/5, 2/5, 3/5							
7TH MARINES		1/7, 2/7, 3/7							
9TH MARINES				3/9				1/9, 2/9	1
26TH MARINES		1/26, 2/26, 3/26							
MAG-11		VMCJ-1 VMA(AW)-225 VMA(AW)-242 VMO-2							
MAG-12	VMA-211								
MAG-13	VMA-311 VMFA-115 VMFA-122 VMFA-314								
MAG-16		HML-167 HML-367 HMM-161 HMM-262 HMM-263 HMM-364 HMM-463							
MAG-36				VMO-6 HMM-462				HMM-164 HMM-165	1 1
MAG-15					VMFA-232 VMFA-334 VMA(AW)-533				
MAG-24						VMFA-212 VMFA-235			
MAG-33							VMA-214 VMA-223 VMCJ-3 VMFA-323 * VMFA-531 VMFA-542		2 2
MAG-56							HML-267 HMM-163 HMM-265 HMM-361 HMM-363		2

DISTRIBUTION OF MAJOR GROUND EQUIPMENT

EQUIPMENT	T/E AUTH	CHU LAI	DANANG	NoICTZ/DMZ	OKINAWA	HAWAII	EASTPAC	OTHER	NOTE
60mm MORTAR M19	254		144		60	12	24	12	1
81mm MORTAR M29	16B		96		40	8	16	8	1
106mm RR M40A1C	16B		96		40	8	16	8	1
107mm MORTAR M30	42		24		6	6		6	1
105mm HOW TD M101A1	136		72		30	6	12	6	1
155mm HOW SP M109	42		24		12		6		
175mm GUN(SP)	18		12	6					
81n HOW SP M110	14		12	2					
ONTOS M50A1	115		15		75		15	10	1
90mm TANK M48A3	126		73		36		17		1
120mm TANK M103A2	17						17		
FLAME TANK M67A2	27		12		9		6		
LVTH6	18		6		12				
LVTP5	280		112		113		44	11	1
LVTE1	24		8		8		8		
HAWK LAUNCHERS	36						36		

NOTES: 1. UNITS/EQUIPMENT IN OTHER ASSIGNED TO SLF'S
2. ENROUTE CONUS
3. ENROUTE OKINAWA
* CADRE

Unclassified

UNCLASSIFIED

~~CONFIDENTIAL~~
UNCLASSIFIED

DISTRIBUTION OF AIRCRAFT, FMFPAC

19 FEBRUARY 1970

UNIT	DANANG	CHU LAI	PHU BAI	OKINAWA	JAPAN	HAWAII	EASTPAC	OTHER
HQ SQDN, FMFPAC						6/T-1A 1/C-54R 1/C-47J		
MAG-11 H&MS-11	8/TA-4F 1/C-117D							
VMCJ-1	9/RF-4B							
VMA(AW)-242	8/EA-6A							
VMA(AW)-225	12/A-6A							
VMO-2	11/A-6A							
	19/OV-10A							
MAG-12 H&MS-12		1/C-117D						
VMA-211		19/A-4E						
MAG-13 H&MS-13		1/C-117D						
VMA-311		19/A-4E						
VMFA-115		14/F-4B						
VMFA-314		15/F-4B						
VMFA-122		11/F-4B						
MAG-15 H&MS-15					1/C-54Q 1/C-117D 3/TA-4F 1/C-54S			
VMFA-232					14/F-4J			
VMFA-334					12/F-4J			
VMA(AW)-533					11/A-6A			
MAG-16 H&MS-16	2/C-117D 1/CH-46A							
HML-167	25/UH-1E							
HML-267	24/AH-1G							
HMM-263	21/CH-46D							
HMM-161	21/CH-46D							
HMM-262	21/CH-46D							
HMM-364	20/CH-46D							
HMH-463	21/CH-53A/T							
MCCRTG-10 H&MS-10								
VMAT-102							26/A-4C	
VMT-103							16/TA-4F	
MWSG-17 H&MS-17	3/US-2B 3/C-117D							
MHTG-30 H&MS-30							5/CH-46D	
HMHT-301							14/CH-53A	
HMHT-302							18/CH-46D	
MAG-33 H&MS-33							2/F-4B 6/TA-4F	
VMA-223							20/A-4E	**
VMCJ-3							8/RF-4B 1/F-4B 12/EF-10B 23/A-4C	
VMA-214								
VMFA-323 (CADRE)							12/F-4B	
VMFA-531							23/F-4B	
VMFAT-101							15/F-4B	**
VMFA-542								
MAG-36 H&MS-36				1/C-117D 1/CH-46A				
VMGR-152				12/KC-130E				
HMM-165								18/CH-46A *
HMM-164								19/CH-46A *
HMH-462				20/CH-53A				
VMO-6				11/UH-1E				
				18/OV-10A				

NOTES: * ASSIGNED TO SLF's
** ENROUTE CONUS

~~CONFIDENTIAL~~
UNCLASSIFIED

Unclassified

~~SECRET~~

UNCLASSIFIED

MARINE CORPS COMMAND CENTER

MARINE CORPS PERSONNEL IN RVN

19 FEBRUARY 1970

	OFF	ENL	TOTAL
* III MAF.	3,485	48,687	52,172
DANANG	(2,986)	(42,292)	(45,278)
CHU LAI	(391)	(4,824)	(5,215)
PHU BAI	(73)	(868)	(941)
DONG HA	(35)	(703)	(738)
SU #1, 1ST ANGLICO (AT VARIOUS LOCATIONS SVN)	((21))	((191))	((212))
OTHER USMC PERSONNEL	159	149	308
MACV STAFF/MACV FIELD	(136)	(136)	(272)
NAVAJUGRU/NAVY UNITS	(23)	(13)	(36)
USMC IN RVN CHARGED AGAINST PROGRAM VIII	3,644	48,835	52,480
U. S. NAVY, III MAF.	256	1,784	2,040

* AS REPORTED BY III MAF DAILY ADMIN SITREP # 42 AS OF 2400, 10FEB70 AND THE MACV WEEKLY STRENGTH REPORT, AS OF 2400, 12FEB70 AS ADJUSTED BY MACV DAILY RPT OF ARR/DEP AS OF 2400,

Unclassified

UNCLASSIFIED

MARINE CORPS COMMAND CENTER
WESTPAC UNIT LOCATIONS

19 FEBRUARY 1970

QUANG TRI (QUANG TRI)	USMC 738 USN 37 USA 5,826
1ST BDE, 5TH INF DIV (MECH) 1/77 ARMOR (OPN GREENE RIVER) 1/61 INF (MECH) (OPN GREENE RIVER) 1/11 INF (OPN GREENE RIVER) 3/5 ARMD CAV SQDN (OPN GREENE RIVER)	

THUA THIEN HQ, XXIV CORPS (PHU BAI) HQ, 101st ABN DIV (AM)	USMC 941 USN 46 USA 26,259
1ST BDE, 101ST ABN DIV (AM) 1/327 INF (AM) (OPN RANDOLPH GLEN) 2/327 INF (AM) (OPN RANDOLPH GLEN) 2/502 INF (AM) (OPN RANDOLPH GLEN)	
2D BDE, 101ST ABN DIV (AM) 1/501 INF (AM) (OPN RANDOLPH GLEN) 2/501 INF (AM) (OPN RANDOLPH GLEN) 1/502 INF (AM) (OPN RANDOLPH GLEN)	
3D BDE, 101ST ABN DIV (AM) 1/506 INF (AM) (OPN RANDOLPH GLEN) 2/506 INF (AM) (OPN RANDOLPH GLEN) 3/187 INF (AM) (OPN RANDOLPH GLEN)	

QUANG NAM HQ, III MAF	USMC 45,278 USN 1,841 USA 1,110 ROKMC 7,145
HQ, 1st MAR DIV (DANANG)	HQ 1st MAF MAG-11
1ST MARINES 1/1 2/1 3/1	VMA(AW)-242 (A-6A) VMA(AW)-225 (A-6A) VMCJ-1 (RF-4/EA-6/EF-10) VMO-2 (OV-10A)
5TH MARINES 1/5 2/5 3/5	MAG-16 HML-367 (AH-1G) HML-167 (UH-1E) HMH-463 (CH-53A) HMM-364 (CH-46D) HMM-263 (CH-46D) HMM-262 (CH-46D) HMM-161 (CH-46D)
7TH MARINES 1/7 2/7 3/7	
26TH MARINES 1/26 2/26 3/26	
	2d ROKMC BDE 1/2 (OPN VICTORY DRAGON XIX) 2/2 (OPN VICTORY DRAGON XIX) 3/2 (OPN VICTORY DRAGON XIX) 5/2 (OPN VICTORY DRAGON XIX)

QUANG TIN/QUANG NGAI HQ 23d INF DIV (AMERICA) (CHU LAI)	USMC 5,215 USN 116 USA 24,391
196TH LT INF BDE 2/1 INF (OPN FREDERICK HILL) 4/31 INF (OPN FREDERICK HILL) 3/21 INF (OPN FREDERICK HILL) 1/46 INF	1st MAF MAG-12
198TH LT INF BDE 1/6 INF (OPN GENEVA PARK) 1/52 INF (OPN GENEVA PARK) 5/46 INF (OPN NANTUCKET BEACH)	MAG-13 VMFA-115 (F-4B) VMFA-314 (F-4B) VMFA-122 (F-4B) VMA-311 (A-4E)
11TH INF BDE 1/20 INF (OPN IRON MOUNTAIN) 4/21 INF (OPN IRON MOUNTAIN) 3/1 INF (OPN IRON MOUNTAIN) 4/3 INF (OPN IRON MOUNTAIN) 1/1 ARMD CAV SQDN (OPN IRON MOUNTAIN)	

OKINAWA HQ, I MEF 3D MARDIV (-) (REIN)(TF-79) 11th MEB (TF-79.1)	USMC 19,200 USN 934 USA 18,580 ROKMC 14,061
4TH MARINES 1/4 2/4 3/4	9TH MARINES 3/9 MAG-36 VMGR-152 (KC-130F) VMO-6 (OV-10A/UH-1E) HMH-462 (CH-53A)
	3D FSR (3,456) MCB CAMP BUTLER/NON FMF (915) Non-Deployable Casuals (148) SVN-Originated Patients (0)

USMC RVN RECAP	USMC	USN
OSD PROGRAM VIII CEILING	55,510	2,233
ACTUALS CHARGED AGAINST PROGRAM VIII AS OF 17FEB70	52,480	2,040
III MAF	52,472	2,040
SUM#1 1st ANGLICO	(212)	(14)
OTHER	308	
MACV STAFF/MACV FIELD	(272)	
NAVAVGRU/NAVY UNITS	(36)	

I CORPS RECAP	
US MARINE CORPS	(12 BNs) 52,172
US ARMY	(25 BNs) 73,849
US NAVY	16,954
US AIR FORCE	8,194
ROKMC	(4 BNs) 6,148
RVNAF	(36 BNs) 153,895
ARVN/ABN	(36 BNs) (74,634)
VNMC	
VNN	(2,100)
VNAF	(3,408)
VNRF	(37,403)
VNPF	(36,350)
I CORPS TOTAL	77 BNs 311,212

SLF 7TH FLEET	USMC	USN
BRAVO: BLT 2/9	1,847	60
HMM-165 ENR SUBIC BAY ETA: 22FEB70		
ALFA: BLT 1/9	1,868	85
HMM-164 AT OKINAWA		

MOVEMENTS
 Det 12th Mar and "D" Co, 3d Recon Bn. At Fuji for training.
 VMA-211 w/12 A-4E A/C commenced redeployment. ETA IWAKUNI 18FEB70.

JAPAN	USMC	USN
OSD PROGRAM VIII CEILING	3,600	45
ACTUALS CHARGED AGAINST PROGRAM VIII AS OF 5FEB70	3,749	34
1ST MAF (REAR)		
MAG-15	(2,553)	(34)
VMFA-232 (F-4J)		
VMFA-334 (F-4J)		
VMA(AW)-533 (A-6A)		
VMA-211 (A-4E) (Less command)		
*Does NOT include 243 hospitalized SVN-Originated Patients.		
Non FMF	(1,196)	

* Includes only U. S. Navy Personnel organic to FMF Units.
 # Includes SUM#1 and 1st ANGLICO at various locations throughout SVN.
 • Latest Change

Unclassified

UNCLASSIFIED

MARINE CORPS

FEB 19 1970

REFERENCE BRANCH

Unclassified

UNCLASSIFIED

SUMMARY OF MAJOR US AND FWMAF OPERATIONS

OPERATION (DATE COMMENCED)	UNITS INVOLVED	LOCATION	CASUALTIES AS OF 192400H FEB70		
			FRIENDLY		ENEMY
			KIA	WIA	KIA
GREENE RIVER (19JAN70)	1ST BDE, 5TH INF DIV (MECH): 4 USA BNS	EASTERN QUANG TRI PROVINCE	4	114	61
RANDOLPH GLEN (7DEC69)	101ST ABN DIV (AM): 9 USA BNS	QUANG TRI & THUA THIEN PROVINCES	62	274	429
VICTORY DRAGON XIX (1JAN70)	2D ROKMC BDE: 4 ROKMC BNS	HOI AN AREA	1	12	18
FREDERICK HILL (18MAR69)	196TH INF BDE: 3 USA BNS	QUANG TIN PROVINCE	370	2,343	4,519
GENEVA PARK (18JUL69)	198TH INF BDE: 2 USA BNS	QUANG TIN & QUANG NGAI PROVINCES	127	860	1,186
NANTUCKET BEACH (20JUL69)	198TH INF BDE: 1 USA BN	CENTERED 15 KM NE OF QUANG NGAI CITY	24	220	250
IRON MOUNTAIN (18MAR69)	11TH INF BDE: 5 USA BNS	QUANG NGAI PROVINCE	288	1,672	2,503

* - ADJUSTED
- FINAL CUMULATIVE CASUALTIES

UNCLASSIFIED

Unclassified

UNCLASSIFIED

MARINE CORPS COMMAND CENTER

USMC/ENEMY CASUALTIES IN RVN

19 FEBRUARY 1970

USMC BATTLE CASUALTIES

KIA/DOW	WIA(EVAC)	WIA(RTD)	MIA/PW
12,476	48,905	35,840	81/21

USMC CASUALTY FIGURES ARE PROVIDED DAILY BY HQMC CASUALTY SECTION (CODE DNA) AND REFLECT ALL CASUALTIES REPORTED AS OF 18FEB70.

USMC NON-BATTLE CASUALTIES

DEAD	INJURED	MISSING
1,512	1,822	13

FIGURES INDICATED AS INJURED ARE ONLY THOSE IN SERIOUS/CRITICAL INJURY OR DISEASE CATEGORY AND DO NOT INCLUDE THOSE OF A MINOR NATURE

USMC INFLECTED ENEMY CASUALTIES

KIA	PW	WPNS
80,668	4,200	29,813

ENEMY CASUALTIES ARE COMPILED DAILY FROM THE III MAF HISSUM AND ARE RECONCILED MONTHLY WITH THE FMFPAC SUMMARY OF USMC OPERATIONS IN RVN.

TYPICAL DISPOSITION OF 100 USMC WIA *

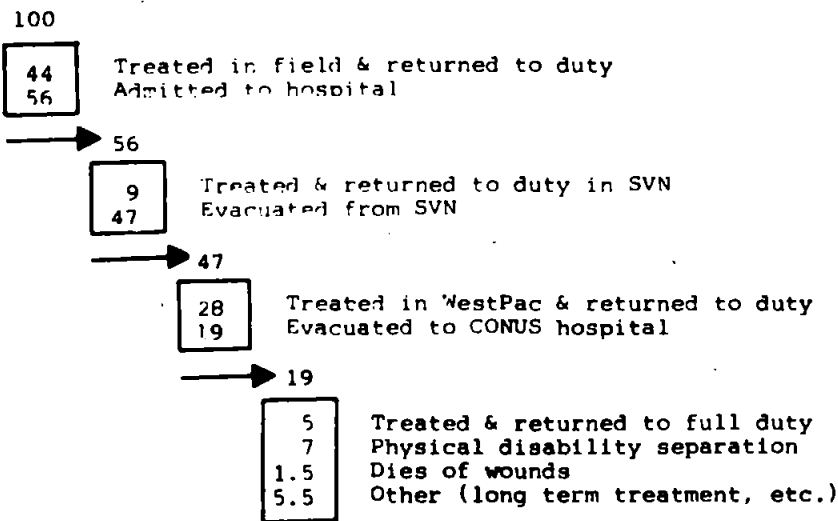

*54,081 CASUALTIES, JAN67-DEC68.

UNCLASSIFIED

Unclassified

19 FEBRUARY 1970

MARINE CORPS COMMAND CENTER

MILITARY FORCES IN RVN *

~~CONFIDENTIAL~~
UNCLASSIFIED

RVN ARMED FORCES (RVNAF)

ARMY (ARVN)	416,278
NAVY (VNN)	30,143
AIR FORCE (VNAF)	36,469
MARINE CORPS (VNUMC)	11,528
REGIONAL FORCES (RF)	260,455
POPULAR FORCES (PF)	214,383
TOTAL RVNAF	969,256

UNITED STATES FORCES

ARMY	333,615
NAVY	29,128
AIR FORCE	56,553
MARINE CORPS	52,480
COAST GUARD	369
TOTAL U.S.	472,145

FREE WORLD MILITARY ASSISTANCE FORCES (FWMAF)

REPUBLIC OF KOREA	48,871
AUSTRALIA	7,696
PHILIPPINES	142
THAILAND	11,568
NEW ZEALAND	557
REPUBLIC OF CHINA	28
SPAIN	11
TOTAL FWMAF	68,873

TOTAL FORCES IN RVN 1,510,274

SOURCE: RVNAF MACV MONTHLY STRENGTH REPORT. ALL OTHER:
MACV WEEKLY STRENGTH REPORT AS OF 2400, 12FEB70.
USMC STRENGTH: MACV WEEKLY STRENGTH REPORT AS
ADJUSTED BY MACV RPT OF ARR/DEP AS OF 2400, 17FEB70.

UNCLASSIFIED
Unclassified
~~CONFIDENTIAL~~

UNCLASSIFIED

LANDING FORCE, SIXTH FLEET 3-69

19 FEBRUARY 1970

UNITS EMBARKED	STRENGTH				ARMS & EQUIPMENT	LOCATION
	USMC		USN			
	OFF	ENL	OFF	ENL		
TF-61/62 CTG: LTCOL G. B. CRIST					31 7.62 MG 10 LVTP-5 6 105 HOW 5 90MM GUN TANK 5 ONTOS 8 81MM MORTARS 8 FLAME THROWERS 6 106MM RR	ENR ATHENS ETA: 210600Z FEB70.
BLT 2/6 (LTCOL G. B. CRIST)						SHIPPING USS CAMBRIA (APA-36) USS LASALLE (LPD-3) USS RUSHMORE (LSD-14) USS WAHKIATUM (LST-1162)
2D BN, 6TH MAR	49	1030	4	33		
DET HOCO, 6TH MAR						SUPPLIES CLASS I CLASS II CLASS III CLASS IV CLASS V
BTRY "E", 2/10	9	124				
DET HQ BTRY, 2/10	2	10		2		
PLT CO "C", 2D AMTRAC BN	1	45				
PLT CO "B", 8TH MT BN		19				
PLT CO "C", 2D AT BN	1	21				
PLT CO "B", 2D ENGR BN		49				
PLT CO "A", 2D MED BN		10	1	9		
PLT CO "A", 2D TK BN	1	24				
PLT CO "A", 2D SP BN	1	49				
PLT CO "B", 2D RECON BN	1	24		1		
DET HQBN, 2D MARDIV		27				
DET 2D DENTAL CO			2	2		
DET 2D SERVICE BN	1	42				
DET 2D FSR		40				
TOTALS	66	1514	7	47		

LANDING FORCE, CARIBBEAN 1-70

16 FEBRUARY 1970

UNITS EMBARKED	STRENGTH				ARMS & EQUIPMENT	LOCATION
	USMC		USN			
	OFF	ENL	OFF	ENL		
TASK GROUP 45.9 CTG: COL G. R. HUNTER					11 LVTP-5 5 M48 TANK 5 M50 ONTOS 6 105MM HOW TD 8 106MM RR 8 81MM MORTAR	ENR LIBERTY PORTS. ETA 20FEB70.
HQ 36TH MEU BLT 3/2 (LTCOL E. F. PIERSON JR.)						SHIPPING USS GUADALCANAL (LPH-7) USS VERMILION (LKA-107) USS SUFFOLK CTY (LST-1173) USS SPEIGEL GROVE (LSD-32)
3D BN, 2D MARINES	44	1007	4	38		
BTRY "I", 3/10	10	136	1	2		SUPPLIES CLASS I CLASS II CLASS III CLASS IV CLASS V
DET HQ BTRY, 3/10						
PLT CO "B", 2D AMTRAC BN	1	40				
PLT CO "C", 2D MT BN	1	33				
PLT CO "A", 2D AT BN	1	21				
PLT CO "A", 2D ENGR BN	1	49				
PLT H&S CO, 2D MED BN		10		17		
PLT CO "A", 2D TANK BN	1	24				
PLT CO "A", 2D SP BN	1	52		7		
PLT CO "C", 2D RECON BN	1	23		1		
DET HQBN, 2D MARDIV	1	25				
DET 2D DENTAL CO			1	1		
DET 2D SERV BN	1	40				
DET 2D FSR	1	37				
DET HOCO 2D MARINES		20				
HMM-261 (LTCOL V. M. HAZELBAKER)	43	170	1			
TOTALS	107	1687	7	61		

42-1

UNCLASSIFIED

Unclassified

~~CONFIDENTIAL~~
UNCLASSIFIED

MARINE CORPS COMMAND CENTER

SELECTED PERSONNEL AND AIRCRAFT DATA

PERSONNEL

20 FEBRUARY 1970

		STRENGTH	PERCENT USMC	PERCENT FMF	PERCENT FMFPAC
USMC TOTAL		300,982 *	100.00		
FLEET MARINE FORCES		153,295	50.93	100.00	
	FMF ATLANTIC	45,696 \$	15.18	29.81	
	FMF PACIFIC	107,599 #	35.75	70.19	
	VIETNAM	52,444 ¢	17.42	34.21	48.74

SOURCE: * MONTHLY USMC PERSONNEL ALLOCATION REPORT OF 30NOV69.
\$ MCCC UNIT REPORT OF 12FEB70.
MCCC UNIT REPORT OF 4FEB70.
¢ MACV WEEKLY STRENGTH REPORT AS OF 2400, 12FEB70 AS ADJUSTED BY THE MACV DAILY RPT OF ARR/DEP AS OF 2400, 18FEB70.

AIRCRAFT

5 FEBRUARY 1970

		FIXW	HELO	TOTAL	PERCENT USMC	PERCENT FMF	PERCENT FMFPAC
USMC TOTALS		1013	569	1582	100.00		
FLEET MARINE FORCES		763	543	1306	82.55	100.00	
	FMF ATLANTIC	303	156	459	29.01	35.15	
	FMF PACIFIC	460	387	847	53.54	64.85	
	VIETNAM	156	178	334	21.11	25.57	39.43

SOURCE: MARINE CORPS COMMAND CENTER UNIT REPORT OF 31DEC69.

UNCLASSIFIED

Unclassified

~~CONFIDENTIAL~~

CONFIDENTIAL
UNCLASSIFIED

FLEET MARINE FORCE DEPLOYMENTS

20 FEBRUARY 1970



1ST MAR BRIG
HAWAII

10TH MARINES
DET, 2D FAG
DET 1, HMM-264
AT VIEQUES FOR FIREX,
ETD 25MAR70 FOR
CAMLEJ.

GTMO AUGMENT

2D BN, 8TH MAR
BTRY B/1/10
PLT, 2D TK BN
PLT, 2D ANGLICO
DET, FSR

LANFORCARIB 1-70

BLT 3/2 & HMM-261
AT LIBERTY PORTS

LANFOR6THFLT 3-69

ENR ATHENS
ETA: 210600Z FEB70

III MAF

RVN

SLF, 7TH FLEET

SLF ALFA

AT OKINAWA

SLF BRAVO

ENR SUBIC BAY
ETA: 22FEB70

I MEF

OKINAWA
& JAPAN

DET, 12THMAR "D" CO,
3D RECON BN AT FUJI
FOR TRNG.

DISTRIBUTION OF MAJOR FMF UNITS

	INF BNS	VMFA	VMA	VMA(AW)	VMCI	BMM	BMH	HML	VMO	VMGR
WESTPAC	18	5	2	3	1	6	2	2	2	1
RVN	(12)	(3)	(1)	(2)	(1)	(4)	(1)	(2)	(2)	
OKINAWA/JAPAN	(4)	(2)	(1)*	(1)			(1)		(1)	(1)
ASSIGNED TO SLF'S	(2)					(2)				
MIDPAC	1	2								
HAWAII AFLOAT	(1)	(2)								
EASTPAC	2	**3	2		1	2	2	1		1
WEST COAST AFLOAT	(2)	(3)	(2)		(1)	(2)	(2)	(1)		(1)
ATLANTIC	8	5	2	3	1	4	2		1	1
EAST COAST	(6)	(5)	(2)	(3)	(1)	(3)	(2)		(1)	(1)
CARIBBEAN	(2)					(1)				
EUROPE	1									
MEDITERRANEAN	(1)									
GRAND TOTAL	30	15	6	6	3	12	6	3	3	3

* ENROUTE IWAKUNI.
** VMFA-323 IN CADRE STATUS.

UNCLASSIFIED

~~SECRET~~

UNCLASSIFIED

MARINE CORPS COMMAND CENTER

MARINE CORPS PERSONNEL IN RVN

20 FEBRUARY 1970

	OFF	ENL	TOTAL
* III MAF.	3,485	48,651	52,136
DANANG	(2,986)	(42,256)	(45,242)
CHU LAI	(391)	(4,824)	(5,215)
PHU BAI	(73)	(868)	(941)
DONG HA	(35)	(703)	(738)
SU #1, 1ST ANGLICO (AT VARIOUS LOCATIONS SVN)	((21))	((191))	((212))
OTHER USMC PERSONNEL	159	149	308
MACV STAFF/MACV FIELD	(136)	(136)	(272)
NAVADVGRU/NAVY UNITS	(23)	(13)	(36)
USMC IN RVN CHARGED AGAINST PROGRAM VIII	3,644	48,800	52,444
U. S. NAVY, III MAF.	256	1,784	2,040

* AS REPORTED BY III MAF DAILY ADMIN SITREP # 42 AS OF 2400, 10FEB70 AND THE MACV WEEKLY STRENGTH REPORT, AS OF 2400, 12FEB70 AS ADJUSTED BY MACV DAILY RPT OF ARR/DEP AS OF 2400, 18FEB70

Unclassified

UNCLASSIFIED

~~SECRET~~

JESTPAC UNIT LOCATIONS

20 FEBRUARY 1970

QUANG TRI (QUANG TRI)

USMC 738
USN 37
USA 5,826

- 1ST BDE, 5TH INF DIV (MECH)
- 1/77 ARMOR (OPN GREENE RIVER)
- 1/61 INF (MECH) (OPN GREENE RIVER)
- 1/11 INF (OPN GREENE RIVER)
- 3/5 ARMD CAV SQDN (OPN GREENE RIVER)

USMC RVN RECAP

	USMC	USN
OSD PROGRAM VIII CEILING	55,510	2,233
ACTUALS CHARGED AGAINST PROGRAM VIII AS OF 18FEB70	52,444	2,040
III MAP	52,136	2,040
SU#1 1ST ANGLICO	(212)	(14)
OTHER	308	
MACV STAFF/MACV FIELD	(272)	
NAVAIDVGRU/NAVY UNITS	(36)	

THUA THIEN

HO, XXIV CORPS (PHU BAI)

HO, 101st ABN DIV (AM)

USMC 941
USN 46
USA 26,259

- 1ST BDE, 101ST ABN DIV (AM)
 - 1/327 INF (AM) (OPN RANDOLPH GLEN)
 - 2/327 INF (AM) (OPN RANDOLPH GLEN)
 - 2/502 INF (AM) (OPN RANDOLPH GLEN)
- 2D BDE, 101ST ABN DIV (AM)
 - 1/501 INF (AM) (OPN RANDOLPH GLEN)
 - 2/501 INF (AM) (OPN RANDOLPH GLEN)
 - 1/502 INF (AM) (OPN RANDOLPH GLEN)
- 3D BDE, 101ST ABN DIV (AM)
 - 1/506 INF (AM) (OPN RANDOLPH GLEN)
 - 2/506 INF (AM) (OPN RANDOLPH GLEN)
 - 3/187 INF (AM) (OPN RANDOLPH GLEN)

I CORPS RECAP

US MARINE CORPS	(12 BNs)	52,136
US ARMY	(25 BNs)	73,849
US NAVY		16,954
US AIR FORCE		8,194
ROKMC	(4 BNs)	6,148
RVNAF	(36 BNs)	153,895
ARVN/ABN	(36 BNs)	(74,634)
VNMC		
VNN		(2,100)
VNAF		(3,408)
VNRF		(37,403)
VNPF		(36,350)
I CORPS TOTAL	77 BNs	311,176

QUANG NAM

HOS 1ST MAR DIV (DANANG)

HOS, III MAF

USMC 45,242
USN 1,841
USA 1,110
ROKMC 7,145

1ST MARINES

- 1/1
- 2/1
- 3/1

HO 1st MAW
MAG-11

5TH MARINES

- 1/5
- 2/5
- 3/5

VMA(AW)-242 (A-6A)
VMA(AW)-225 (A-6A)
VMCJ-1 (RF-4/EA-6/EF-10)
VMO-2 (OV-10A)

7TH MARINES

- 1/7
- 2/7
- 3/7

MAG-16
HML-367 (AH-1G)
HML-167 (UH-1E)
HMH-463 (CH-53A)
HMM-364 (CH-46D)
HMM-263 (CH-46D)
HMM-262 (CH-46D)
HMM-161 (CH-46D)

26TH MARINES

- 1/26
- 2/26
- 3/26

2d ROKMC BDE

- 1/2 (OPN VICTORY DRAGON XIX)
- 2/2 (OPN VICTORY DRAGON XIX)
- 3/2 (OPN VICTORY DRAGON XIX)
- 5/2 (OPN VICTORY DRAGON XIX)

FLC 1ST FSR/FLSG-B/1ST SERV BN

QUANG TIN/QUANG NGAI

HO 23d INF DIV (AMERICAN) (CHU LAI)

1st MAW

USMC 5,215
USN 116
USA 24,391

196TH LT INF BDE

- 2/1 INF (OPN FREDERICK HILL)
- 4/31 INF (OPN FREDERICK HILL)
- 3/21 INF (OPN FREDERICK HILL)
- 1/46 INF

MAG-12

198TH LT INF BDE

- 1/6 INF (OPN GENEVA PARK)
- 1/52 INF (OPN GENEVA PARK)
- 5/46 INF (OPN NANTUCKET BEACH)

MAG-13

11TH INF BDE

- 1/20 INF (OPN IRON MOUNTAIN)
- 4/21 INF (OPN IRON MOUNTAIN)
- 3/1 INF (OPN IRON MOUNTAIN)
- 4/3 INF (OPN IRON MOUNTAIN)
- 1/1 ARMD CAV SQDN (OPN IRON MOUNTAIN)

VMFA-115 (F-4B)
VMFA-314 (F-4B)
VMFA-122 (F-4B)
VMA-311 (A-4E)

OKINAWA

HO, I MEF
3D MARDIV (-)(REIN)(TF-79)
11th MEB (TF-79.1)

OSD PROGRAM VIII CEILING 19,200 934
ACTUALS CHARGED AGAINST PROGRAM VIII AS OF 5FEB70 18,580 424

- 4TH MARINES
- 1/4
 - 2/4
 - 3/4

9TH MARINES

MAG-36

VMGR-152 (KC-130F)
VMO-6 (OV-10A/UH-1E)
HMH-462 (CH-53A)

3D FSR (3,456) (50)
MCB CAMP BUTLER/NON FMF (915) (25)
Non-Deployable Casuals (148)
SVN-Originated Patients (0)

JAPAN

	USMC	USN
OSD PROGRAM VIII CEILING	3,600	45
ACTUALS CHARGED AGAINST PROGRAM VIII AS OF 5FEB70	3,749	34

1ST MAW (REAR)

MAG-15 (2,553) (34)
VMFA-232 (F-4J)
VMFA-334 (F-4J)
VMA(AW)-533 (A-6A)
VMA-211 (A-4E)
(Less command)

*Does NOT include 243 hospitalized SVN-Originated Patients.

Non FMF (1,196)

* Includes only U. S. Navy Personnel organic to FMF Units.
Includes SU#1 and 1st ANGLICO at various locations throughout SVN.
• Latest Change

Unclassified

UNCLASSIFIED

UNCLASSIFIED

SUMMARY OF MAJOR RVNAF OPERATIONS

OPERATION (DATE COMMENCED)	UNITS INVOLVED	LOCATION	CASUALTIES AS OF : 202400H FEB70		
			FRIENDLY		ENEMY
			KIA	WIA	KIA
LAM SON 350 (1JAN70)	2ND REGT: 1/2, 2/2, 3/2, 4/2 & 5/2	5 KM E OF GIO LINH	17	23	172
LAM SON 353 (1JAN70)	7TH CAV: 3/7 CAV	5 KM SE OF GIO LINH	4	19	28
LAM SON 354 (6JAN70)	54TH REGT: 3/54	6 KM S OF QUANG TRU CITY	1	3	1
LAM SON 352 (1JAN70)	54TH REGT: 1/54, 2/54 & 4/54	2 KM NW OF PHU BAI	1	6	29
LAM SON 349 (1JAN70)	1ST REGT: 1/1, 2/1, 3/1 & 4/1	21 KM NW OF A LUOI	11	36	144
LAM SON 351 (1JAN70)	3RD REGT: 1/3, 2/3, 3/3 & 4/3	25 KM SW OF HUE	5	10	45
HUNG QUANG 1/22 (12JAN70)	51ST REGT: 2/51 & 4/51	16 KM NW OF HOI AN	1	17	3
HUNG QUANG 1/25 (19FEB70)	51ST REGT: 1/51 & 3/51	5 KM NNW OF AN HOA	1	1	NONE
QUYET THANG 54 (2JAN70)	5TH REGT: 1/5, 2/5, 4/5 & 4/6	12 KM W OF TAM KY	18	65	183
DUONG SON 3/70 (11FEB70)	1ST ARM BDE: 37TH & 39TH RCR BNS & 2/17 & 3/17 ACAT	30 KM NW OF TAM KY	32	82	316
QUYET THANG 63 (2JAN70)	6TH REGT: 1/6 & 3/6	18 KM NW OF QUANG NGAI CITY	21	90	137
QUYET THANG 45 (4JAN70)	4TH REGT: 1/4, 2/4, 3/4 & 4/4	11 KM SW OF DUC PHO	19	53	290
PHU DONG 401 (11FEB70) (TERM: 201000H)	2D BN 6TH REGT: 2/6, 1/4 & 2/4 ACAT	12 KM SW OF QUANG NGAI CITY	#NONE	#NONE	#NONE

ALL UNITS ARE ARVN UNLESS DESIGNATED
 * - ADJUSTED
 # - FINAL CUMULATIVE CASUALTIES

~~SECRET~~
UNCLASSIFIED

Unclassified

UNCLASSIFIED

SUMMARY OF MAJOR US AND FWMAF OPERATIONS

OPERATION (DATE COMMENCED)	UNITS INVOLVED	LOCATION	CASUALTIES AS OF 202400H FEB70		
			FRIENDLY		ENEMY
			KIA	WIA	KIA
GREENE RIVER (19JAN70)	1ST BDE, 5TH INF DIV (MECH); 4 USA BNS	EASTERN QUANG TRI PROVINCE	4	114	61
RANDOLPH GLEN (7DEC69)	101ST ABN DIV (AM); 9 USA BNS	QUANG TRI & THUA THIEN PROVINCES	62	274	429
VICTORY DRAGON XIX (1JAN70)	2D ROKMC BDE; 4 ROKMC BNS	HOI AN AREA	1	12	18
FREDERICK HILL (18MAR69)	196TH INF BDE: 3 USA BNS	QUANG TIN PROVINCE	372	2,356	4,526
GENEVA PARK (18JUL69)	198TH INF BDE: 2 USA BNS	QUANG TIN & QUANG NGAI PROVINCES	127	861	1,191
NANTUCKET BEACH (20JUL69)	198TH INF BDE: 1 USA BN	CENTERED 15 KM NE OF QUANG NGAI CITY	24	222	250
IRON MOUNTAIN (18MAR69)	11TH INF BDE: 5 USA BNS	QUANG NGAI PROVINCE	288	1,673	2,536

* - ADJUSTED
- FINAL CUMULATIVE CASUALTIES

UNCLASSIFIED

UNCLASSIFIED

MARINE CORPS COMMAND CENTER

USMC/ENEMY CASUALTIES IN RVN

20 FEBRUARY 1970

USMC BATTLE CASUALTIES

KIA/DOW	WIA(EVAC)	WIA(RTD)	MIA/PW
12,477	48,918	35,852	81/21

USMC CASUALTY FIGURES ARE PROVIDED DAILY BY HQMC CASUALTY SECTION (CODE DNA) AND REFLECT ALL CASUALTIES REPORTED AS OF

USMC NON-BATTLE CASUALTIES

DEAD	INJURED	MISSING
1,514	1,822	13

FIGURES INDICATED AS INJURED ARE ONLY THOSE IN SERIOUS/CRITICAL INJURY OR DISEASE CATEGORY AND DO NOT INCLUDE THOSE OF A MINOR NATURE

USMC INFLECTED ENEMY CASUALTIES

KIA	PW	WPNS
80,711	4,200	20,814

ENEMY CASUALTIES ARE COMPILED DAILY FROM THE III MAF HISSUM AND ARE RECONCILED MONTHLY WITH THE FMFPAC SUMMARY OF USMC OPERATIONS IN RVN

TYPICAL DISPOSITION OF 100 USMC WIA *

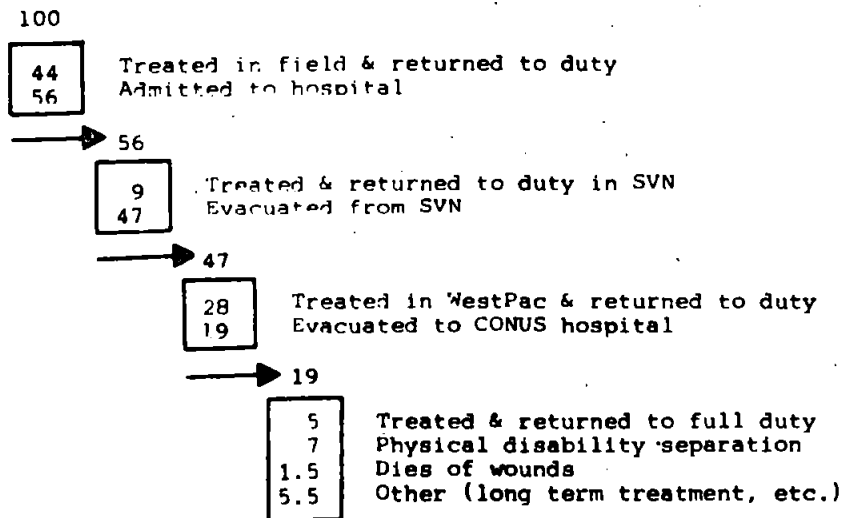

*54,081 CASUALTIES, JAN67-DEC68.

Unclassified

UNCLASSIFIED

20 Feb 70

MARINE CORPS COMMAND CENTER

~~CONFIDENTIAL~~

UNCLASSIFIED

MILITARY FORCES IN RVN *

RVN ARMED FORCES (RVNAF)

ARMY (ARVN)	416,278
NAVY (VNN)	30,143
AIR FORCE (VNAF)	36,469
MARINE CORPS (VNMC)	11,528
REGIONAL FORCES (RF)	260,455
POPULAR FORCES (PF)	214,383
TOTAL RVNAF	969,256

UNITED STATES FORCES

ARMY	333,615
NAVY	29,128
AIR FORCE	56,553
MARINE CORPS	52,444
COAST GUARD	369
TOTAL U.S.	472,109

FREE WORLD MILITARY ASSISTANCE FORCES (FWMAF)

REPUBLIC OF KOREA	48,871
AUSTRALIA	7,696
PHILIPPINES	142
THAILAND	11,568
NEW ZEALAND	557
REPUBLIC OF CHINA	28
SPAIN	11
TOTAL FWMAF	68,873

TOTAL FORCES IN RVN 1,510,238

SOURCE: RVNAF MACV MONTHLY STRENGTH REPORT. ALL OTHER:
MACV WEEKLY STRENGTH REPORT AS OF 2400, 12FEB70.
USMC STRENGTH: MACV WEEKLY STRENGTH REPORT AS
ADJUSTED BY MACV RPT OF ARR/DEP AS OF 2400, 18FEB70.

UNCLASSIFIED

Unclassified

UNCLASSIFIED

LANDING FORCE, SIXTH FLEET 3-69

19 FEBRUARY 1970

UNITS EMBARKED	STRENGTH				ARMS & EQUIPMENT	LOCATION
	USMC		USN			
	OFF	ENL	OFF	ENL		
TF-61/62 CTG: LTCOL G. B. CRIST					31 7.62 MG 10 LVTP-5 6 105 HOW 5 90MM GUN TANK 5 ONTOS 8 81MM MORTARS 8 FLAME THROWERS 6 106MM RR 21 MULES 32 MITES 22 2 1/2 TON TRUCKS 8 JEEPS 3 5 TON CARGO TRUCKS 9 3/4 TON UTIL TRUCKS 4 AMBULANCES 4 CRANES AIRCRAFT NO AIRCRAFT	ENR ATHENS ETA: 210600Z FEB70
BLT 2/6 (LTCOL G. B. CRIST)						
2D BN, 6TH MAR	49	1030	4	33		SHIPPING USS CAMBRIA (APA-36) USS LASALLE (LPD-3) USS RUSHMORE (LSD-14) USS WAHIAKUM (LST-1162)
DET HQCO, 6TH MAR						
BTRY "E", 2/10	9	124				
DET HQ BTRY, 2/10	2	10		2		
PLT CO "C", 2D AMTRAC BN	1	45				
PLT CO "B", 8TH MT BN		19				
PLT CO "C", 2D AT BN	1	21				
PLT CO "B", 2D ENGR BN		49				
PLT CO "A", 2D MED BN		10	1	9		
PLT CO "A", 2D TK BN	1	24				
PLT CO "A", 2D SP BN	1	49				
PLT CO "B", 2D RECON BN	1	24		1		
DET HQBN, 2D MARDIV		27				
DET 2D DENTAL CO			2	2		
DET 2D SERVICE BN	1	42				
DET 2D FSR		40				
TOTALS	66	1514	7	47		SUPPLIES CLASS I CLASS II CLASS III CLASS IV CLASS V

LANDING FORCE, CARIBBEAN 1-70

20 FEBRUARY 1970

UNITS EMBARKED	STRENGTH				ARMS & EQUIPMENT	LOCATION
	USMC		USN			
	OFF	ENL	OFF	ENL		
TASK GROUP 45.9 CTG: COL G. R. HUNTER					11 LVTP-5 5 M48 TANK 5 M50 ONTOS 6 105MM HOW TD 8 106MM RR 8 81MM MORTAR AIRCRAFT 19 CH-46D	AT LIBERTY PORTS
HQ 36TH MEU BLT 3/2 (LTCOL E. F. PIERSON JR.)						
3D BN, 2D MARINES	44	1007	4	38		SHIPPING USS GUADALCANAL (LPH-7) USS VERMILLION (LKA-107) USS SUFFOLK CTY (LST-1173) USS SPEIGEL GROVE (LSD-32)
BTRY "I", 3/10	10	136	1	2		
DET HQ BTRY, 3/10						
PLT CO "B", 2D AMTRAC BN	1	40				
PLT CO "C", 2D MT BN	1	33				
PLT CO "A", 2D AT BN	1	21				
PLT CO "A", 2D ENGR BN	1	49				
PLT H&S CO, 2D MED BN		10		17		
PLT CO "A", 2D TANK BN	1	24				
PLT CO "A", 2D SP BN	1	52		7		
PLT CO "C", 2D RECON BN	1	23		1		
DET HQBN, 2D MARDIV	1	25				
DET 2D DENTAL CO			1	1		
DET 2D SERV BN	1	40				
DET 2D FSR	1	37				
DET HQCO 2D MARINES		20				
HMM-261 (LTCOL V. M. HAZELBAKER)	43	170	1			SUPPLIES CLASS I CLASS II CLASS III CLASS IV CLASS V
TOTALS	107	1687	7	61		

UNCLASSIFIED

Unclassified

~~CONFIDENTIAL~~

UNCLASSIFIED

MARINE CORPS COMMAND CENTER

SELECTED PERSONNEL AND AIRCRAFT DATA

PERSONNEL

21 FEBRUARY 1970

	STRENGTH	PERCENT USMC	PERCENT FMF	PERCENT FMFPAC
USMC TOTAL	300,982 *	100.00		
FLEET MARINE FORCES	153,295	50.93	100.00	
FMF ATLANTIC	45,696 \$	15.18	29.81	
FMF PACIFIC	107,599 #	35.75	70.19	
VIETNAM	52,393 ¢	17.42	34.21	48.74

SOURCE: * MONTHLY USMC PERSONNEL ALLOCATION REPORT OF 30NOV69.
 \$ MCCC UNIT REPORT OF 12FEB70.
 # MCCC UNIT REPORT OF 4FEB70.
 ¢ MACV WEEKLY STRENGTH REPORT AS OF 2400, 12FEB70 AS ADJUSTED BY THE MACV DAILY RPT OF ARR/DEP AS OF 2400, 19FEB70.

AIRCRAFT

5 FEBRUARY 1970

	FIXW	HELO	TOTAL	PERCENT USMC	PERCENT FMF	PERCENT FMFPAC
USMC TOTALS	1013	569	1582	100.00		
FLEET MARINE FORCES	763	543	1306	82.55	100.00	
FMF ATLANTIC	303	156	459	29.01	35.15	
FMF PACIFIC	460	387	847	53.54	64.85	
VIETNAM	156	178	334	21.11	25.57	39.43

SOURCE: MARINE CORPS COMMAND CENTER UNIT REPORT OF 31DEC69.

UNCLASSIFIED
Unclassified

~~CONFIDENTIAL~~

UNCLASSIFIED

FLEET MARINE FORCE DEPLOYMENTS

21 FEBRUARY 1970



1ST MAR BRIG
HAWAII

10TH MARINES
DET, 2D FAG
DET 1, HMM-264
AT VIEQUES FOR FIREX.
ETD 25MAR70 FOR
CAMLEJ.

GTMO ARGUMENT
2D BN, 8TH MAF
STRY B/1/1
PLT, 2D TK BN
PLT, 2D ANGLICO
DET, FSR

LANFORCARIB 1-70
JLT 3/2 & HMM-261
AT LIBERTY PORTS

LANFOR6THFLT 3-69
AT ATHENS

III MAF
RVN

SLF, 7TH FLEET
SLF ALFA
AT OKINAWA
SLF BRAVO
AT SUBIC

I MEF

OKINAWA
& JAPAN

DET, 12THMAR: "D" CO,
3D RECON BN AT FUJI
FOR TRNG.

DISTRIBUTION OF MAJOR FMF UNITS

	INF REG	VMFA	VMA	VMC(AW)	VMC	BMN	HMH	HML	VMO	VMGR
WESTPAC	10	7	2	1	1	6	2	2	2	1
RVN	(12)	(1)	(1)	(1)	(1)	(4)	(1)	(2)	(2)	
OKINAWA/JAPAN	(4)	(2)	(1)	(1)			(1)		(1)	(1)
ASSIGNED TO SLF'S	(3)					(2)				
MIDPAC	1									
HAWAII AFLOAT	(1)	(2)								
EASTPAC	2	**3	2		1	2	2	1		1
WEST COAST AFLOAT	(2)	(3)	(2)		(1)	(2)	(2)	(1)		(1)
ATLANTIC	8	5	2	3	1	4	2		1	1
EAST COAST CARIBBEAN	(6) (2)	(5)	(2)	(3)	(1)	(3) (1)	(2)		(1)	(1)
EUROPE	1									
MEDITERRANEAN	(1)									
GRAND TOTAL	30	15	6	6	3	12	6	3	3	3

* ENROUTE IWAKUNI
** VMFA-323 IN CONDUCT OF...

UNCLASSIFIED
Unclassified

MARINE CORPS COMMAND CENTER

UNCLASSIFIED SELECTED UNIT COMMANDERS AND STAFF OFFICERS

21 FEBRUARY 1970

HEADQUARTERS III MARINE AMPHIBIOUS FORCE

COMMANDING GENERAL	LTGEN H. NICKERSON, JR.
DEPUTY COMMANDER	MGEN G. S. BOWMAN, JR.
CHIEF OF STAFF	BGEN L. J. DULACKI
DEPUTY CHIEF OF STAFF	COL S. A. DRESSIN
ACOS, G-1	COL R. L. PARNELL, JR.
ACOS, G-2	COL E. W. DZIALO
ACOS, G-3	BGEN T. H. MILLER, JR.
ACOS, G-4	COL W. F. SIMLIK
ACOS, G-5	COL C. J. PEABODY
ACOS, G-6	LTCOL R. S. BARRY
ACOS, COMPT	LTCOL J. M. VOSMIK
DEP C/S SPECIAL PROJECTS	COL A. T. WOOD

CG XXIV CTZ	LTGEN M. ZAIS USA
DEP C/S XXIV CTZ	COL M. M. COOK USMC

ACOS, CAP	COL T. E. METZGER
COMMANDING OFFICER, 1ST CAG	LTCOL D. F. SEILER
COMMANDING OFFICER, 2ND CAG	LTCOL D. R. CHRISTENSEN
COMMANDING OFFICER, 3RD CAG	LTCOL C. M. DANIELS
COMMANDING OFFICER, 4TH CAG	LTCOL J. J. KEENAN
1ST RADIO BATTALION	LTCOL D. M. HOPKINS

1ST MARINE DIVISION

COMMANDING GENERAL	MGEN E. B. WHEELER
AIDC	BGEN W. F. DDEHLER
CHIEF OF STAFF	COL C. E. WALKER
ACOS, G-1	COL R. E. BARDE
ACOS, G-2	COL S. A. WILCOX
ACOS, G-3	COL F. H. WALDROP
ACOS, G-4	COL N. A. CANZONA
ACOS, G-5	COL L. S. HULLIER
ACOS, COMPT	LTCOL H. M. LASLAVIC, JR.
CEO	COL C. G. DAHL

1ST MARINES	
COMMANDING OFFICER	COL E. A. WILCOX
1ST BATTALION	LTCOL G. S. DELCUZE
2ND BATTALION	LTCOL W. V. H. WHITE
3RD BATTALION	LTCOL F. M. BOYD

5TH MARINES	
COMMANDING OFFICER	COL R. F. ESTEV
1ST BATTALION	LTCOL J. K. GRIFFIS, JR.
2ND BATTALION	LTCOL F. LEDER
3RD BATTALION	LTCOL J. S. GESTSON

7TH MARINES	
COMMANDING OFFICER	COL G. S. CODISPOFF
1ST MARINES	LTCOL C. G. COOPER
2ND MARINES	LTCOL A. E. FOLSCM
3RD MARINES	LTCOL R. C. KUMMERW

26TH MARINES	
COMMANDING OFFICER	COL J. E. HANFELL
1ST BATTALION	LTCOL J. C. GOODWIN
2ND BATTALION	LTCOL P. L. HUMPHREY
3RD BATTALION	LTCOL J. J. UNTERKOFFLER

11TH MARINES	
COMMANDING OFFICER	COL D. D. EZELE
1ST BATTALION	LTCOL J. D. SHCUP
2ND BATTALION	LTCOL V. WEAVER
3RD BATTALION	LTCOL K. N. MUELLER
4TH BATTALION	LTCOL J. F. BURKE, JR.

1ST BN, 13TH MAR	LTCOL D. H. STRAIN
HQS BATTALION	COL W. C. PATTON

1ST ENGR BATTALION	LTCOL N. P. GLOWICKI
1ST RECON BATTALION	LTCOL W. C. DRUMFIGHT
1ST MT BATTALION	LTCOL M. S. SHIMANOFF
1ST SP BATTALION	COL R. F. ARMSTRONG
1ST MED BATTALION	CAPT(MC) J. W. LEA
1ST TK BATTALION	MAJOR J. I. LOUDER
3RD AMTRAC BATTALION	LTCOL D. G. MEHARGUE
7TH ENGR BATTALION	LTCOL W. G. BATES
9TH ENGR BATTALION	LTCOL E. K. MAXWELL
11TH MT BATTALION	LTCOL W. R. KEPHART

FORCE LOGISTICS COMMAND

COMMANDING GENERAL	BGEN M. J. PADALINO
CHIEF OF STAFF	COL J. L. TOBIN
ACOF, G-1	LTCOL J. E. REDELFS
ACOS, G-2	LTCOL R. L. SOLZE
ACOS, G-3	LTCOL W. W. STORM, III
ACOS, G-4	LTCOL M. H. IVINS
ACOS, G-5	MAJOR R. E. JOHNSON
ACOS, COMPT	LTCOL F. R. WARREN
CEO	MAJOR R. D. HAGAN

1ST FORCE SERVICE REGT	
HQS BATTALION	LTCOL L. R. WEBB
SUPPLY BATTALION	COL R. W. CALVERT
MAINT BATTALION	LTCOL E. C. MORRIS

FLSG-B/1ST SERV BN	COL D. E. MORIN
5TH COMM BATTALION (REIN)	LTCOL D. E. SHATZER
7TH MT BATTALION	MAJOR L. E. DAVIES
1ST MP BATTALION	LTCOL S. D. THOMASIDIS
3RD MP BATTALION	LTCOL C. FIMIAN

UNCLASSIFIED

FOIA
UNCLASSIFIED UNIT
UNCLASSIFIED

MARINE CORPS COMMAND CENTER

UNSELECTED UNIT COMMANDERS AND STAFF OFFICERS

21 FEBRUARY 1970

1ST MARINE AIRCRAFT WING	3D MARINE AIRCRAFT WING
<p>COMMANDING GENERAL AWC CHIEF OF STAFF ACOS, G-1 ACOS, G-2 ACOS, G-3 ACOS, G-4 ACOS, COMPT CEO</p> <p><u>MWHG-1</u> COMMANDING OFFICER H&MS-1 MWFS-1 MWCS-1</p> <p><u>MWSG-17</u> COMMANDING OFFICER H&MS-17 WERS-17</p> <p><u>MAGC-18</u> COMMANDING OFFICER H&MS-18 MACS-4</p> <p>MASS-3</p> <p><u>MAG-11</u> COMMANDING OFFICER H&MS-11 MABS-11 VMCI-1 VMA(AW)-225</p> <p>VMA(AW)-242 VMO-2</p> <p><u>MAG-12</u> COMMANDING OFFICER H&MS-12 MABS-12</p> <p>VMA-211</p> <p><u>MAG-13</u> COMMANDING OFFICER H&MS-13 MABS-13 VMFA-115 VMFA-314 VMA-311 VMFA-122</p> <p><u>MAG-16</u> COMMANDING OFFICER H&MS-16 MABS-16</p> <p>HMH-463 HML-167 HMM-364 HMM-263</p> <p>HMM-161 HMM-262 HML-367</p>	<p>MGEN W. G. THRASH BGEN R. H. SPANJER COL R. W. TELLER COL G. S. STEWART COL J. R. WEAVER COL R. L. LAMAR COL W. C. MCGRAW COL E. J. ARTNAK LTCOL T. KALUS</p> <p>COL L. J. STIEN MAJ W. S. HUMBERT LTCOL N. F. SCHNIPPEL, JR. MAJOR A. B. RAY</p> <p>COL H. L. JENSEN LTCOL D. SERRIN MAJOR W. F. FARLEY</p> <p>COL S. G. DUNWIDDIE, JR. LTCOL H. E. HOPPEYER, JR. LTCOL R. W. MOLYNEUX, JR.</p> <p>LTCOL J. H. DUROIS</p> <p>COL N. E. HEFFERNAN LTCOL R. F. HEBERT LTCOL P. A. MANNING LTCOL B. W. FARLEY LTCOL J. J. METZKO</p> <p>LTCOL S. P. LEWIS LTCOL J. M. MORIARITY</p> <p>COL P. B. HENLEY LTCOL J. J. WENT LTCOL H. F. WITTER</p> <p>LTCOL L. GASPERINE, JR.</p> <p>LTCOL T. E. MURPHREE MAJOR F. J. HORACK MAJOR R. D. REVIE LTCOL D. P. BOWEN LTCOL T. J. KELLY MAJOR A. R. HICKLE LTCOL R. E. HOWARD, JR.</p> <p>COL J. P. BRUCE MAJOR M. T. HORNSBY LTCOL P. C. SCAGLIONE</p> <p>LTCOL C. A. BLOCK LTCOL J. E. WEBER LTCOL C. R. DUNBAUGH LTCOL W. R. LEDBETTER, JR.</p> <p>MAJOR B. H. MANN LTCOL R. A. BANCROFT LTCOL W. G. CRETNEY</p>
	<p>COMMANDING GENERAL AWC CHIEF OF STAFF ACOS, G-1 ACOS, G-2 ACOS, G-3 ACOS, G-4</p> <p><u>MWHG-3</u> COMMANDING OFFICER H&MS-3 MWFS-3 MWCS-3</p> <p><u>MHTG-30</u> COMMANDING OFFICER H&MS-30 HMHT-301 HMMT-302</p> <p><u>MAG-33</u> COMMANDING OFFICER H&MS-33 MABS-33 VMCI-3 VMA-214 VMFA-323 (CADRE) VMFAT-10J VMFA-531 VMFA-542 VMA-223</p> <p><u>MWSG-37</u> COMMANDING OFFICER H&MS-37 WERS-37 VMGR-352</p> <p><u>MAGC-38</u> COMMANDING OFFICER H&MS-38 SU#1, H&MS-38 MACS-1 MACS-3 MACS-7 1STLAAM BN 2NDLAAM BN</p> <p><u>MAG-56</u> COMMANDING OFFICER H&MS-56 MABS-56 HMH-363 HML-267 HMH-361 HMM-163 HMM-265</p> <p>MCCRTG-10 COMMANDING OFFICER H&MS-10 VMAT-102 VMT-103</p>
	<p>MGEN R. G. OWENS, JR. BGEN J. A. FEELEY, JR. COL H. N. MEHAFFEY LTCOL L. A. GULLING COL R. J. GRAHAM COL D. WILKER</p> <p>COL G. L. LILLICH LTCOL J. B. LAVELLE MAJOR J. S. LOOP MAJOR D. B. NEWTON</p> <p>COL A. F. GARROTTO LTCOL R. W. CREIGHTON LTCOL L. W. JARMAN LTCOL K. D. VANEK</p> <p>COL F. N. PIPPIN LTCOL R. H. HUTCHINSON MAJOR J. E. KEHRLE LTCOL R. E. PERCIVAL LTCOL W. R. SMITH MAJ K. A. ZIMMERMAN II LTCOL R. R. NORTON LTCOL J. L. THATCHER LTCOL K. A. SMITH LTCOL J. W. IAZZO</p> <p>COL P. E. WILSON LTCOL D. L. RICE LTCOL R. W. DUPHINEY LTCOL H. D. STOTT</p> <p>LTCOL T. I. GUNNING MAJOR F. L. HARDING MAJOR D. V. STOWELL MAJ C. F. KELLENBARGER LTCOL T. M. KAUFFMAN LTCOL D. E. ROBERTS MAJOR E. L. HOUSE, JR. MAJOR H. J. BALDWIN, JR.</p> <p>COL M. D. PORTER LTCOL G. H. BUCKNER II LTCOL F. L. YOHE LTCOL R. P. BRAY LTCOL J. M. BLANC LTCOL R. A. GOVONI LTCOL F. A. MATHEWS LTCOL R. C. COURTNEY</p> <p>COL G. FINK MAJ I. L. DRIEFER LTCOL B. A. SCHAFFER LTCOL M. T. GARRISON</p>

UNCLASSIFIED

~~SECRET~~

UNCLASSIFIED

MARINE CORPS COMMAND CENTER

MARINE CORPS PERSONNEL IN RVN

21 FEBRUARY 1970

	OFF	ENL	TOTAL
* III MAF.	3,427	48,658	52,085
DANANG	(2,996)	(42,261)	(45,257)
CHU LAI	(376)	(4,854)	(5,230)
PHU BAI	(21)	(860)	(881)
DONG HA	(34)	(683)	(717)
SU #1, 1ST ANGLICO (AT VARIOUS LOCATIONS SVN)	((21))	((194))	((215))
OTHER USMC PERSONNEL	159	149	308
MACV STAFF/MACV FIELD	(136)	(136)	(272)
NAVAJGRU/NAVY UNITS	(23)	(13)	(36)
USMC IN RVN CHARGED AGAINST PROGRAM IX	3,586	48,807	52,393
U. S. NAVY, III MAF.	256	1,784	2,040

* AS REPORTED BY III MAF DAILY ADMIN SITREP # 49 AS OF 2400, 17FEB70 AND THE MACV WEEKLY STRENGTH REPORT, AS OF 2400, 12FEB70 AS ADJUSTED BY MACV DAILY RPT OF ARR/DEP AS OF 2400, 19FEB70

Unclassified

UNCLASSIFIED

~~SECRET~~

UNCLASSIFIED

MARINE CORPS COMMAND CENTER

WESTPAC UNIT LOCATIONS

21 FEBRUARY 1970

QUANG TRI

(QUANG TRI)

- 1ST BDE, 5TH INF DIV (MECH)
- 1/77 ARMOR (OPN GREENE RIVER)
- 1/61 INF (MECH) (OPN GREENE RIVER)
- 1/11 INF (OPN GREENE RIVER)
- 3/5 ARMD CAV SQDN (OPN GREENE RIVER)

USMC ● 717
USN ● 36
USA ● 8,807

THUA THIEN

HQ, XXIV CORPS (PHU BAI)

HQ, 101st ABN DIV (AM)

- 1ST BDE, 101ST ABN DIV (AM)
 - 1/327 INF (AM) (OPN RANDOLPH GLEN)
 - 2/327 INF (AM) (OPN RANDOLPH GLEN)
 - 2/502 INF (AM) (OPN RANDOLPH GLEN)
- 2D BDE, 101ST ABN DIV (AM)
 - 1/501 INF (AM) (OPN RANDOLPH GLEN)
 - 2/501 INF (AM) (OPN RANDOLPH GLEN)
 - 1/502 INF (AM) (OPN RANDOLPH GLEN)
- 3D BDE, 101ST ABN DIV (AM)
 - 1/506 INF (AM) (OPN RANDOLPH GLEN)
 - 2/506 INF (AM) (OPN RANDOLPH GLEN)
 - 3/187 INF (AM) (OPN RANDOLPH GLEN)

USMC ● 881
USN 46
USA ● 23,265

QUANG NAM

HQS, III MAF

HQS 1ST MAR DIV (DANANG)

1ST MARINES

- 1/1
- 2/1
- 3/1

5TH MARINES

- 1/5
- 2/5
- 3/5

7TH MARINES

- 1/7
- 2/7
- 3/7

26TH MARINES

- 1/26
- 2/26
- 3/26

HQ 1st MAW
MAG-11

- VMA(AW)-242 (A-6A)
- VMA(AW)-225 (A-6A)
- VMCJ-1 (RF-4/EA-6/EF-10)
- VMO-2 (OV-10A)

MAG-16

- HML-367 (AH-1G)
- HML-167 (UH-1E)
- HMH-463 (CH-53A)
- HMM-364 (CH-46D)
- HMM-263 (CH-46D)
- HMM-262 (CH-46D)
- HMM-161 (CH-46D)

2d ROKMC BDE

- 1/2 (OPN VICTORY DRAGON XIX)
- 2/2 (OPN VICTORY DRAGON XIX)
- 3/2 (OPN VICTORY DRAGON XIX)
- 5/2 (OPN VICTORY DRAGON XIX)

USMC ● 45,257
USN ● 1,803
USA ● 1,104
ROKMC 7,145

FLC 1ST FSR/FLSG-B/1ST SERV BN

QUANG TIN/QUANG NGAI

HQ 23d INF DIV (AMERICAL) (CHU LAI)

196TH LT INF BDE

- 2/1 INF (OPN FREDERICK HILL)
- 4/31 INF (OPN FREDERICK HILL)
- 3/21 INF (OPN FREDERICK HILL)
- 1/46 INF

198TH LT INF BDE

- 1/6 INF (OPN GENEVA PARK)
- 1/52 INF (OPN GENEVA PARK)
- 5/46 INF (OPN NANTUCKET BEACH)

11TH INF BDE

- 1/20 INF (OPN IRON MOUNTAIN)
- 4/21 INF (OPN IRON MOUNTAIN)
- 3/1 INF (OPN IRON MOUNTAIN)
- 4/3 INF (OPN IRON MOUNTAIN)
- 1/1 ARMD CAV SQDN (OPN IRON MOUNTAIN)

1st MAW

MAG-12

MAG-13

- VMFA-115 (F-4B)
- VMFA-314 (F-4B)
- VMFA-122 (F-4B)
- VMA-311 (A-4E)

USMC ● 5,230
USN 116
USA ● 24,430

OKINAWA

HQ, I MEF

3D MARDIV (-)(REIN)(TF-79)

11th MEB (TF-79.1)

OSD PROGRAM VIII CEILING

ACTUALS CHARGED AGAINST PROGRAM VIII AS OF 5FEB70.

4TH MARINES

- 1/4
- 2/4
- 3/4

9TH MARINES

3/9

MAG-36

- VMGR-152 (KC-130F)
- VMO-6 (OV-10A/UH-1E)
- HMH-462 (CH-53A)

3D FSR

MCB CAMP BUTLER/NON FMF
Non-Deployable Casuals
SVN-Originated Patients

USMC 19,200
USN 934
USA 18,580
14,061 (349)
13,456 (50)
915 (25)
148
0

USMC RVN RECAP

	USMC	USN
OSD PROGRAM IX CEILING EFFECTIVE 15APR70.	42,610	2,233
ACTUALS CHARGED AGAINST PROGRAM IX AS OF 19FEB70.	52,393	2,001
III MAF	52,085	2,001
SU#1 1ST ANGLICO	(215)	(12)
OTHER	308	
MACV STAFF/MACV FIELD	(272)	
NAVAV/GRU/NAVY UNITS	(36)	

I CORPS RECAP

US MARINE CORPS	(12 Bns)	52,085
US ARMY	(25 Bns)	73,849
US NAVY		16,954
US AIR FORCE		8,194
ROKMC	(4 Bns)	6,148
RVNAF	(36 Bns)	153,895
ARVN/ABN	(36 Bns)	(74,634)
VNMC		
VNN		(2,100)
VNAF		(3,408)
VNRF		(37,403)
VNPF		(36,350)
I CORPS TOTAL	77 BN	311,125

SLF 7TH FLEET

	USMC	USN
BRAVO: BLT 2/9	1,847	60
HMM-165		
● AT SUBIC		
ALFA: BLT 1/9	1,868	85
HMM-164		
AT OKINAWA		

MOVEMENTS

Det 12th Mar and "D" Co, 3d Recon Bn, At Fuji for training.

JAPAN

	USMC	USN
OSD PROGRAM IX CEILING EFFECTIVE 15APR70.	4,700	45
ACTUALS CHARGED AGAINST PROGRAM VIII AS OF 5FEB70.	3,749	34
1ST MAW (REAR)		
MAG-15	(2,553)	(34)
VMFA-232 (F-4J)		
VMFA-334 (F-4J)		
VMA(AW)-533 (A-6A)		
VMA-211 (A-4E)		
(Less command)		

*Does NOT include 243 hospitalized SVN-Originated Patients.

Non FMF (1,196)

Unclassified

UNCLASSIFIED

* Includes only U. S. Navy Personnel organic to FMF Units.
Includes SU#1 and 1st ANGLICO at various locations throughout SVN.
● Latest Change

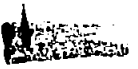

MARINE CORPS

FEB 24 1970

REFERENCE BRANCH

Unclassified

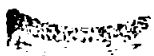

~~TOP SECRET~~
UNCLASSIFIED

MARINE CORPS COMMAND CENTER

USMC/ENEMY CASUALTIES IN RVN

21 FEBRUARY 1970

USMC BATTLE CASUALTIES

KIA/DOW	WIA(EVAC)	WIA(RTD)	MIA/PW
12,478	48,923	35,854	81/21

USMC CASUALTY FIGURES ARE PROVIDED DAILY BY HOMC CASUALTY SECTION (CODE DNA) AND REFLECT ALL CASUALTIES REPORTED AS OF 20FEB70.

USMC NON-BATTLE CASUALTIES

DEAD	INJURED	MISSING
1,514	1,822	13

FIGURES INDICATED AS INJURED ARE ONLY THOSE IN SERIOUS (CRITICAL INJURY OR DISEASE CATEGORY AND DO NOT INCLUDE THOSE OF A MINOR NATURE

USMC INFLECTED ENEMY CASUALTIES

FIA	PW	WPNS
80,765	4,202	20,815

ENEMY CASUALTIES ARE COMPILED DAILY FROM THE III MAF HISSUM AND ARE RECONCILED MONTHLY WITH THE FMEPAC SUMMARY OF USMC OPERATIONS IN RVN

TYPICAL DISPOSITION OF 100 USMC WIA *

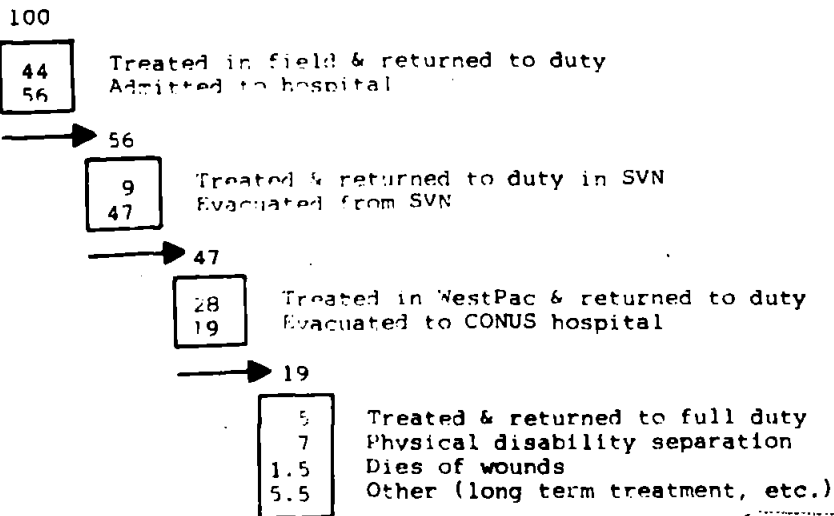

*54,081 CASUALTIES, JAN67-DEC68.

UNCLASSIFIED
Unclassified

UNCLASSIFIED

COMPARATIVE USMC/ENEMY KIA

21 FEBRUARY 1970

1969

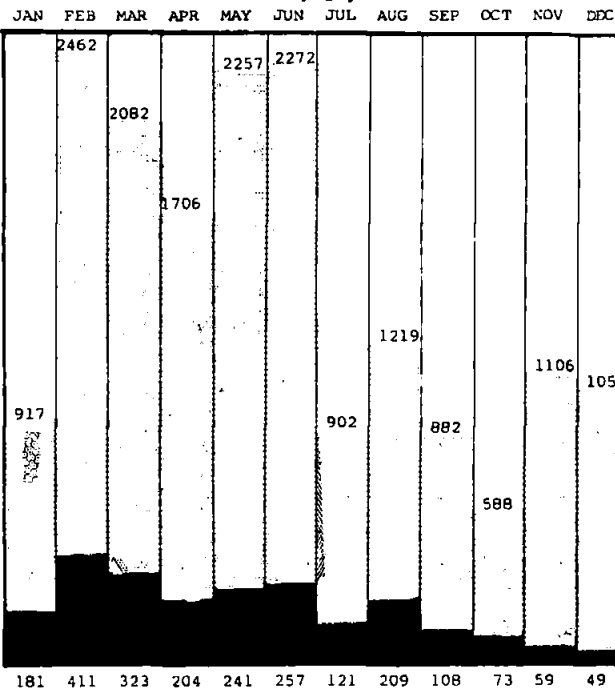

2400
2300
2200
2100
2000
1900
1800
1700
1600
1500
1400
1300
1200
1100
1000
900
800
700
600
500
400
300
200
100
0

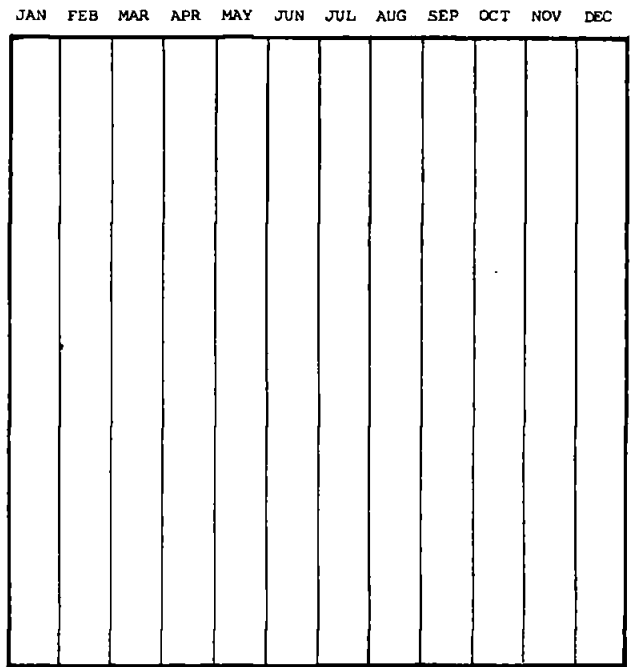

1969	
USMC	ENEMY
181	917
411	2462
323	2082
204	1706
241	2257
257	2272
121	902
209	1219
108	882
73	588
59	1106
49	1051
2,236	17,444

1970	
USMC	ENEMY
66	1027
TOTAL	

1970

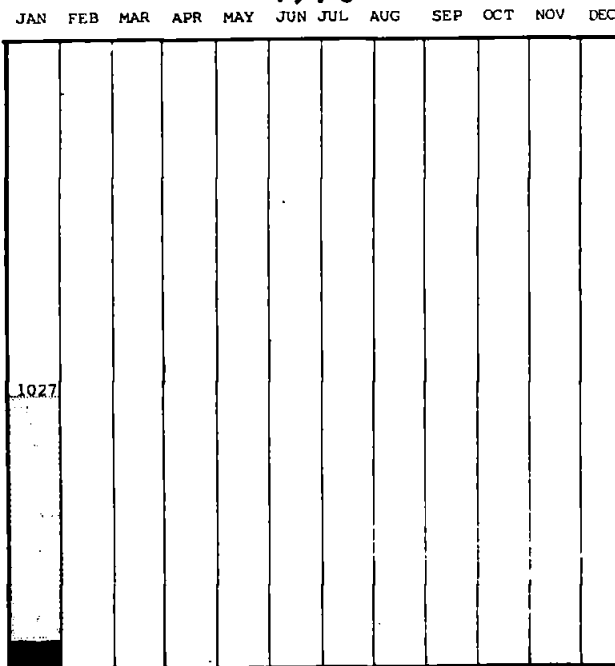

2400
2300
2200
2100
2000
1900
1800
1700
1600
1500
1400
1300
1200
1100
1000
900
800
700
600
500
400
300
200
100
0

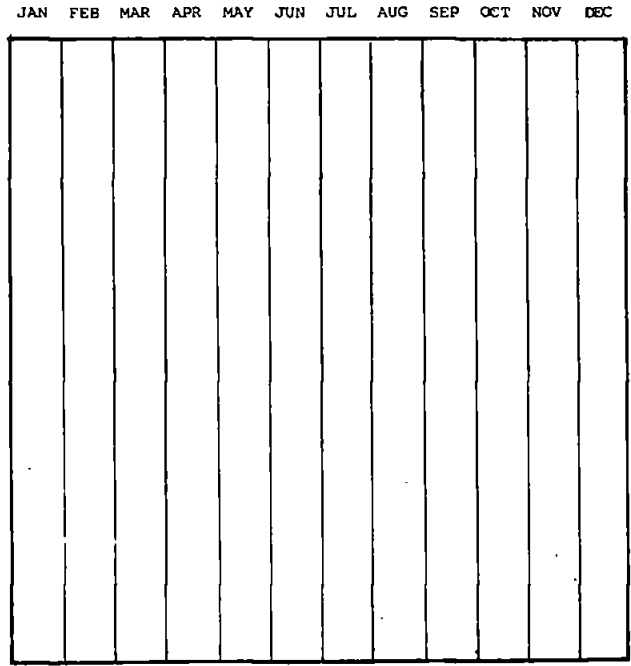

UNCLASSIFIED

MARINE CORPS COMMAND CENTER

UNCLASSIFIED

SPECIAL LANDING FORCE, 7TH FLEET

SLF BRAVO

21 FEBRUARY 1970

TASK GROUP 79.5 CTG: COL G. G. CHAMBERS JR	STRENGTH				ARMS & EQUIPMENT	LOCATION					
	USMC		USN								
UNITS EMBARKED	OFF	ENL	OFF	ENL							
SLF HQS DET					8 M29 81MM MORTARS 3 M40 106MM RR 6 M30 107MM MORTARS 4 M101A1 105MM HOW 4 M48 90MM TANKS 5 LVTP-5	AT SUBIC					
BLT 2/9 (LTCOL J. R. VANDENELZEN) 2D BN, 9TH MARINES W/2/12 E/2/12 PLAT. CO "B", 1ST AMTRAC PLAT. CO "C", 3D ENGR BN PLAT. CO "C", 3D SP BN PLAT. CO "C", 3D MT BN PLAT. CO "C", 3D RECON BN PLAT. CO "A", 3D TK BN CLEAR PLAT. CO "B", 3D MED SQD. MP CO, 3D MARDIV DET. HQBN, 3D MARDIV DET. COMM PLT. HQ CO, 9TH MAR DET. COMM SPT CO, 7TH COMM DET. 3D DENTAL CO LSU	52	1500	1	56			SHIPPING USS NEW ORLEANS (LPH-11) USS THOMASTON (LSD-28) USS VANCOUVER (LPD-2) USS WHITFIELD CTY (LST-1169)				
HMM-165 (LTCOL P. H. MITCHELL)	69	226	1	2				AIRCRAFT 18/CH-46A	SUPPLIES CLASS I CLASS II CLASS III CLASS IV CLASS V		
TOTALS	121	1726	2	58							

SLF ALFA

18 FEBRUARY 1970

TASK GROUP 79.4 CTG: COL C. W. BOYD, JR.	STRENGTH				ARMS & EQUIPMENT	LOCATION					
	USMC		USN								
UNITS EMBARKED	OFF	ENL	OFF	ENL							
SLF HQS DET					12 M10 60MM MORTARS 8 M29 81MM MORTARS 8 M40 106 MM RR 6 M30 107 MM MORTARS 6 M101A1 105 MM HOW 5 M48 90MM TANKS	AT OKINAWA					
BLT 1/9 (LTCOL D. J. MC ADAMS) 1ST BN, 9TH MARINES MORT BTRY, 2/12 BTRY "D" (REIN), 2/12 PLAT. CO "B", 1ST AMTRACBN PLAT. CO "C", 3D ENGR BN PLAT. CO "C", 3D SP BN PLAT. CO "A", 3D MT BN PLAT. CO "C", 3D RECON BN PLAT. CO "C", 3D TK BN CLEAR PLT. CO "B", 3D MED BN SQD. MP CO, 3D MARDIV DET. HQ BN DET. COMM PLT HQ CO, 9TH MAR DET. 3D DENTAL CO LSU DET BMU NBG	54	1596	6	76			SHIPPING				
HMM-164 (LTCOL R. D. FOWNER)	41	177	1	2				AIRCRAFT 19 /CH-46A's	SUPPLIES CLASS I 30 DAYS CLASS II 30 DAYS CLASS III 30 DAYS CLASS IV 30 DAYS CLASS V 30 DAYS		
TOTALS	95	1773	7	78							

~~CONFIDENTIAL~~
UNCLASSIFIED

~~CONFIDENTIAL~~
UNCLASSIFIED

SUMMARY OF MARINE CORPS AMPHIBIOUS OPERATIONS IN SOUTH VIETNAM

21 FEBRUARY 1970

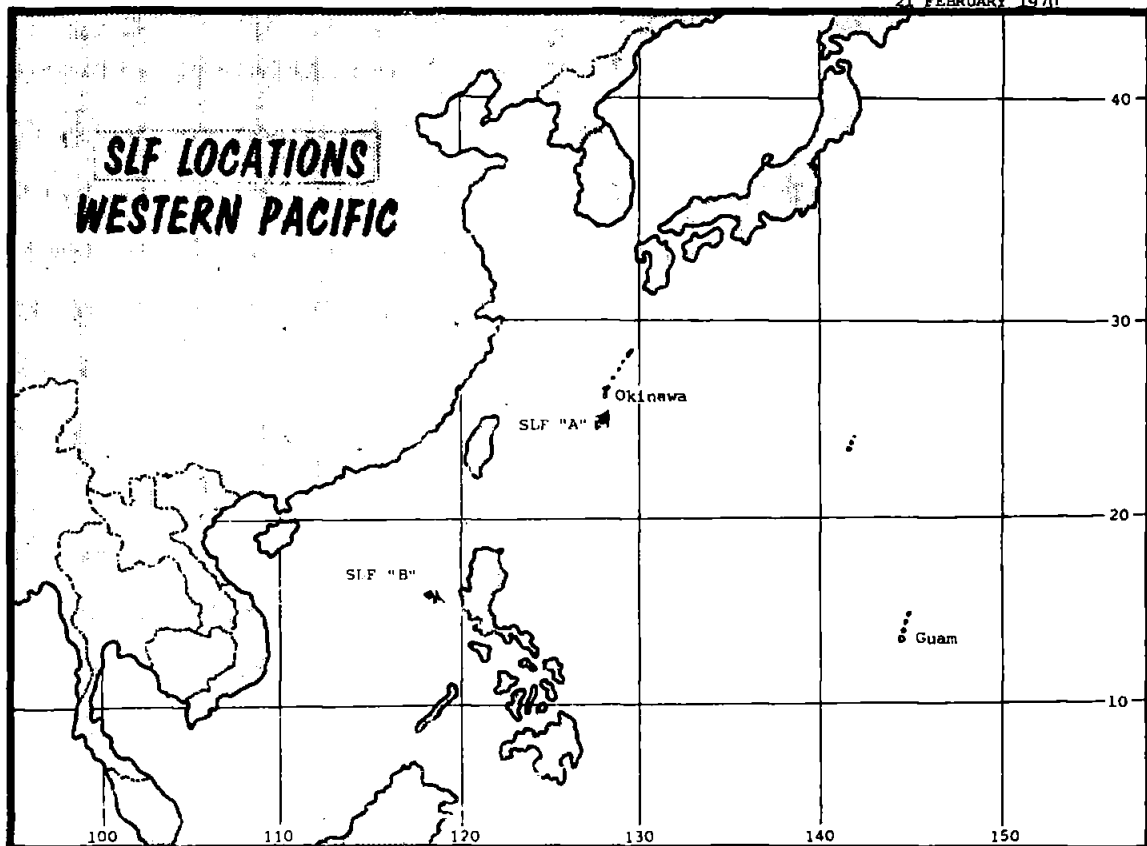

TOTAL AMPHIBIOUS OPERATIONS 71

(INCLUDING SLF OPERATIONS AS INDICATED ON THIS
AND SUBSEQUENT PAGES)

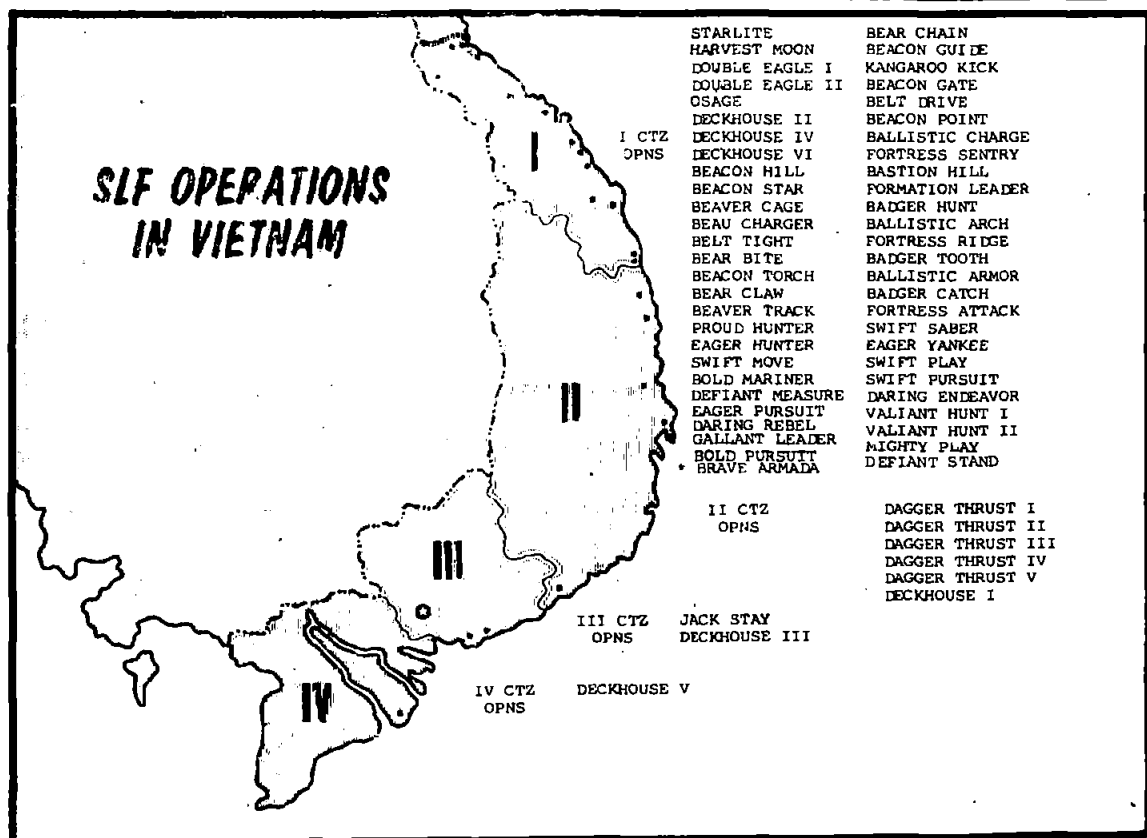

SUMMARY OF SLF OPERATIONS ON FOLLOWING PAGE

22-2

~~CONFIDENTIAL~~
UNCLASSIFIED
Unclassified

UNCLASSIFIED

DISPOSITION OF MAJOR US & FWMAF UNITS IN RVN

CTZ RECAP

<p>I CORPS* 220 MILES LENGTH 14,600 SQ MI AREA USMC 12 BNS USA 25 BNS ARVN 36 BNS ROKMC 4 BNS</p> <p>TOTAL 77 BNS</p>	<p>III MAF 30-75 MILES WIDTH 2,860,300 CIV POP 1ST MAR DIV 1ST BDE, 5TH INF DIV (MECH) 23D INF DIV (AMERICAN) 101ST ABN DIV (AM) 2D ROKMC BDE</p>
<p>II CORPS* 315 MILES LENGTH 31,300 SQ MI AREA USA 17 BNS ARVN 31 BNS ROK 18 BNS</p> <p>TOTAL 66 BNS</p>	<p>I FORCEV 45-130 MILES WIDTH 2,298,200 CIV POP 4TH INF DIV 173D ABN BDE ROK CAP INF DIV 9TH ROK DIV</p>
<p>III CORPS* 90 MILES LENGTH 10,100 SQ MI AREA USA 39 BNS ARVN 55 BNS AUSTRALIA 3 BNS THAILAND 6 BNS</p> <p>TOTAL 103 BNS</p>	<p>II FORCEV 55-115 MILES WIDTH 5,133,000 CIV POP 1ST INF DIV 9TH INF DIV (-) 25TH INF DIV ROYAL THAI VOL REGT 1ST AUSTRALIAN TF 1ST CAV DIV (AM)</p>
<p>IV CORPS* 195 MILES LENGTH 14,600 SQ MI AREA USA 0 BNS ARVN 47 BNS</p> <p>TOTAL 47 BNS</p>	<p>35-115 MILES WIDTH 5,700,1000 CIV POP</p>

* Coastal Arc * See RVN Recap note
Includes 3 RGR Bns

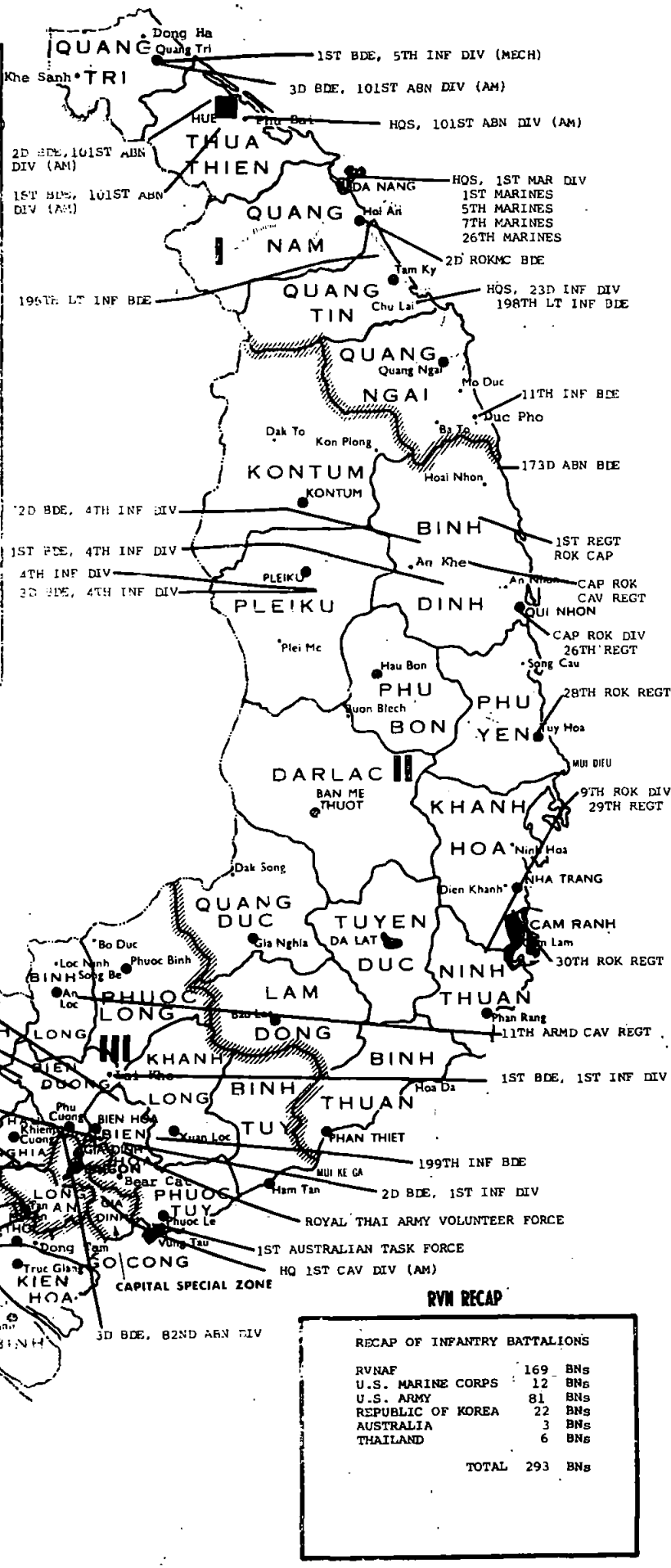

RVN RECAP

RECAP OF INFANTRY BATTALIONS	
RVNAF	169 BNS
U.S. MARINE CORPS	12 BNS
U.S. ARMY	81 BNS
REPUBLIC OF KOREA	22 BNS
AUSTRALIA	3 BNS
THAILAND	6 BNS
TOTAL	293 BNS

UNCLASSIFIED

UNCLASSIFIED
~~CONFIDENTIAL~~

21 FEBRUARY 1970

MARINE CORPS COMMAND CENTER

MILITARY FORCES IN RVN *

RVN ARMED FORCES (RVNAF)

ARMY (ARVN)	416,278
NAVY (VNN)	30,143
AIR FORCE (VNAF)	36,469
MARINE CORPS (VNMC)	11,528
REGIONAL FORCES (RF)	260,455
POPULAR FORCES (PF)	214,383
TOTAL RVNAF	969,256

UNITED STATES FORCES

ARMY	333,615
NAVY	29,128
AIR FORCE	56,553
MARINE CORPS	52,393
COAST GUARD	369
TOTAL U.S.	472,058

FREE WORLD MILITARY ASSISTANCE FORCES (FWMAF)

REPUBLIC OF KOREA	48,871
AUSTRALIA	7,696
PHILIPPINES	142
THAILAND	11,568
NEW ZEALAND	557
REPUBLIC OF CHINA	28
SPAIN	11
TOTAL FWMAF	68,873

TOTAL FORCES IN RVN 1,510,187

SOURCE: RVNAF MACV MONTHLY STRENGTH REPORT. ALL OTHER:
MACV WEEKLY STRENGTH REPORT AS OF 2400, 12FEB70.
USMC STRENGTH: MACV WEEKLY STRENGTH REPORT AS
ADJUSTED BY MACV RPT OF ARR/DEP AS OF 2400, 19FEB70.

UNCLASSIFIED
~~CONFIDENTIAL~~

~~CONFIDENTIAL~~
UNCLASSIFIED

MARINE CORPS COMMAND CENTER

LANDING FORCE, SIXTH FLEET 3-69

21 FEBRUARY 1970

TF-61/62 CTG: LTCOL G. B. CRIST UNITS EMBARKED	STRENGTH				ARMS & EQUIPMENT	LOCATION AT ATHENS
	USMC		USN			
	OFF	ENL	OFF	ENL		
BLT 2/6 (LTCOL G. B. CRIST)					31 7.62 MG 10 LVTP-5 6 105 HOW 5 90MM GUN TANK 5 ONTOS 8 81MM MORTARS 8 FLAME THROWERS 6 106MM RR	SHIPPING USS CAMBRIA (APA-36) USS LASALLE (LPD-3) USS RUSHMORE (LSD-14) USS WAHIAKUM (LST-1162)
2D BN, 6TH MAR	49	1030	4	33		
DET HQCO, 6TH MAR					21 MULES 32 MITES 22 2 1/2 TON TRUCKS 8 JEEPS 3 5 TON CARGO TRUCKS 9 3/4 TON UTIL TRUCKS 4 AMBULANCES 4 CRANES	SUPPLIES CLASS I CLASS II CLASS III CLASS IV CLASS V
BTRY "E", 2/10	9	124				
DET HQ BTRY, 2/10	2	10		2	AIRCRAFT NO AIRCRAFT	
PLT CO "C", 2D AMTRAC BN	1	45				
PLT CO "B", 8TH MT BN		19				
PLT CO "C", 2D AT BN	1	21				
PLT CO "B", 2D ENGR BN		49				
PLT CO "A", 2D MED BN		10	1	9		
PLT CO "A", 2D TK BN	1	24				
PLT CO "A", 2D SP BN	1	49				
PLT CO "B", 2D RECON BN	1	24		1		
DET HQBN, 2D MARDIV		27				
DET 2D DENTAL CO			2	2		
DET 2D SERVICE BN	1	42				
DET 2D FSR		40				
TOTALS	66	1514	7	47		

LANDING FORCE, CARIBBEAN 1-70

20 FEBRUARY 1970

TASK GROUP 45.9 CTG: COL G. R. HUNTER UNITS EMBARKED	STRENGTH				ARMS & EQUIPMENT	LOCATION AT LIBERTY PORTS
	USMC		USN			
	OFF	ENL	OFF	ENL		
HQ 36TH MEU BLT 3/2 (LTCOL E. F. PIERSON JR.)					11 LVTP-5 5 M48 TANK 5 M50 ONTOS 6 105MM HOW TD 8 106MM RR 8 81MM MORTAR	SHIPPING USS GUADALCANAL (LPH-7) USS VERMILLION (LKA-107) USS SUFFOLK CTY (LST-1173) USS SPEIGEL GROVE (LSD-32)
3D BN, 2D MARINES	44	1007	4	38		
BTRY "I", 3/10	10	136	1	2	AIRCRAFT 19 CH-46D	SUPPLIES CLASS I CLASS II CLASS III CLASS IV CLASS V
DET HQ BTRY, 3/10						
PLT CO "B", 2D AMTRAC BN	1	40				
PLT CO "C", 2D MT BN	1	33				
PLT CO "A", 2D AT BN	1	21				
PLT CO "A", 2D ENGR BN	1	49				
PLT H&S CO, 2D MED BN		10		17		
PLT CO "A", 2D TANK BN	1	24				
PLT CO "A", 2D SP BN	1	52		7		
PLT CO "C", 2D RECON BN	1	23		1		
DET HQBN, 2D MARDIV	1	25				
DET 2D DENTAL CO			1	1		
DET 2D SERV BN	1	40				
DET 2D FSR	1	37				
DET HQCO 2D MARINES		20				
HMM-261 (LTCOL V. M. HAZELBAKER)	43	170	1			
TOTALS	107	1687	7	61		

~~CONFIDENTIAL~~
UNCLASSIFIED

UNCLASSIFIED

SUMMARY OF MAJOR RVNAF OPERATIONS

OPERATION (DATE COMMENCED)	UNITS INVOLVED	LOCATION	CASUALTIES AS OF : 222400H FEB70		
			FRIENDLY		ENEMY
			KIA	WIA	KIA
LAM SON 350 (1JAN70)	2ND REGT: 1/2, 2/2, 3/2, 4/2 & 5/2	5 KM E OF GIO LINH	17	23	174
LAM SON 353 (1JAN70)	7TH CAV: 3/7 CAV	5 KM SE OF GIO LINH	4	23	28
LAM SON 354 (6JAN70)	54TH REGT: 3/54	6 KM S OF QUANG TRI CITY	1	2	1
LAM SON 352 (1JAN70)	54TH REGT: 1/54, 2/54 & 4/54	2 KM NW OF PHU BAI	1	6	29
LAM SON 349 (1JAN70)	1ST REGT: 1/1, 2/1, 3/1 & 4/1	21 KM NW OF A LUOI	11	43	169
LAM SON 351 (1JAN70)	3RD REGT: 1/3, 2/3, 3/3 & 4/3	25 KM SW OF HUE	5	13	49
HUNG QUANG 1/22 (12JAN70)	51ST REGT: 2/51 & 4/51	16 KM NW OF HOI AN	1	14	3
HUNG QUANG 1/25 (19FEB70)	51ST REGT: 1/51 & 3/51	5 KM NNW OF AN HOA	3	3	NONE
QUYET THANG 54 (2JAN70)	5TH REGT: 1/5, 2/5, 3/5, 4/5 & 4/6	12 KM W OF TAM KY	21	51	183
DUONG SON 3/70 (11FEB70)	1ST ARM BDE: 37TH & 39TH RGR BNS & 2/17 & 3/17 ACAT	30 KM NW OF TAM KY	36	92	356
QUYET THANG 63 (2JAN70)	6TH REGT: 1/6 & 3/6	18 KM NW OF QUANG NGAI CITY	19	103	107
QUYET THANG 45 (4JAN70)	4TH REGT: 1/4, 2/4, 3/4 & 4/4	11 KM SW OF DUC PHO	21	63	258

ALL UNITS ARE ARVN UNLESS DESIGNATED

* - ADJUSTED

- FINAL CUMULATIVE CASUALTIES

UNCLASSIFIED

Unclassified

UNCLASSIFIED

SUMMARY OF MAJOR US AND FWMAF OPERATIONS

OPERATION (DATE COMMENCED)	UNITS INVOLVED	LOCATION	CASUALTIES AS OF : 232400H FEB70		
			FRIENDLY		ENEMY
			KIA	WIA	KIA
GREENE RIVER (19JAN70)	1ST BDE, 5TH INF DIV (MECH); 4 USA BNS	EASTERN QUANG TRI PROVINCE	5	130	71
RANDOLPH GLEN (7DEC69)	101ST ABN DIV (AM); 9 USA BNS	QUANG TRI & THUA THIEN PROVINCES	65	290	449
VICTORY DRAGON XIX (1JAN70)	2D ROKMC BDE; 4 ROKMC BNS	HOI AN AREA	2	13	23
FREDERICK HILL (18MAR69)	196TH INF BDE; 3 USA BNS	QUANG TIN PROVINCE	389	2,412	4,574
GENEVA PARK (18JUL69)	198TH INF BDE; 2 USA BNS	QUANG TIN & QUANG NGAI PROVINCES	132	874	1,240
NANTUCKET BEACH (20JUL69)	198TH INF BDE; 1 USA BN	CENTERED 15 KM NE OF QUANG NGAI CITY	24	224	250
IRON MOUNTAIN (18MAR69)	11TH INF BDE; 5 USA BNS	QUANG NGAI PROVINCE	*291	*1,681	2,553

* - ADJUSTED
- FINAL CUMULATIVE CASUALTIES

UNCLASSIFIED

Unclassified

~~CONFIDENTIAL~~

MARINE CORPS COMMAND CENTER

UNCLASSIFIED

SELECTED PERSONNEL AND AIRCRAFT DATA

PERSONNEL

24 FEBRUARY 1970

	STRENGTH	PERCENT USMC	PERCENT FMF	PERCENT FMFPAC
USMC TOTAL	300,982 *	100.00		
FLEET MARINE FORCES	153,295	50.93	100.00	
FMF ATLANTIC	45,696 \$	15.18	29.81	
FMF PACIFIC	107,599 #	35.75	70.19	
VIETNAM	52,042 †	17.42	34.21	48.74

SOURCE: * MONTHLY USMC PERSONNEL ALLOCATION REPORT OF 30NOV69.
 \$ MCCC UNIT REPORT OF 12FEB70.
 # MCCC UNIT REPORT OF 4FEB70.
 † MACV WEEKLY STRENGTH REPORT AS OF 2400, 19FEB70 AS ADJUSTED BY THE MACV DAILY RPT OF ARR/DEP AS OF 2400, 22FEB70.

AIRCRAFT

5 FEBRUARY 1970

	FIXW	HELO	TOTAL	PERCENT USMC	PERCENT FMF	PERCENT FMFPAC
USMC TOTALS	1013	569	1582	100.00		
FLEET MARINE FORCES	763	543	1306	82.55	100.00	
FMF ATLANTIC	303	156	459	29.01	35.15	
FMF PACIFIC	460	387	847	53.54	64.85	
VIETNAM	156	178	334	21.11	25.57	39.43

SOURCE: MARINE CORPS COMMAND CENTER UNIT REPORT OF 31DEC69.

UNCLASSIFIED

Unclassified

~~CONFIDENTIAL~~

UNCLASSIFIED

FLEET MARINE FORCE DEPLOYMENTS

24 FEBRUARY 1970



1ST MAR BRIG
HAWAII

I MEF

OKINAWA & JAPAN

DET, 12THMAR; "D" CO,
3D RECON BN AT FUJI
FOR TRNG.

10TH MARINES
DET, 2D FAG
DET 1, HMM-264
AT VIEQUES FOR FIREX,
ETD 25MAR70 FOR
CAMLEJ.

GITMO AUGMENT

2D BN, 8TH MAR
BTRY B/1/10
PLT, 2D TK BN
PLT, 2D ANGLICO
DET, FSR

LANFORCARIB 1-70

BLT 3/2 & HMM-261
ENR GITMO
ETA 27FEB70

LANFOR6THFLT 3-69

AT ATHENS

III MAR

RVN

SLF, 7TH FLEET

SLF ALFA

AT OKINAWA

SLF BRAVO

AT SUBIC

DISTRIBUTION OF MAJOR FMF UNITS

	INF BNS	VMFA	VMA	VMA(AW)	VMCI	BMH	HMH	HML	VMO	VMGR
WESTPAC	18	5	2	3	1	6	2	2	2	1
RVN	(12)	(3)	(1)	(2)	(1)	(4)	(1)	(2)	(2)	
OKINAWA/JAPAN	(4)	(2)	(1)*	(1)			(1)		(1)	(1)
ASSIGNED TO SLF'S	(2)					(2)				
MIDPAC	1	2								
HAWAII AFLOAT	(1)	(2)								
EASTPAC	2	**3	2		1	2	2	1		1
WEST COAST AFLOAT	(2)	(3)	(2)		(1)	(2)	(2)	(1)		(1)
ATLANTIC	8	5	2	3	1	4	2		1	1
EAST COAST CARIBBEAN	(6) (2)	(5)	(2)	(3)	(1)	(3) (1)	(2)		(1)	(1)
EUROPE	1									
MEDITERRANEAN	(1)									
GRAND TOTAL	30	15	6	6	3	12	6	3	3	3

* ENROUTE IWAKUNI.
** VMFA-323 IN CADRE STATUS.

UNCLASSIFIED

~~CONFIDENTIAL~~

Unclassified

UNCLASSIFIED

DISTRIBUTION OF PERSONNEL

FLEET MARINE FORCE, PACIFIC

24 FEBRUARY 1970

UNIT	NOTE	ASSIGNED STRENGTH		STR RPT DATE	DANANG		CHU LAI		PHU BAI		No 1 CTZ		OKINAWA		JAPAN		HAWAII		EASTPAC		OTHER	
		USMC	USN		USMC	USN	USMC	USN	USMC	USN	USMC	USN	USMC	USN	USMC	USN	USMC	USN	USMC	USN	USMC	USN
MEDICAL																						
1ST MED BN		176	363		176	363																
3D MED BN		171	247										93	194					78	53		
1ST HOSP CO		42	60		42	60																
1ST DENTAL CO			66			66																
3D DENTAL CO		3	81										3	81								
11TH DENTAL CO			4	74		4	74															
13TH DENTAL CO				33																		33
5TH DENTAL CO			3	42														00	00		3	42
3D HOSP CO			36	63																	36	63
	USMC	76,601			38,481		1,569		685		789		16,523		000		3,553		13,145		1,856	
	USN	3,431			1,824		21		7		13		889		000		109		514		54	
	GROUND TOTAL	80,032			40,305		1,590		692		802		17,412		000		3,662		13,659		1,910	

AVIATION UNITS

UNIT	NOTE	USMC	USN	DANANG	CHU LAI	PHU BAI	No 1 CTZ	OKINAWA	JAPAN	HAWAII	EASTPAC	OTHER
HQ SQDN FMFPAC		61								61		
1ST MAW												
MWHG-1												
H&HS-1		793	37	793	37							
MMFS-1		163		163								
MMCS-1		225		225								
MWSG-17												
H&MS-17		735	20	735	20							
WERS-17		248		248								
MACG-18												
H&HS-18		224	10	224	10							
MABS-3		312	2	312	2							
MACS-4		331	3	331	3							
MAG-11												
H&MS-11		626		626								
MABS-11		540	27	540	27							
VMC-1		329	1	329	1							
VMA(AW)-225		197	1	197	1							
VMA(AW)-242		207	1	207	1							
VMO-2		143		143								
MAG-12												
H&MS-12		442		442								
MABS-12		558	27	558	27							
VMA-211		143	1	143	1							
MAG-13												
H&MS-13		455		455								
MABS-13		525	34	525	34							
VMEFA-115		240	1	240	1							
VMEFA-314		243	1	243	1							
VMEFA-122		246	1	246	1							
MATCU-67		78		78								
VMA-311		168	1	168	1							
MAG-16												
H&MS-16		468		468								
MABS-16		937	28	937	28							
MATCU-68		73		73								
HML-167		250		250								
HML-364		211	1	211	1							
HML-463		186		186								
HML-263		199	1	199	1							
HML-367		202	2	202	2							
HML-161		210		210								
HML-262		229	1	229	1							
MCAS IWAKUNI	B	1200							1200			
1ST MAW (REAR)												
H&HS-1 (REAR)		417	5					417	5			
MAG-15												
H&MS-15		565						565				
SUR-2 NWS		54						54				
MABS-15		456	20					456	20			
MATCU-60		68						68				
VMEFA-232		276						276				
VMEFA-334		275	1					275	1			
VMA(AW)-533		224						224				
MABS-7		156	1					156	1			
MATCU-62		57						57				
MACG-18 (REAR)												
H&S-18 (REAR)		61						61				
MCAF FUTEWA	B	356						356				
MAG-36												
H&MS-36		509						509				
MABS-36		496	10					496	10			
MATCU-66		48						48				
VMEFA-152		411	5					411	5			
HML-165		186	3								186	3
HML-164		189	5					189	5			
HML-452		189						189				
VMO-6		189	4					189	4			
MACS-8		47	24					47	24			

Unclassified

UNCLASSIFIED

UNCLASSIFIED

DISTRIBUTION OF PERSONNEL

FLEET MARINE FORCE, PACIFIC

24 FEBRUARY 1970

UNIT	NOTE	ASSIGNED STRENGTH		STRENGTH RPT DATE	DANANG		CHU LAI		PHU BAI		No I CTZ		OKINAWA		JAPAN		HAWAII		EASTPAC		OTHER		
		USMC	USN		USMC	USN	USMC	USN	USMC	USN	USMC	USN	USMC	USN	USMC	USN	USMC	USN	USMC	USN	USMC	USN	USMC
1ST BRIG																							
MAG-24																							
H&MS-24																							
MABS-24																							
MACS-2																							
MATCU-70																							
VMFA-212																							
VMFA-235																							
3D MAW																							
MWHG-3																							
H&HS-3																							
MWFS-3																							
MMCS-3																							
MCCRTG-10																							
H&MS-10																							
VMAT-102																							
VMT-103																							
MHTG-30																							
H&MS-30																							
HMHT-301																							
HMMT-302																							
MAG-33																							
H&MS-33																							
MABS-33																							
MATCU-65																							
VMCJ-3																							
VMA-223																							
VMA-214																							
VMFA-531																							
VMFA-542																							
VMFA-323 (CADRE)																							
VMFAT-101																							
MWSG-37																							
H&MS-37																							
WERS-37																							
VMGR-352																							
MACG-38																							
H&HS-38																							
MACS-1																							
MACS-3																							
MACS-7																							
1ST LAAM BN																							
2ND LAAM BN																							
MAG-56																							
H&MS-56																							
MABS-56																							
MATCU-74																							
HMM-163																							
HML-267																							
HMM-265																							
HMH-363																							
MATCU-75																							
HMH-361																							
AVIATION TOTAL																							
USMC																							
USN																							

RECAPITULATION OF FMFPAC PERSONNEL DISTRIBUTION

		ASSIGNED STRENGTH	DANANG	CHU LAI	PHU BAI	No I CTZ	OKINAWA	JAPAN	HAWAII	EASTPAC	OTHER
GROUND TOTAL	USMC	76,601	38,481	1,569	685	789	16,523	0	3,553	13,145	1,856
	USN	3,431	1,824	21	7	13	889	0	109	514	54
AVIATION TOTAL	USMC	30,998	8,068	3,098	0	0	2,434	3,809	1,649	11,754	186
	USN	458	135	66	0	0	48	27	27	152	3
GRAND TOTAL	USMC	107,599	46,549	4,667	685	789	18,957	3,809	5,202	24,899	2,042
	USN	3,889	1,959	87	7	13	937	27	136	666	57

- NOTES:**
- FIGURES IN "OTHER" ASSIGNED TO SLP'S.
 - FIGURES IN "OTHER" ASSIGNED TO VARIOUS LOCATIONS IN RVN.
 - PERSONNEL IN "OTHER" ARE ASSIGNED TO 1T, 1TT, SSC, CIT, RED EYE AND NUCLEAR ORDNANCE PLATOONS.
 - STRENGTH INCLUDED IN 1ST AND 3D TANK BATTALIONS.
 - THE 559 PERSONNEL LISTED IN "OTHER" ARE HOSPITALIZED AT LOCATIONS OTHER THAN OKINAWA, BUT ARE CARRIED ON THE ROLLS OF CASUAL COMPANY, MCB, CAMP BUTLER.
 - AT SUBIC
 - ENROUTE EASTPAC.
 - PERSONNEL ARE NON-FMF CARRIED FOR OSD PROGRAM STRENGTH TOTALS ONLY.
 - UNLESS OTHERWISE NOTED, STRENGTHS AND LOCATION ARE THOSE REPORTED BY UNIT PERSONNEL STRENGTH REPORTS AND DO NOT REFLECT DAY-TO-DAY ADJUSTMENTS BETWEEN PERIODS.
 - UNLESS OTHERWISE NOTED STRENGTH REPORT DATE IS 12FEB70.

Unclassified

UNCLASSIFIED

~~SECRET~~
UNCLASSIFIED

MARINE CORPS COMMAND CENTER

MARINE CORPS PERSONNEL IN RVN

24 FEBRUARY 1970

	OFF	ENL	TOTAL
* III MAF.	3,421	48,312	51,733
DANANG	(2,990)	(41,915)	(44,905)
CHU LAI	(376)	(4,854)	(5,230)
PHU BAI	(21)	(860)	(881)
DONG HA	(34)	(683)	(717)
SU #1, 1ST ANGLICO (AT VARIOUS LOCATIONS SVN)	((21))	((194))	((215))
OTHER USMC PERSONNEL	159	150	309
MACV STAFF/MACV FIELD	(136)	(137)	(273)
NAVADVGRU/NAVY UNITS	(23)	(13)	(36)
USMC IN RVN CHARGED AGAINST PROGRAM IX	3,580	48,462	52,042
U. S. NAVY, III MAF.	255	1,762	2,017

* AS REPORTED BY III MAF DAILY ADMIN SITREP # 49 AS OF 2400, 17FEB70 AND THE MACV WEEKLY STRENGTH REPORT, AS OF 2400, 19FEB70 AS ADJUSTED BY MACV DAILY RPT OF ARR/DEP AS OF 2400, 22FEB70.

Unclassified

UNCLASSIFIED
~~SECRET~~

WESTPAC UNIT LOCATIONS

24 FEBRUARY 1970

QUANG TRI

(QUANG TRI)

- 1ST BDE, 5TH INF DIV (MECH)
- 1/77 ARMOR (OPN GREENE RIVER)
- 1/61 INF (MECH) (OPN GREENE RIVER)
- 1/11 INF (OPN GREENE RIVER)
- 3/5 ARMD CAV SQDN (OPN GREENE RIVER)

USMC 717
USN 36
USA 8,807

THUA THIEN

HQ, XXIV CORPS (PHU BAI)

HQ, 101st ABN DIV (AM)

- 1ST BDE, 101ST ABN DIV (AM)
 - 1/327 INF (AM) (OPN RANDOLPH GLEN)
 - 2/327 INF (AM) (OPN RANDOLPH GLEN)
 - 2/502 INF (AM) (OPN RANDOLPH GLEN)
- 2D BDE, 101ST ABN DIV (AM)
 - 1/501 INF (AM) (OPN RANDOLPH GLEN)
 - 2/501 INF (AM) (OPN RANDOLPH GLEN)
 - 1/502 INF (AM) (OPN RANDOLPH GLEN)
- 3D BDE, 101ST ABN DIV (AM)
 - 1/506 INF (AM) (OPN RANDOLPH GLEN)
 - 2/506 INF (AM) (OPN RANDOLPH GLEN)
 - 3/187 INF (AM) (OPN RANDOLPH GLEN)

USMC 881
USN 46
USA 23,265

QUANG NAM

HOS 1ST MAR DIV (DANANG)

- 1ST MARINES
- 1/1
 - 2/1
 - 3/1

- 5TH MARINES
- 1/5
 - 2/5
 - 3/5

- 7TH MARINES
- 1/7
 - 2/7
 - 3/7

- 26TH MARINES
- 1/26
 - 2/26
 - 3/26

HOS, III MAF

HQ 1st MAW
MAG-11

- VMA(AW)-242 (A-6A)
- VMA(AW)-225 (A-6A)
- VMCJ-1 (RF-4/EA-6/EF-10)
- VMO-2 (OV-10A)

MAG-16

- HML-367 (AH-1G)
- HML-167 (UH-1E)
- HMH-463 (CH-53A)
- HMM-364 (CH-46D)
- HMM-263 (CH-46D)
- HMM-262 (CH-46D)
- HMM-161 (CH-46D)

2d ROKMC BDE

- 1/2 (OPN VICTORY DRAGON XIX)
- 2/2 (OPN VICTORY DRAGON XIX)
- 3/2 (OPN VICTORY DRAGON XIX)
- 5/2 (OPN VICTORY DRAGON XIX)

USMC 44,905
USN 1,803
USA 1,104
ROKMC 7,145

FLC 1ST FSR/FLSG-B/1ST SERV BN

QUANG TIN/QUANG NGAI

HQ 23d INF DIV (AMERICAN) (CHU LAI)

- 196TH LT INF BDE
- 2/1 INF (OPN FREDERICK HILL)
 - 4/31 INF (OPN FREDERICK HILL)
 - 3/21 INF (OPN FREDERICK HILL)
 - 1/46 INF

- 198TH LT INF BDE
- 1/6 INF (OPN GENEVA PARK)
 - 1/52 INF (OPN GENEVA PARK)
 - 5/46 INF (OPN NANTUCKET BEACH)

- 11TH INF BDE
- 1/20 INF (OPN IRON MOUNTAIN)
 - 4/21 INF (OPN IRON MOUNTAIN)
 - 3/1 INF (OPN IRON MOUNTAIN)
 - 4/3 INF (OPN IRON MOUNTAIN)
 - 1/1 ARMD CAV SQDN (OPN IRON MOUNTAIN)

1st MAW

MAG-12

MAG-13

- VMFA-115 (F-4B)
- VMFA-314 (F-4B)
- VMFA-122 (F-4B)
- VMA-311 (A-4E)

USMC 5,230
USN 116
USA 24,430

OKINAWA

HQ, I MEF
3D MARDIV (-) (REIN)(TF-79)
11th MEB (TF-79.1)

- 4TH MARINES
- 1/4
 - 2/4
 - 3/4

9TH MARINES
3/9

- MAG-36
- VMGR-152 (KC-130F)
 - VMO-6 (OV-10A/UH-1E)
 - HMH-462 (CH-53A)

3D FSR (3,456) (50)
MCB CAMP BUTLER/NON FMF (915) (25)
Non-Deployable Casuals (148)
SVN-Originated Patients (0)

USMC 19,200
USN 934
ACTUALS CHARGED AGAINST PROGRAM VIII AS OF 5 FEB 70. 18,580 424

USMC RVN RECAP

OSD PROGRAM IX CEILING EFFECTIVE 15 APR 70. 42,610 2,233
ACTUALS CHARGED AGAINST PROGRAM IX AS OF 22 FEB 70. 52,042 2,017
III MAF 51,733 2,017
SU#1 1ST ANGLICO (215) (12)
OTHER 309
MACV STAFF/MACV FIELD. (273)
NAVAVGRU/NAVY UNITS (36)

I CORPS RECAP

US MARINE CORPS (12 BNs) 51,733
US ARMY (25 BNs) 73,849
US NAVY 16,931
US AIR FORCE 8,194
ROKMC (4 BNs) 6,148
RVNAF (36 BNs) 153,895
ARVN/ABN (36 BNs) (74,634)
VNMC (2,100)
VNN (3,408)
VNAP (37,403)
VNRFP (36,350)
VNPF (36,350)

I CORPS TOTAL 77 BN 310,750

SLF 7TH FLEET

USMC USN
BRAVO: BLT 2/9 1,847 60
HMM-165
AT SUBIC
ALFA: BLT 1/9 1,868 85
HMM-164
AT OKINAWA

MOVEMENTS

Det 12th Mar and "D" Co, 3d Recon Bn. At Fuji for training.

JAPAN

USMC USN
OSD PROGRAM IX CEILING EFFECTIVE 15 APR 70. 4,700 45
ACTUALS CHARGED AGAINST PROGRAM VIII AS OF 5 FEB 70. 3,749 34

1ST MAW (REAR)

MAG-15 (2,553) (34)
VMFA-232 (F-4J)
VMFA-334 (F-4J)
VMA(AW)-533 (A-6A)
VMA-211 (A-4E)
(Less command)

*Does NOT include 243 hospitalized SVN-Originated Patients.

Non FMF (1,196)

* Includes only U. S. Navy Personnel organic to FMF Units.
Includes SU#1 and 1st ANGLICO at various locations throughout SVN.
• Latest Change

Unclassified

UNCLASSIFIED



MARINE CORPS

FEB 24 1970

REFERENCE BRANCH

Unclassified



SECRET
UNCLASSIFIED
SUMMARY OF MAJOR US AND FWMAF OPERATIONS

OPERATION (DATE COMMENCED)	UNITS INVOLVED	LOCATION	CASUALTIES AS OF 242400H FEB70		
			FRIENDLY		ENEMY
			KIA	WIA	KIA
GREENE RIVER (19JAN70)	1ST BDE, 5TH INF DIV (MECH): 4 USA BNS	EASTERN QUANG TRI PROVINCE	5	131	71
RANDOLPH GLEN (7DEC69)	101ST ABN DIV (AM): 9 USA BNS	QUANG TRI & THUA THIEN PROVINCES	65	290	449
VICTORY DRAGON XIX (1JAN70)	2D ROKMC BDE: 4 ROKMC BNS	HOI AN AREA	2	13	23
FREDERICK HILL (18MAR69)	196TH INF BDE: 3 USA BNS	QUANG TIN PROVINCE	389	2,414	4,577
GENEVA PARK (18JUL69)	198TH INF BDE: 2 USA BNS	QUANG TIN & QUANG NGAI PROVINCES	132	874	1,240
NANTUCKET BEACH (20JUL69)	198TH INF BDE: 1 USA BN	CENTERED 15 KM NE OF QUANG NGAI CITY	24	224	250
IRON MOUNTAIN (18MAR69)	11TH INF BDE: 5 USA BNS	QUANG NGAI PROVINCE	291	1,686	2,561

UNCLASSIFIED

• - ADJUSTED
 # - FINAL CUMULATIVE CASUALTIES

SECRET

FOR OFFICIAL USE ONLY
UNCLASSIFIED

MARINE CORPS COMMAND CENTER

USMC/ENEMY CASUALTIES IN RVN

24 FEBRUARY 1970

USMC BATTLE CASUALTIES

KIA/DOW	WIA(EVAC)	WIA(RTD)	MIA/PW
12,478	48,923	35,854	81/21

USMC CASUALTY FIGURES ARE PROVIDED DAILY BY HOMC CASUALTY SECTION (CODE DNA) AND REFLECT ALL CASUALTIES REPORTED AS OF 20 FEB 70.

USMC NON-BATTLE CASUALTIES

DEAD	INJURED	MISSING
1,514	1,822	13

FIGURES INDICATED AS INJURED ARE ONLY THOSE IN SERIOUS/CRITICAL INJURY OR DISEASE CATEGORY AND DO NOT INCLUDE THOSE OF A MINOR NATURE

USMC INFLECTED ENEMY CASUALTIES

KIA	PW	WPNS
80,837	4,206	20,822

ENEMY CASUALTIES ARE COMPILED DAILY FROM THE III MAF HISSUM AND ARE RECONCILED MONTHLY WITH THE FMFPAC SUMMARY OF USMC OPERATIONS IN RVN

TYPICAL DISPOSITION OF 100 USMC WIA *

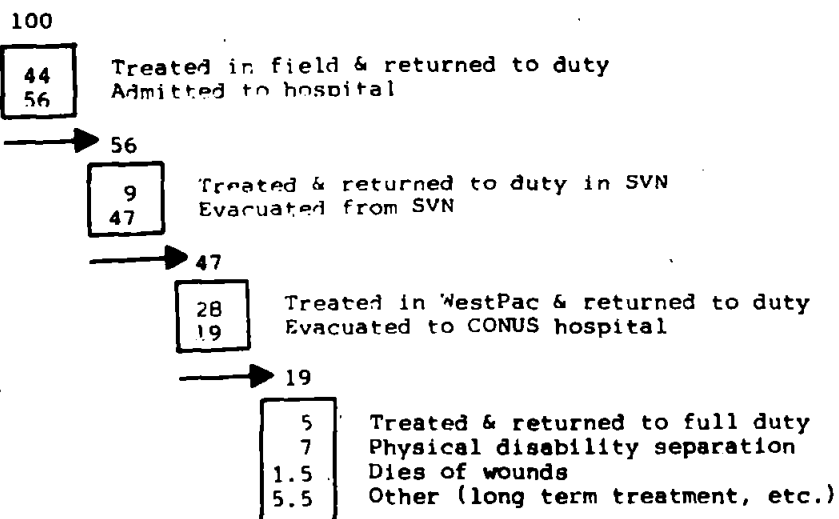

*54,081 CASUALTIES, JAN67-DEC68.

UNCLASSIFIED

UNCLASSIFIED
~~CONFIDENTIAL~~

24 FEBRUARY 1970

MARINE CORPS COMMAND CENTER

MILITARY FORCES IN RVN *

RVN ARMED FORCES (RVNAF)

ARMY (ARVN)	416,278
NAVY (VNN)	30,143
AIR FORCE (VNAF)	36,469
MARINE CORPS (VNMC)	11,528
REGIONAL FORCES (RF)	260,455
POPULAR FORCES (PF)	214,383
TOTAL RVNAF	969,256

UNITED STATES FORCES

ARMY	334,363
NAVY	29,017
AIR FORCE	56,106
MARINE CORPS	52,042
COAST GUARD	354
TOTAL U.S.	471,882

FREE WORLD MILITARY ASSISTANCE FORCES (FWMAF)

REPUBLIC OF KOREA	48,806
AUSTRALIA	7,593
PHILIPPINES	133
THAILAND	11,555
NEW ZEALAND	552
REPUBLIC OF CHINA	28
SPAIN	11
TOTAL FWMAF	68,691

TOTAL FORCES IN RVN 1,509,829

SOURCE: RVNAF MACV MONTHLY STRENGTH REPORT. ALL OTHER:
MACV WEEKLY STRENGTH REPORT AS OF 2400, 19FEB70.
USMC STRENGTH: MACV WEEKLY STRENGTH REPORT AS
ADJUSTED BY MACV RPT OF ARR/DEP AS OF 2400, 22FEB70.

UNCLASSIFIED
Unclassified
~~CONFIDENTIAL~~

UNCLASSIFIED

CHRONOLOGY OF SIGNIFICANT EVENTS

24 FEBRUARY 1970

DATES	LOCATION	UNITS	REMARKS
24NOV69	3 NM SE OF BU PRANG	1 ARVN BN	AN ARVN INF BN AND A CIDG BN DISCOVERED THE BODIES OF 119 ENEMY SOLDIERS KILLED BY AIR STRIKES ON OR ABOUT 19NOV69. FIVE MISSING CIDG MEMBERS BODIES AND ONE M-16 WERE RECOVERED.
NOV69	I CTZ		A RECORD NUMBER OF CHIEU HOI RETURNEE (813) RALLIED TO THE GVN EXCEEDING THE HIGHEST PREVIOUS MONTHLY TOTAL.
5DEC69	I CTZ		OPERATION KEYSTONE CARDINAL TERMINATED WITH 18,483 TROOPS, 23,813 SHORT TONS.
6DEC69	10 NM SW OF HUE	9 USA BNS	OPERATION REPUBLIC SQUARE TERMINATED. USA - 11 KIA, 66 WIA; ENEMY - 192 KIA, 144 IWC, 8 CS.
14DEC69	10 NM SSW OF DAU TIENG	1 USA CAV 1 RF	DISCOVERED AN ENEMY CACHE CONTAINING 2 TONS OF WEAPONS (323 INDIVIDUAL WEAPONS, 6 12.7MM HEAVY MACHINE GUN, 1 FLAME THROWER AND ASSORTED AMMO ROUNDS).
24-25DEC69	RVN		A TOTAL OF 115 TRUCE VIOLATIONS WERE REPORTED DURING THE U.S. AGREED CHRISTMAS TRUCE.
DEC69	I CTZ		THE CHIEU HOI CAMPAIGN PRODUCED 785 HOI CHANH DURING THE MONTH OF DECEMBER. THE SECOND HIGHEST MONTHLY TOTAL EVER RECEIVED IN ICTZ.
DEC69	I CTZ		THE 1969 CHIEU HOI CAMPAIGN NETTED 5,996 HOI CHANH, 2,570 VC GUERRILLAS, 148 NVA SOLDIERS AND 3,278 NON-MILITARY SUPPORTERS. BY FAR 1969 WAS THE MOST PRODUCTIVE YEAR SINCE THE PROGRAM COMMENCED IN 1963.

UNCLASSIFIED

Unclassified

UNCLASSIFIED

SELECTED UNIT COMMANDERS AND STAFF OFFICERS

24 FEBRUARY 1970

HEADQUARTERS FLEET MARINE FORCE ATLANTIC

COMMANDING GENERAL	LTGEN F. E. LEEK
DEPUTY COMMANDER	MGEN C. A. YOUNGDALE
CHIEF OF STAFF	COL J. E. LOPRETE
ACOS G-1	COL H. L. GIVENS, JR.
ACOS G-2	COL D. A. BREWSTER
ACOS G-3	COL J. C. VANCE
ACOS G-4	COL W. R. NOWADNICK

2D MARINE DIVISION			2D MARINE AIRCRAFT WING		
COMMANDING GENERAL	MGEN	M. P. RYAN	COMMANDING GENERAL	MGEN	M. E. CARL
ADC	BGEN	R. D. BOHN	AWC	COL	R. R. READ
CHIEF OF STAFF	COL	L. V. CORBETT	CHIEF OF STAFF	COL	W. D. WILCOX
ACOS G-1	COL	L. S. HOLLIER	ACOS G-1	COL	J. E. HANSEN
ACOS G-2	COL	R. M. PLATT	ACOS G-2	LTCOL	J. R. STANLEY
ACOS G-3	COL	E. Y. HOLT	ACOS G-3	COL	G. W. MORRISON
ACOS G-4	COL	R. J. LAHR	ACOS G-4	COL	J. L. HERNDON
2D MARINES			MWHG-2		
COMMANDING OFFICER	COL	BRADLEY	COMMANDING OFFICER	LTCOL	T. W. RIGGS
1ST BATTALION	LTCOL	W. E. MCKINSTRY	H&HS-2	LTCOL	J. T. HAGEN
2ND BATTALION	LTCOL	D. C. BINNEY	MWFS-2	MAJOR	D. T. SITES
3RD BATTALION	LTCOL	E. F. PIERSON, JR.	MWCS-2	MAJOR	F. SIMON
6TH MARINES			MMSG-27		
COMMANDING OFFICER	COL	P. B. HAIGWOOD	COMMANDING OFFICER	COL	R. M. WILLIAMS
1ST BATTALION	LTCOL	D. M. TWOMEY	H&HS-27	MAJOR	E. J. HEISE
2ND BATTALION	LTCOL	G. B. CRIST	WERS-27	LTCOL	S. W. WILLIAMS
3RD BATTALION	LTCOL	J. W. DUNCAN	VMGR-252	LTCOL	J. E. FEGLEY
8TH MARINES			MWCG-28		
COMMANDING OFFICER	LTCOL	J. R. GREENSTONE	COMMANDING OFFICER	LTCOL	J. M. JOHNSON
1ST BATTALION	MAJOR	JOHNSON	H&HS-28	MAJOR	L. H. SHAY
2ND BATTALION	LTCOL	C. W. ABBOTT	MASS-1	MAJOR	L. J. DRAAYER
3RD BATTALION	LTCOL	D. M. DUFFIELD	MACS-5	MAJOR	H. M. FIX
10TH MARINES			MAG-14		
COMMANDING OFFICER	COL	T. J. HOLT	COMMANDING OFFICER	COL	G. H. KELLER, JR.
1ST BATTALION	LTCOL	R. W. HEESCH	H&MS-14	LTCOL	J. D. DUNN
2ND BATTALION	MAJOR	C. A. AUSTIN	MABS-14	MAJOR	K. L. RATT
3RD BATTALION	LTCOL	D. E. COOMBE	VMCJ-2	LTCOL	H. C. PERKINS
4TH BATTALION	LTCOL	B. F. READ	VMA(AW)-224	LTCOL	F. G. DAWSON
HQ BN, 2ND MARDIV	COL	J. M. LANDRIGAN	VMA(AW)-121	LTCOL	E. E. JACOBSON, JR.
2ND SERVICE BATTALION	LTCOL	H. A. HATCH	VMA(AW)-332	LTCOL	R. R. VAN DALSEN
2ND AT BATTALION	MAJOR	C. R. BRABEC	VMFA-513	LTCOL	C. L. BATTISTONE
2ND MT BATTALION	LTCOL	W. S. GERICHTEN	MCCRTG-20		
2ND RECON BATTALION	LTCOL	J. T. SMITH	COMMANDING OFFICER	COL	C. H. LUDDEN
2ND ENGR BATTALION	LTCOL	G. B. CORNWALL	H&MS-20	LTCOL	R. C. BARRETT
2ND SP BATTALION	MAJOR	F. E. PAIGE	VMFAT-201	LTCOL	P. L. SIEGMUND
2ND MED BATTALION	CAPT (MC)	F. W. ARMINGTON	VMAT(AW)-202	LTCOL	T. R. MADDOCK
LANFORCARIB 1-70	LTCOL	E. F. PIERSON, JR.	VMT-203	LTCOL	F. P. WILLIAMS, JR.
LANFOR6THFLT 3-69	LTCOL	G. B. CRIST	MAG-26		
GTHODEPOR	LTCOL	C. W. ABBOTT	COMMANDING OFFICER	COL	J. A. NELSON
FORCE TROOPS FMFLANT			H&MS-26	MAJOR	J. S. EVANS
COMMANDING GENERAL	BGEN	J. C. FEGAN JR.	MABS-26	MAJOR	H. S. LOWREY, JR.
CHIEF OF STAFF	COL	D. A. CLEMENT	VMO-1	LTCOL	E. J. MURPHY
ACOS G-1	LTCOL	J. H. LANDERS	HMH-461	LTCOL	C. G. REDMAN
ACOS G-2	MAJOR	F. T. WHITMAN	HMM-162	LTCOL	J. A. ROBERTS
ACOS G-3	LTCOL	E. J. ROCHFORD	HMM-261	LTCOL	V. W. HAZELBAKER
ACOS G-4	LTCOL	J. B. CANTINEY	HMM-264	LTCOL	R. G. BUSTOS
2D FORCE SERVICE REGIMENT			HMM-365	LTCOL	R. H. NELSON
COMMANDING OFFICER	COL	C. H. SCHMID	HMH-362	LTCOL	M. J. NEEDHAM
H&S BATTALION	LTCOL	G. F. TUBLEY	MAG-31		
SUPPLY BATTALION	LTCOL	O. H. SAYCE	COMMANDING OFFICER	COL	V. J. PEEBLES
MAINT BATTALION	LTCOL	C. L. BOOTH	H&MS-31	LTCOL	R. L. MARTIN
2D TANK BATTALION	LTCOL	J. L. SAUL	MABS-31	LTCOL	R. J. WEISS
8TH COMM BATTALION	LTCOL	R. E. HAISLIP	VMA-331	MAJOR	J. V. SULLIVAN
8TH ENGR BATTALION	LTCOL	W. G. VIERS	VMFA-333	LTCOL	J. A. HERBER
8TH MT BATTALION	LTCOL	J. F. JONES	VMFA-451	LTCOL	C. U. GEBSEN
2D RADIO BATTALION	LTCOL	D. L. MITCHELL	MAG-32		
2D FLD ARTY GROUP	COL	C. S. KIRCHMANN	COMMANDING OFFICER	COL	H. V. HUFFSTUTTER
2D AMTRAC BATTALION	LTCOL	J. R. CATT	H&MS-32	MAJOR	L. F. GAGNON
2D ANGLICO	LTCOL	SCHUELER	MABS-32	MAJOR	M. A. YARNELL
4TH DENT CO	CAPT	HAGERMAN	VMFA-251	LTCOL	R. O. LAWRENCE
			VMFA-312	LTCOL	C. J. EVERSOLE
			VMA-324	LTCOL	G. M. LAWRENCE JR.
			MHTG-40		
			COMMANDING OFFICER	LTCOL	M. G. ROBBINS
			H&HS-40	MAJOR	J. T. GORDON
			HMHT-401	MAJOR	C. L. WHIPPLE
			HMMT-402	LTCOL	D. R. CARPENTER

UNCLASSIFIED

Unclassified

~~CONFIDENTIAL~~

MARINE CORPS COMMAND CENTER

SELECTED PERSONNEL AND AIRCRAFT DATA

UNCLASSIFIED

PERSONNEL

25 FEBRUARY 1970

	STRENGTH	PERCENT USMC	PERCENT FMF	PERCENT FMFPAC
USMC TOTAL	301,675 *	100.00		
FLEET MARINE FORCES	153,295	50.81	100.00	
FMF ATLANTIC	45,696 \$	15.14	29.81	
FMF PACIFIC	107,599 #	35.66	70.19	
VIETNAM	51,994 †	17.23	34.21	48.74

SOURCE: * MONTHLY USMC PERSONNEL ALLOCATION REPORT OF 31DEC69.
 \$ MCCC UNIT REPORT OF 12FEB70.
 # MCCC UNIT REPORT OF 4FEB70.
 † MACV WEEKLY STRENGTH REPORT AS OF 2400, 19FEB70 AS ADJUSTED BY THE MACV DAILY RPT OF ARR/DEP AS OF 2400, 23FEB70.

AIRCRAFT

25 FEBRUARY 1970

	FIXW	HELO	TOTAL	PERCENT USMC	PERCENT FMF	PERCENT FMFPAC
USMC TOTALS	1013	569	1582	100.00		
FLEET MARINE FORCES	756	563	1319	83.37	100.00	
FMF ATLANTIC	293	162	455	28.76	34.49	
FMF PACIFIC	463	401	864	54.61	65.50	
VIETNAM	156	168	324	20.48	24.56	37.50

SOURCE: MARINE CORPS COMMAND CENTER UNIT REPORT OF 18FEB70.

UNCLASSIFIED

~~CONFIDENTIAL~~

~~CONFIDENTIAL~~
UNCLASSIFIED

DISTRIBUTION OF PERSONNEL

FLEET MARINE FORCE, PACIFIC

25 FEBRUARY 1970

UNIT	NOTE	ASSIGNED STRENGTH		STR RPT DATE	DANANG		CHU LAI		PHU BAI		No I CTZ		OKINAWA		JAPAN		HAWAII		EASTPAC		OTHER	
		USMC	USN		USMC	USN	USMC	USN	USMC	USN	USMC	USN	USMC	USN	USMC	USN	USMC	USN	USMC	USN	USMC	USN
1ST BN, 13TH MARINES		1143	31		1143	31																
HO BTRY, 1ST FAG		294	9																294	9		
1ST 175MM GUN BTRY		151	3		151	3																
3D 175MM GUN BTRY		172	3		172	3																
5TH 175MM GUN BTRY		217	8								217	8										
7TH 155MM GUN BTRY		499	1																499	1		
1ST 8" HOW BTRY		207	5								207	5										
3D 8" HOW BTRY		216	5		216	5																
1ST SGT BTRY (CADRE)																						
RECONNAISSANCE																						
1ST RECON BN		740	53		740	53																
3D RECON BN		380	23										288	18					92	5		
1ST FORCE RECON CO		149	7		149	7																
3D FORCE RECON CO		152	7								152	7										
ANTI-TANK																						
1ST AT BN																						
3D AT BN	4																					
CO'A' 3D ATBN		94	7																94	7		
TANK																						
1ST TANK BN		708	21		708	21																
3D TANK BN		653	19										456	12					197	7		
AMTRAC																						
1ST AMTRAC BN		715	16										497	12					218	4		
3D AMTRAC BN		768	21		768	21																
1ST ARM AMPHIB CO		88																	88			
ENGINEER																						
1ST ENGR BN		790	17		790	17																
3D ENGR BN		656	17										501	16					155	1		
7TH ENGR BN		1054	24		1054	24																
9TH ENGR BN		1051	21					1051	21													
11TH ENGR BN		1014	14										439	12					575	2		
1ST BRIDGE CO		205	2		205	2																
3D BRIDGE CO (-)		141	1																141	1		
MOTOR TRANSPORT																						
1ST MT BN		392	7		392	7																
3D MT BN		258	10										182	9					76	1		
7TH MT BN		366	10																366	10		
9TH MT BN		470	11										311	10					159	1		
11TH MT BN		514	8		514	8																
COMMUNICATION																						
1ST RADIO BN		500	1		348								67					85	1			
5TH COMM BN		989	13		989	13																
7TH COMM BN (-)		365	9										365	9								
9TH COMM BN		1182	11																1182	11		
1ST ANGLICO	2	250	7															110	4			140 3
SHORE PARTY																						
1ST SP BN		513	20		513	20																
3D SP BN		514	28										381	12					133	16		
MILITARY POLICE																						
1ST MP BN		656	16		656	16																
3D MP BN		794	14		794	14																
SERVICE/SUPPORT																						
FLC, III MAF																						
HO, FLC/1ST FSR																						
H&S BN	7	2026	56		1375	56													651			
SUPPLY BN		1605	38		1605	38																
7TH SEP BK FUEL CO		242			242																	
MAINT BN		1150	12		1150	12																
FLSG-B/1ST SERV BN		2515	39		2515	39																
3D FSR																						
H&S BN		897	34										897	34								
SUPPLY BN		1078	22										1078	22								
MAINT BN		884											884									
5TH FSR																						
H&S BN		613	24																613	24		
SUPPLY BN		685	16																685	16		
MAINT BN		821																	821			
3D SERV BN (-)		1511	45										600	27					911	18		
9TH SEP BULK FUEL CO		356																	356			

Unclassified

~~CONFIDENTIAL~~
UNCLASSIFIED

UNCLASSIFIED

DISTRIBUTION OF PERSONNEL

FLEET MARINE FORCE, PACIFIC

25 FEBRUARY 1970

UNIT	NOTE	ASSIGNED STRENGTH		STR RPT DATE	DANANG		CHU LAI		PHU BAI		NO I CTZ		OKINAWA		JAPAN		HAWAII		EASTPAC		OTHER		
		USMC	USN		USMC	USN	USMC	USN	USMC	USN	USMC	USN	USMC	USN	USMC	USN	USMC	USN	USMC	USN	USMC	USN	USMC
MEDICAL																							
1ST MED BN		176	363		176	363																	
3D MED BN		171	247										93	194						78	53		
1ST HOSP CO		42	60		42	60																	
1ST DENTAL CO			66			66																	
3D DENTAL CO		3	81										3	81									
11TH DENTAL CO		4	74		4	74																	
13TH DENTAL CO			33																			33	
5TH DENTAL CO		3	42														00	00			3	42	
3D HOSP CO		36	63																	36	63		
	USMC	76,967			38,481	1,569	685	789	16,523	000			3,553	13,511	1,856								
	USN	3,441			1,824	21	7	13	889	000			109	524	54								
	GROUND TOTAL	80,408			40,305	1,590	692	802	17,412	000			3,662	14,035	1,910								

AVIATION UNITS

HQ SQDN FMFPAC		61																					
1ST MAW																							
MWHG-1																							
H&HS-1		793	37		793	37																	
MWFS-1		163			163																		
MWCS-1		225			225																		
MMSG-17																							
H&MS-17		735	20		735	20																	
WERS-17		248			248																		
MAG-18																							
H&HS-18		224	10		224	10																	
MASS-3		312	2		312	2																	
MACS-4		331	3		331	3																	
MAG-11																							
H&MS-11		626			626																		
MABS-11		540	27		540	27																	
VMCJ-1		329	1		329	1																	
VMA(AW)-225		197	1		197	1																	
VMA(AW)-242		207	1		207	1																	
VMO-2		143			143																		
MAG-12																							
H&MS-12		442			442																		
MABS-12		558	27		558	27																	
VMA-211		143	1		143	1																	
MAG-13																							
H&MS-13		455			455																		
MABS-13		525	34		525	34																	
VMA-115		240	1		240	1																	
VMA-314		243	1		243	1																	
VMA-122		246	1		246	1																	
MATCU-67		78			78																		
VMA-311		168	1		168	1																	
MAG-16																							
H&MS-16		468			468																		
MABS-16		937	28		937	28																	
MATCU-68		73			73																		
HML-167		250			250																		
HMM-364		211	1		211	1																	
HMH-463		186			186																		
HMM-263		199	1		199	1																	
HML-367		202	2		202	2																	
HMM-161		210			210																		
HMM-262		229	1		229	1																	
MCAF INAKUNI	B	1200												1200									
1ST MAW (REAR)																							
H&HS-1 (REAR)		417	5											417	5								
MAG-15																							
H&MS-15		565												565									
SU#2 NWS		54												54									
MABS-15		456	20											456	20								
MATCU-60		68												68									
VMA-232		276												276									
VMA-334		275	1											275	1								
VMA (AW)-533		224												224									
MASS-2		156												156									
MATCU-62		57												57									
MAG-18 (REAR)																							
H&S-18 (REAR)		61												61									
MCAF FUTEMA																							
MAG-36																							
H&MS-36		509												509									
MABS-36		496	10											496	10								
MATCU-66		48												48									
VMGR-152		411	5											411	5								
HMM-165		186	3																			186	3
HMM-164		189	5																				
HMH-462		189												189									
VMO-6		189	4											189	4								
MCSB-B		47	24											47	24								

Unclassified

UNCLASSIFIED

CONFIDENTIAL
UNCLASSIFIED

DISTRIBUTION OF PERSONNEL

FLEET MARINE FORCE, PACIFIC

25 FEBRUARY 1970

UNIT	NOTE	ASSIGNED STRENGTH		STRENGTH RPT DATE	DANANG		CHU LAI		PHU BAI		No 1 CTZ		OKINAWA		JAPAN		HAWAII		EASTPAC		OTHER		
		USMC	USN		USMC	USN	USMC	USN	USMC	USN	USMC	USN	USMC	USN	USMC	USN	USMC	USN	USMC	USN	USMC	USN	USMC
1ST BRIG																							
MAG-24																							
H&MS-24		455																455					
MABS-24		349	27															349	27				
MACS-2		200																200					
MATCU-70		40																40					
VMFA-212		278																278					
VMFA-235		266																266					
3D MAW																							
MWHG-3																							
H&MS-3		671	99																	671	99		
MWFS-3		174																		174			
MWCS-3		265																		265			
MCCRTG-10																							
H&MS-10		279	2																	279	2		
VMAT-102																							
VMAT-102		208																		208			
VMT-102																							
VMT-102		190																		190			
MHTG-30																							
H&MS-30		358	1																	358	1		
HMHT-301		164	1																	164	1		
HMHT-302		191	1																	191	1		
MAG-33																							
H&MS-33		926	1																	926	1		
MABS-33		533	3																	533	3		
MATCU-65		61																		61			
VMCU-3		371	1																	371	1		
VMA-223	7	166	1																	166	1		
VMA-214		218																		218			
VMFA-531		380	1																	380	1		
VMFA-542		269	1																	269	1		
VMFA-323 (CADRE)		12																		12			
VMPAT-101		511																		511			
MWSG-37																							
H&MS-37		663	3																	663	3		
WERS-37		308	1																	308	1		
VMGR-352		371	1																	371	1		
MAG-38																							
H&MS-38		312	2																	312	2		
MACS-1																							
MACS-1		301																		301			
MACS-3																							
MACS-3		269	4																	269	4		
MACS-7																							
MACS-7		284	1																	284	1		
1ST LAAM BN																							
1ST LAAM BN		144																		144			
2ND LAAM BN																							
2ND LAAM BN		764	18																	764	18		
MAG-56																							
H&MS-56		483																		483			
MABS-56		467	2																	467	2		
MATCU-74		81																		81			
HMM-163		255	1																	255	1		
HML-267		383	5																	383	5		
HMM-265		215	1																	215	1		
HMH-363		274																		274			
MATCU-75		48																		48			
HMH-361	7	185	1																	185	1		
USMC		30,998			8,068	3,098	0	0	2,434	3,809	1,649	11,754	186										
USN		458			135	66	0	0	48	27	27	152	3										
AVIATION TOTAL		31,456			8,203	3,164	0	0	2,482	3,836	1,676	11,906	189										

RECAPITULATION OF FMFPAC PERSONNEL DISTRIBUTION

		ASSIGNED STRENGTH	DANANG	CHU LAI	PHU BAI	No 1 CTZ	OKINAWA	JAPAN	HAWAII	EASTPAC	OTHER
GROUND TOTAL	USMC	76,967	38,481	1,569	685	789	16,523	0	3,553	13,511	1,856
	USN	3,441	1,824	21	7	13	889	0	109	524	54
AVIATION TOTAL	USMC	30,998	8,068	3,098	0	0	2,434	3,809	1,649	11,754	186
	USN	458	135	66	0	0	48	27	27	152	3
GRAND TOTAL	USMC	107,965	46,549	4,667	685	789	18,957	3,809	5,202	25,265	2,042
	USN	3,899	1,959	87	7	13	937	27	136	676	57

- NOTES:**
1. FIGURES IN "OTHER" ASSIGNED TO SLF'S.
 2. FIGURES IN "OTHER" ASSIGNED TO VARIOUS LOCATIONS IN RVN.
 3. PERSONNEL IN "OTHER" ARE ASSIGNED TO IT, IIT, SSC, CIT, RED EYE AND NUCLEAR ORINANCE PLATOONS.
 4. STRENGTH INCLUDED IN 1ST AND 3D TANK BATTALIONS.
 5. THE 559 PERSONNEL LISTED IN "OTHER" ARE HOSPITALIZED AT LOCATIONS OTHER THAN OKINAWA, BUT ARE CARRIED ON THE ROLLS OF CASUAL COMPANY, MCB, CAMP BUTLER.
 6. AT SUBIC
 7. ENROUTE EASTPAC.
 8. PERSONNEL ARE NON-FMF CARRIED FOR OSD PROGRAM STRENGTH TOTALS ONLY.
 - * UNLESS OTHERWISE NOTED, STRENGTHS AND LOCATION ARE THOSE REPORTED BY UNIT PERSONNEL STATUS REPORTS AND DO NOT REFLECT DAY-TO-DAY ADJUSTMENTS BETWEEN PERIODS.
 - ** UNLESS OTHERWISE NOTED STRENGTH REPORT DATE IS 12FEB70.

UNCLASSIFIED

SELECTED UNIT COMMANDERS AND STAFF OFFICERS

25 FEBRUARY 1970

UNCLASSIFIED

HEADQUARTERS FLEET MARINE FORCE PACIFIC

COMMANDING GENERAL	LTGEN H. W. BUSE, JR.
DEPUTY COMMANDER	MGEN P. J. FONTANA
CHIEF OF STAFF	BGEN L. H. WILSON
ACOS, G-1	COL F. S. WOOD
ACOS, G-2	COL J. F. MITCHELL
ACOS, G-3	COL R. M. HALL
ACOS, G-4	COL J. B. SOPER
ACOS, G-5	LTCOL E. L. HICKAM

5TH MARINE EXPEDITIONARY BRIGADE

COMMANDING GENERAL	BGEN R. T. DWYER, JR.
AIC	
CHIEF OF STAFF	COL M. W. SCHMIDT
ACOS, G-1	COL E. R. DAZE
ACOS, G-2	MAJOR J. D. LITTLE
ACOS, G-3	COL J. P. KELLY
ACOS, G-4	COL G. R. STURDIVAN
HQ BN	LTCOL J. F. HEL
H&SCO	MAJ J. A. LINNEMANN
3RD MARINES	
COMMANDING OFFICER	COL W. A. BUTCHER
2ND BATTALION	LTCOL E. Z. GRABOWSKI
3RD BATTALION	LTCOL J. G. COLLIER
1STBN, 12THMAR	
M BTRY, 4THBN, 12THMAR	LTCOL J. F. HELSEL
CoA, 3D AT BN	CAPT C. W. FATTIG
CoA, 3D RECON BN	CAPT R. E. FIELDS, JR.
CoB, 3D ENGR BN	CAPT A. A. LOPEZ
CoB, 3D MT BN	CAPT M. A. SELBY
Co B, 3D SP BN	MAJ B. E. MACHA
Co D, 3D TANK BN	CAPT W. J. NIBELLO
DET, 3D SERVICE BN	COL G. K. REID
COMM SPT CO, 9TH COMM BN	
Co B, 11TH ENGR BN	MAJ W. B. LUDWICK
Co B, 9TH MT BN	CAPT H. L. CAMPBELL
Co A, 1ST AMTRAC BN	CAPT C. D. GARRETT
1ST SEARCHLIGHT BTRY	MAJ R. G. JONES
9TH SEP BULK FUEL CO	CAPT K. C. KALBFLEISCH
3D BRIDGE CO	MAJ M. E. MC PHERSON
1ST ARMD AMPHIB CO	CAPT J. P. MEREDITH
1ST CIVIL AFFAIRS GROUP	MAJ R. D. DASCH
3D HOSP CO	COL R. M. TAYLOR
Co C, 3D MED BN	LT E. J. CARLISLE (USN)
DET#2, 5TH DENT CO	LT D. B. COOLIDGE (USN)
7TH MT BN	CAPT J. A. KOCH (USN)
	MAJOR L. E. DAVIES

1ST MARINE BRIGADE

COMMANDING OFFICER	COL B. G. CASS
S-1	LTCOL W. H. WAHFELD
S-2	CWO P. B. MURPHY
S-3	LTCOL J. R. W. COCHRAN
S-4	LTCOL E. L. CONROY
H&SCO	MAJ J. G. HANRAHAN
1ST BN, 3D MARINES	LTCOL D. J. HUNTER
MAG-24	
COMMANDING OFFICER	COL K. C. PALMER
H&MS-24	LTCOL W. H. HEINTZ
MARS-24	LTCOL A. B. COLBERT
MACS-2	LTCOL R. D. MILLER
VMFA-212	LTCOL H. H. ZIEGLER
VMFA-235	LTCOL L. A. MADERA
MATCU-70	MAJOR H. B. VERGARA
SU#2, 1ST RAD BN	MAJOR L. K. RUSSELL
DET#1, 5TH DENT CO	CDR J. D. CRAWFORD

FORCE TROOPS FMFPAC

COMMANDING GENERAL	BGEN C. W. HOFFMAN
ASSISTANT COMMANDER	COL A. B. CLARK
CHIEF OF STAFF	COL L. N. UTTER
ACOS, G-1	LTCOL D. K. GRAY
ACOS, G-2	1STLT R. COOK
ACOS, G-3	LTCOL W. R. MILLER, JR.
ACOS, G-4	LTCOL M. E. FARMER
3RD FORCE SERVICE REGT	
COMMANDING OFFICER	COL J. R. JONES
H&S BATTALION	LTCOL J. B. HARRIS
SUPPLY BATTALION	LTCOL H. G. FISCHER
MAINT BATTALION	LTCOL L. I. FEIN
5TH FORCE SERVICE REGT	
COMMANDING OFFICER	COL K. W. HENRY
H&S BATTALION	MAJOR J. A. SHEARMAN, JR.
SUPPLY BATTALION	LTCOL M. E. STEIN
MAINT BATTALION	LTCOL J. M. HERMES
13TH MT BATTALION	MAJOR T. M. COLLINS
9TH COMM BATTALION	LTCOL G. W. HOUCK

UNCLASSIFIED

SELECTED UNIT COMMANDERS AND STAFF OFFICERS

25 FEBRUARY 1970

UNCLASSIFIED

HEADQUARTERS III MARINE AMPHIBIOUS FORCE

COMMANDING GENERAL	LTGEN H. NICKERSON, JR.
DEPUTY COMMANDER	MGEN G. S. BOWMAN, JR.
CHIEF OF STAFF	BGEN L. J. DULACKI
DEPUTY CHIEF OF STAFF	COL S. A. DRESSIN
ACOS, G-1	COL R. L. PARNELL, JR.
ACOS, G-2	COL E. W. DZIALO
ACOS, G-3	BGEN T. H. MILLER, JR.
ACOS, G-4	COL W. F. SIMLIK
ACOS, G-5	COL C. J. PEABODY
ACOS, G-6	LTCOL R. S. BARRY
ACOS, COMPT	LTCOL J. M. VOSMIK
DEP C/S SPECIAL PROJECTS	COL A. T. WOOD

CG XXIV CTZ	LTGEN M. ZAIS USA
DEP C/S XXIV CTZ	COL M. M. COOK USMC

ACOS, CAP	COL T. E. METZGER
COMMANDING OFFICER, 1ST CAG	LTCOL D. F. SEILER
COMMANDING OFFICER, 2ND CAG	LTCOL D. R. CHRISTENSEN
COMMANDING OFFICER, 3RD CAG	LTCOL C. M. DANIELS
COMMANDING OFFICER, 4TH CAG	LTCOL J. J. KEENAN
1ST RADIO BATTALION	LTCOL D. M. HOPKINS

1ST MARINE DIVISION

COMMANDING GENERAL	MGEN E. B. WHEELER
AIC	BGEN W. F. DOEHLER
CHIEF OF STAFF	COL C. E. WALKER
ACOS, G-1	COL R. E. BARDE
ACOS, G-2	COL E. A. WILCOX
ACOS, G-3	COL F. H. WALDROP
ACOS, G-4	COL N. A. CANZONA
ACOS, G-5	COL L. S. HULLIER
ACOS, COMPT	LTCOL N. M. LASLAVIC, JR.
CEO	COL C. G. DAHL
1ST MARINES	
COMMANDING OFFICER	COL E. A. WILCOX
1ST BATTALION	LTCOL G. S. DELCUZE
2ND BATTALION	LTCOL W. V. H. WHITE
3RD BATTALION	LTCOL F. M. BOYD
5TH MARINES	
COMMANDING OFFICER	COL R. F. ESTEY
1ST BATTALION	LTCOL J. K. GRIFFIS, JR.
2ND BATTALION	LTCOL F. LEDER
3RD BATTALION	LTCOL J. S. GESTSON
7TH MARINES	
COMMANDING OFFICER	COL G. S. CODISPOTI
1ST MARINES	LTCOL C. G. COOPER
2ND MARINES	LTCOL A. E. FOLSOM
3RD MARINES	LTCOL R. G. KUMMEROW
26TH MARINES	
COMMANDING OFFICER	COL J. E. HARRELL
1ST BATTALION	LTCOL J. C. GOODIN
2ND BATTALION	LTCOL P. L. HUMPHREY
3RD BATTALION	LTCOL J. J. UNTERKOFLEK
11TH MARINES	
COMMANDING OFFICER	COL D. D. EZELL
1ST BATTALION	LTCOL J. D. SHOUP
2ND BATTALION	LTCOL V. WEAVER
3RD BATTALION	LTCOL K. N. MUELLER
4TH BATTALION	LTCOL J. F. BURKE, JR.
1ST BN, 13TH MAR	LTCOL D. H. STRAIN
HQS BATTALION	COL W. C. PATTON
1ST ENGR BATTALION	LTCOL N. F. GLOWICKI
1ST RECON BATTALION	LTCOL W. C. DRUMWRIGHT
1ST MT BATTALION	LTCOL M. S. SHIMANOFF
1ST SP BATTALION	COL R. F. ARMSTRONG
1ST MED BATTALION	CAPT(MC) J. W. LEA
1ST TK BATTALION	MAJOR J. I. LOUDER
3RD AMTRAC BATTALION	LTCOL D. G. MEHARGUE
7TH ENGR BATTALION	LTCOL W. G. BATES
9TH ENGR BATTALION	LTCOL E. K. MAXWELL
11TH MT BATTALION	LTCOL W. R. KEPHART

FORCE LOGISTICS COMMAND

COMMANDING GENERAL	BGEN M. J. PADALINO
CHIEF OF STAFF	COL J. L. TOBIN
ACOS, G-1	LTCOL J. E. REDELFS
ACOS, G-2	LTCOL R. L. SOLZE
ACOS, G-3	LTCOL W. W. STORM, III
ACOS, G-4	LTCOL M. H. IVINS
ACOS, G-5	MAJOR R. E. JOHNSON
ACOS, COMPT	LTCOL F. R. WARREN
CEO	MAJOR R. D. HAGAN
1ST FORCE SERVICE REGT	
H&S BATTALION	LTCOL L. R. WEBB
SUPPLY BATTALION	COL R. W. CALVERT
MAINT BATTALION	LTCOL E. C. MORRIS
FLSG-B/1ST SERV BN	COL D. E. MORIN
5TH COMM BATTALION (REIN)	LTCOL D. E. SHATZER
1ST MP BATTALION	LTCOL S. D. THOMAIDIS
3RD MP BATTALION	LTCOL C. FIMIAN

UNCLASSIFIED

CONFIDENTIAL
UNCLASSIFIED

DISTRIBUTION OF AIRCRAFT, FMFPAC

25 FEBRUARY 1970

	DANANG	CHO LAI	PHU BAI	OKINAWA	JAPAN	HAWAII	EASTPAC	OTHER
HO SQDN, FMFPAC						6/T-1A 1/C-54R 1/C-47J		
MAG-11 H&MS-11	8/TA-4F 1/C-117D							
VMCJ-1	7/RF-4B 11/EA-6A							
VMA(AW)-242	12/A-6A							
VMA(AW)-225	12/A-6A							
VMO-2	19/OV-10A							
MAG-12 H&MS-12								
VMA-211		14/A-4E						
MAG-13 H&MS-13		1/C-117D						
VMA-311		20/A-4E						
VMFA-115		15/F-4B						
VMFA-314		15/F-4B						
VMFA-122		13/F-4B						
MAG-15 H&MS-15						1/C-54Q 1/C-117D 3/TA-4F 1/C-54S		
VMFA-232						15/F-4J		
VMFA-334						12/F-4J		
VMA(AW)-533						13/A-6A		
MAG-16 H&MS-16	2/C-117D 1/CH-46A							
HML-167	42/UH-1E							
HML-367	24/AH-1G							
HMM-263	20/CH-46D							
HMM-161	21/CH-46D							
HMM-262	19/CH-46D							
HMM-364	21/CH-46D							
HMH-463	20/CH-53A/D							
MCCRTG-10 H&MS-10								
VMAT-102							26/A-4C	
VMT-103							16/TA-4F	
MWSG-17 H&MS-17	3/US-2B 3/C-117D							
MHTG-30 H&MS-30							5/CH-46D	
HMHT-301							10/CH-53A	
HMMT-302							19/CH-46D	
MAG-33 H&MS-33							4/F-4B 6/TA-4F	
VMA-223							20/A-4E	
VMCJ-3							9/RF-4B 12/EF-10B 13/A-4C	
VMA-214							15/F-4B	
VMFA-323 (CADRE)							18/F-4B	
VMFA-531							15/F-4B	
VMFAT-101							18/F-4B	
VMFA-542							15/F-4B	
MAG-36 H&MS-36								
VMGR-152						1/C-117D 2/UH-34D 9/CH-46A/D 12/KC-130E		
HMM-165								18/CH-46AD *
HMM-164								17/CH-46A *
HMR-462						14/CH53A		
VMO-6						10/UH-1E 18/OV-10A		

NOTES: * ASSIGNED TO SLF's
** ENROUTE CONUS

UNCLASSIFIED
Unclassified

MARINE CORPS COMMAND CENTER

~~CONFIDENTIAL~~

UNCLASSIFIED DISTRIBUTION OF AIRCRAFT, FMFPAC

25 FEBRUARY 1970

UNIT	DAWANG	CHO LAI	PRD BAI	OKINAWA	JAPAN	HAWAII	EASTPAC	OTHER
MWSG-37 H&MS-37							2/C-47J 3/C-54R/P/P 2/C-117D 1/C-47H	
VMGR-352							12/KC-130F	
MAG-56 H&MS-56							3/CH-46D 11/CH-53A 1/UH-1E	
HMH-361							19/CH-46A 14/CH-53A	
HML-267							7/OV-10A 18/UH-1E	
HMM-163							21/CH-46F	
HMH-363							20/CH-53A	
HMM-265							17/CH-46D	
MABS-56							1/CH-53A	
1ST MARINE BRIGADE MAG-24 H&MS-24						1/C-117D 4/UH-34D 3/TA-4F		
VMFA-212						15/F-4J		
VMFA-235						12/F-4J		
TOTAL FMFPAC ACFT								
FIXED WING (463)	78	78		31	46	39	191	
HELICOPTERS (401)	168			35		4	159	35

UNCLASSIFIED

NOTE: * ASSIGNED TO SLP's
** ENROUTE CONUS

~~CONFIDENTIAL~~

~~SECRET~~

UNCLASSIFIED

MARINE CORPS COMMAND CENTER
MARINE CORPS PERSONNEL IN RVN

25 FEBRUARY 1970

	OFF	ENL	TOTAL
* III MAF.	3,421	48,264	51,685
DANANG	(2,990)	(41,867)	(44,857)
CHU LAI	(376)	(4,854)	(5,230)
PHU BAI	(21)	(860)	(881)
DONG HA	(34)	(683)	(717)
SU #1, 1ST ANGLICO (AT VARIOUS LOCATIONS SVN)	((21))	((194))	((215))
OTHER USMC PERSONNEL	159	150	309
MACV STAFF/MACV FIELD	(136)	(137)	(273)
NAVADVGRU/NAVY UNITS	(23)	(13)	(36)
USMC IN RVN CHARGED AGAINST PROGRAM IX	3,580	48,414	51,994
U. S. NAVY, III MAF.	255	1,762	2,017

* AS REPORTED BY III MAF DAILY ADMIN SITREP # 49 AS OF 2400, 17FEB70 AND THE MACV WEEKLY STRENGTH REPORT, AS OF 2400, 23FEB70, AS ADJUSTED BY MACV DAILY RPT OF ARR/DEP AS OF 2400, 23FEB70.

UNCLASSIFIED

~~SECRET~~

**MARINE CORPS COMMAND CENTER
WESTPAC UNIT LOCATIONS**

25 FEBRUARY 1970

QUANG TRI
(QUANG TRI)

USMC 717
USN 36 *
USA 8,807

- 1ST BDE, 5TH INF DIV (MECH)
1/77 ARMOR (OPN GREENE RIVER)
1/61 INF (MECH) (OPN GREENE RIVER)
1/11 INF (OPN GREENE RIVER)
3/5 ARMD CAV SQDN (OPN GREENE RIVER)

THUA THIEN

HO, XXIV CORPS (PHU BAI)
HO, 101st ABN DIV (AM)

USMC 881
USN 46 *
USA 23,265

- 1ST BDE, 101ST ABN DIV (AM)
1/327 INF (AM) (OPN RANDOLPH GLEN)
2/327 INF (AM) (OPN RANDOLPH GLEN)
2/502 INF (AM) (OPN RANDOLPH GLEN)

2D BDE, 101ST ABN DIV (AM)
1/501 INF (AM) (OPN RANDOLPH GLEN)
2/501 INF (AM) (OPN RANDOLPH GLEN)
1/502 INF (AM) (OPN RANDOLPH GLEN)

3D BDE, 101ST ABN DIV (AM)
1/506 INF (AM) (OPN RANDOLPH GLEN)
2/506 INF (AM) (OPN RANDOLPH GLEN)
3/187 INF (AM) (OPN RANDOLPH GLEN)

QUANG NAM

HOS 1ST MAR DIV (DANANG)

HOS, III MAF

USMC 44,857
USN 1,803 *
USA 1,104
ROKMC 6,115 •

- 1ST MARINES
1/1
2/1
3/1

HO 1st MAW
MAG-11

- 5TH MARINES
1/5
2/5
3/5

- VMA(AW)-242 (A-6A)
VMA(AW)-225 (A-6A)
VMCJ-1 (RF-4/EA-6/EF-10)
VMO-2 (OV-10A)

- 7TH MARINES
1/7
2/7
3/7

- MAG-16
HML-367 (AH-1G)
HML-167 (UH-1E)
HMH-463 (CH-53A)
HMM-364 (CH-46D)
HMM-263 (CH-46D)
HMM-262 (CH-46D)
HMM-161 (CH-46D)

- 26TH MARINES
1/26
2/26
3/26

2d ROKMC BDE

- 1/2 (OPN VICTORY DRAGON XIX)
2/2 (OPN VICTORY DRAGON XIX)
3/2 (OPN VICTORY DRAGON XIX)
5/2 (OPN VICTORY DRAGON XIX)

FLC 1ST FSR/FLSG-B/1ST SERV BN

QUANG TIN/QUANG NGAI

HO 23d INF DIV (AMERICAL) (CHU LAI)

USMC 5,230
USN 116 *
USA 24,430

- 196TH LT INF BDE
2/1 INF (OPN FREDERICK HILL)
4/31 INF (OPN FREDERICK HILL)
3/21 INF (OPN FREDERICK HILL)
1/46 INF

1st MAW
MAG-12

- 198TH LT INF BDE
1/6 INF (OPN GENEVA PARK)
1/52 INF (OPN GENEVA PARK)
5/46 INF (OPN NANTUCKET BEACH)

- MAG-13
VMFA-115 (F-4B)
VMFA-314 (F-4B)
VMFA-122 (F-4B)
VMA-311 (A-4E)

- 11TH INF BDE
1/20 INF (OPN IRON MOUNTAIN)
4/21 INF (OPN IRON MOUNTAIN)
3/1 INF (OPN IRON MOUNTAIN)
4/3 INF (OPN IRON MOUNTAIN)
1/1 ARMD CAV SQDN (OPN IRON MOUNTAIN)

OKINAWA

HQ, I MEF
3D MAR DIV (-) (REIN)(TF-79)
11th MEB (TF-79.1)

OSD PROGRAM VIII CEILING 19,200 934
ACTUALS CHARGED AGAINST PROGRAM VIII AS OF 5FEB70. 18,580 424

- 4TH MARINES 1/4
2/4
3/4

9TH MARINES 3/9

- MAG-36 (14,061) (349)
VMGR-152 (KC-130F)
VMO-6 (OV-10A/UH-1E)
HMH-462 (CH-53A)

- 3D FSR (3,456) (50)
MCB CAMP BUTLER/NON FMF (915) (25)
Non-Deployable Casuals (148)
SVN-Originated Patients (0)

USMC RVN RECAP

	USMC	USN
OSD PROGRAM IX CEILING EFFECTIVE 15APR70.	42,610	2,233
ACTUALS CHARGED AGAINST PROGRAM IX AS OF 22FEB70.	51,994 •	2,017
III MAF	51,685 •	2,017
SU#1 1ST ANGLICO	(215)	(12)
OTHER	309	
MACV STAFF/MACV FIELD.	(273)	
NAVAVMGRU/NAVY UNITS	(36)	

I CORPS RECAP

US MARINE CORPS	(12 BNs)	51,685 •
US ARMY	(25 BNs)	73,849
US NAVY		16,931
US AIR FORCE		8,194
ROKMC	(4 BNs)	6,115 •
RVNAF	(36 BNs)	153,895
ARVN/ABN	(36 BNs)	(74,634)
VNMC		(2,100)
VNN		(3,408)
VNAF		(37,403)
VNRF		(36,350)
VNPF		
I CORPS TOTAL	77 BN	310,669 •

SLF 7TH FLEET

	USMC	USN
BRAVO: BLT 2/9	1,847	60
HMM-165		
AT SUBIC		
ALFA: BLT 1/9	1,868	85
HMM-164		
AT OKINAWA		

MOVEMENTS

Det 12th Mar and "D" Co, 3d Recon Bn, At Fuji for training.

JAPAN

	USMC	USN
OSD PROGRAM IX CEILING EFFECTIVE 15APR70.	4,700	45
ACTUALS CHARGED AGAINST PROGRAM VIII AS OF 5FEB70.	3,749	34
1ST MAW (REAR)		
MAG-15	(2,553)	(34)
VMFA-232 (F-4J)		
VMFA-334 (F-4J)		
VMA(AW)-533 (A-6A)		
VMA-211 (A-4E)		
(Less command)		

*Does NOT include 243 hospitalized SVN-Originated Patients.

Non FMF (1,196)

* Includes only U. S. Navy Personnel organic to FMF Units.
Includes SU#1 and 1st ANGLICO at various locations throughout SVN.
• Latest Change

Unclassified
UNCLASSIFIED

MARINE CORPS

FEB 25 1970

REFERENCE BRANCH

MARINE CORPS

FEB 25 1970

REFERENCE BRANCH

Unclassified

UNCLASSIFIED

SUMMARY OF MAJOR RVNAF OPERATIONS

OPERATION (DATE COMMENCED)	UNITS INVOLVED	LOCATION	CASUALTIES AS OF : 252400H FEB70		
			FRIENDLY		ENEMY
			KIA	WIA	KIA
LAM SON 350 (1JAN70)	2ND REGT: 1/2, 2/2, 3/2, 4/2 & 5/2	5 KM E OF GIO LINH	17	23	175
LAM SON 353 (1JAN70)	7TH CAV: 3/7 CAV	5 KM SE OF GIO LINH	4	25	28
LAM SON 354 (6JAN70)	54TH REGT: 3/54	6 KM S OF QUANG TRI CITY	1	2	1
LAM SON 352 (1JAN70)	54TH REGT: 1/54, 2/54 & 4/54	2 KM NW OF PHU BAI	1	6	29
LAM SON 349 (1JAN70)	1ST REGT: 1/1, 2/1, 3/1 & 4/1	21 KM NW OF A LUOI	12	46	172
LAM SON 351 (1JAN70)	3RD REGT: 1/3, 2/3, 3/3 & 4/3	25 KM SW OF HUE	5	13	49
HUNG QUANG 1/22 (12JAN70)	51ST REGT: 2/51 & 4/51	16 KM NW OF HOI AN	1	14	3
HUNG QUANG 1/25 (19FEB70)	51ST REGT: 1/51 & 3/51	5 KM NNW OF AN HOA	3	3	29
QUYET THANG 54 (2JAN70)	5TH REGT: 1/5, 2/5, 3/5, 4/5 & 4/6	12 KM W OF TAM KY	22	51	193
DUONG SON 3/70 (11FEB70)	1ST ARM BDE: 37TH & 39TH RGR BNS & 2/17 & 3/17 ACAT	30 KM NW OF TAM KY	36	92	356
QUYET THANG 63 (2JAN70)	6TH REGT: 1/6 & 3/6	18 KM NW OF QUANG NGAI CITY	19	106	119
QUYET THANG 45 (4JAN70)	4TH REGT: 1/4, 2/4, 3/4 & 4/4	11 KM SW OF DUC PHO	21	63	271

ALL UNITS ARE ARVN UNLESS DESIGNATED

• - ADJUSTED

- FINAL CUMULATIVE CASUALTIES

UNCLASSIFIED

Unclassified

UNCLASSIFIED

SUMMARY OF MAJOR US AND FWMAF OPERATIONS

OPERATION (DATE COMMENCED)	UNITS INVOLVED	LOCATION	CASUALTIES AS OF: 252400H FEB70		
			FRIENDLY		ENEMY
			KIA	WIA	KIA
GREENE RIVER (19JAN70)	1ST BDE, 5TH INF DIV (MECH): 4 USA BNS	EASTERN QUANG TRI PROVINCE	5	131	71
RANDOLPH GLEN (7DEC69)	101ST ABN DIV (AM): 9 USA BNS	QUANG TRI & THUA THIEN PROVINCES	66	301	461
VICTORY DRAGON XIX (1JAN70)	2D ROKMC BDE: 4 ROKMC BNS	HOI AN AREA	2	13	23
FREDERICK HILL (18MAR69)	196TH INF BDE: 3 USA BNS	QUANG TIN PROVINCE	389	2,415	4,579
GENEVA PARK (18JUL69)	198TH INF BDE: 2 USA BNS	QUANG TIN & QUANG NGAI PROVINCES	132	874	1,245
NANTUCKET BEACH (20JUL69)	198TH INF BDE: 1 USA BN	CENTERED 15 KM NE OF QUANG NGAI CITY	24	224	250
IRON MOUNTAIN (12MAR69)	11TH INF BDE: 5 USA BNS	QUANG NGAI PROVINCE	291	1,688	2,561

• - ADJUSTED
- FINAL CUMULATIVE CASUALTIES

UNCLASSIFIED

Unclassified

25 FEBRUARY 1970

Department of Defense

NUMBER OF CASUALTIES INCURRED BY U. S. MILITARY PERSONNEL
IN CONNECTION WITH THE CONFLICT IN VIET-NAM

Cumulative from January 1, 1961 through February 14, 1970

	Army	Navy **	Marine Corps	Air Force	Total
A. CASUALTIES RESULTING FROM ACTIONS BY HOSTILE FORCES					
1. Killed	21,664	979	11,103	401	34,147
2. Wounded or Injured					
a. Died of wounds	2,943	130	1,356	38	4,467
b. Nonfatal wounds					
Hospital care required	81,766	3,644	48,861	669	134,940
Hospital care not required	89,031	5,285	35,828	2,090	132,234
3. Missing					
a. Died while missing	1,417	176	5	333	1,931
b. Returned to control	56	7	6	25	94
c. Current missing	189	112	80	545	926
4. Captured or Interned					
a. Died while captured or interned	13	-	3	1	17
b. Returned to control	37	3	4	6	50
c. Current captured or interned	54	142	21	214	431
5. Deaths					
a. From aircraft accidents/incidents					
Fixed Wing	73	154	132	604	963
Helicopter	1,486	54	370	41	1,951
b. From ground action	24,478	1,077	11,965	128	37,648
TOTAL DEATHS <u>a/</u>	26,037	1,285	12,467	773	40,562
B. CASUALTIES NOT THE RESULT OF ACTIONS BY HOSTILE FORCES					
6. Current Missing	115	-	12	-	127
7. Deaths					
a. From aircraft accidents/incidents					
Fixed Wing	218	123	44	225	610
Helicopter	1,263	31	217	8	1,519
b. From other causes	3,335	540	1,244	210	5,329
TOTAL DEATHS	4,816	694	1,505	443	7,458

a/ Sum of lines 1, 2a, 3a and 4a.

**Navy figures include a small number of
Coast Guard casualties.Directorate for Statistical Services
Office of the Secretary of Defense
February 18, 1970

Unclassified

UNCLASSIFIED

MARINE CORPS COMMAND CENTER

USMC/ENEMY CASUALTIES IN RVN

25 FEBRUARY 1970

USMC BATTLE CASUALTIES

KIA/DOW	WIA(EVAC)	WIA(RTD)	MIA/PW
12,491	48,961	35,863	81/21

USMC CASUALTY FIGURES ARE PROVIDED DAILY BY HQMC CASUALTY SECTION (CODE DNA) AND REFLECT ALL CASUALTIES REPORTED AS OF 23FEB70.

USMC NON-BATTLE CASUALTIES

DEAD	INJURED	MISSING
1,515	1,823	13

FIGURES INDICATED AS INJURED ARE ONLY THOSE IN SERIOUS/CRITICAL INJURY OR DISEASE CATEGORY AND DO NOT INCLUDE THOSE OF A MINOR NATURE

USMC INFLECTED ENEMY CASUALTIES

KIA	PW	WPNS
80,863	4,206	20,825

ENEMY CASUALTIES ARE COMPILED DAILY FROM THE III MAF HISSUM AND ARE RECONCILED MONTHLY WITH THE FMPAC SUMMARY OF USMC OPERATIONS IN RVN

TYPICAL DISPOSITION OF 100 USMC WIA *

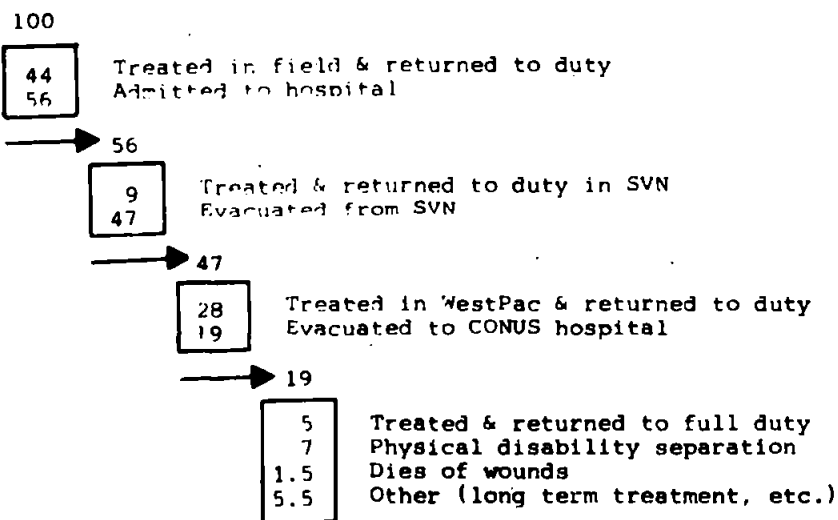

*54,081 CASUALTIES, JAN67-DEC68.

UNCLASSIFIED

UNCLASSIFIED

25 FEBRUARY 1970

CONFIDENTIAL

MARINE CORPS COMMAND CENTER

MILITARY FORCES IN RVN *

RVN ARMED FORCES (RVNAF)

ARMY (ARVN)	416,278
NAVY (VNN)	30,143
AIR FORCE (VNAF)	36,469
MARINE CORPS (VNMC)	11,528
REGIONAL FORCES (RF)	260,455
POPULAR FORCES (PF)	214,383
TOTAL RVNAF	969,256

UNITED STATES FORCES

ARMY	334,363
NAVY	29,017
AIR FORCE	56,106
MARINE CORPS	51,994
COAST GUARD	354
TOTAL U.S.	471,834

FREE WORLD MILITARY ASSISTANCE FORCES (FWMAF)

REPUBLIC OF KOREA	48,806
AUSTRALIA	7,593
PHILIPPINES	133
THAILAND	11,555
NEW ZEALAND	552
REPUBLIC OF CHINA	28
SPAIN	11
TOTAL FWMAF	68,691

TOTAL FORCES IN RVN 1,509,781

SOURCE: RVNAF MACV MONTHLY STRENGTH REPORT. ALL OTHER:
MACV WEEKLY STRENGTH REPORT AS OF 2400, 19FEB70.
USMC STRENGTH: MACV WEEKLY STRENGTH REPORT AS
ADJUSTED BY MACV RPT OF ARR/DEP AS OF 2400, 23FEB70.

UNCLASSIFIED
Unclassified

CINCPAC
VIETNAM & THAILAND - AIR FORCE

~~UNCLASSIFIED~~
UNCLASSIFIED

VIETNAM AIR FORCE

BAN ME THOUT

UH-1 8

BIEN HOA

F-100 21

A-37 61

O-1 58

O-2 86

OV-10 43

UC-123 13

C-7 1

C-47 2

HH-43 2

CAM RANH BAY

F-4 30

C-7 27

C-130 41

HH-43 2

O-1 22

O-2 68

RC-130 4

DA NANG

F-4 49

O-2 83

OV-10 37

HH-3 13

HH-43 2

C-47 1

A-1 10

AC-119 6

NHA TRANG

C-123 4

C-130 3

PHAN RANG

F-100 72

C-123 44

HH-43 2

HC-47 1

AC-119 13

PHU CAT

EC-47 13

C-7 26

F-4 34

HH-43 1

AC-119 5

PLEIKU

EC-47 13

TAN SON NHUT

RF-4 29

C-123 16

RB-57 4

RF-101 16

C-130 13

HH-43 2

EC-47 17

AC-119 5

TUY HOA

F-100 84

HC-130 11

HH-43 1

C-47 2

O-2 13

AC-119 5

UH-1 3

VUNG TAU

C-7 31

THAILAND AIR FORCE

BANGKOK

F-102 4

C-130 6

KORAT

F-4 32

HH-43 2

EC-121 26

C-121 1

NAKHOM PHANOM

UC-123 3

C-123 6

A-1 61

O-2 12

OV-10 20

HH-3 4

CH-3 6

EC-47 6

HH-43 2

TAKHLI

F-105 67

EB-66 16

HH-43 2

UBON

F-4 78

C-130 8

HH-43 3

AC-130 7

OV-10 10

AC-123 2

UDORN

RF-4 36

AC-47 3

F-4 34

HH-43 3

HH-53 9

C-130 6

CH-3 4

U-TAPAO

HH-43 2

27-1

~~UNCLASSIFIED~~

Unclassified

UNCLASSIFIED

DISTRIBUTION OF AIRCRAFT, FMFLANT

25 FEBRUARY 1970

UNIT	CHPT	BEAU	NEW RIVER	ROOS RD	MED	CARIB	NORFOLK	OTHER
HQ SQDN, FMFLANT							3/US-2B 2/T-1A 1/C-131 1/UH-34D 1/C-54S	
MAG-14	3/TA-4F							
H&MS-14	1/C-47J							
VMCJ-2	1/C-117D							
	8/RF-4B							
	14/EA-6A							
VMA(AW)-224	14/A-6A							
VMA(AW)-121	13/A-6A							
VMA(AW)-332	13/A-6A							
VMFA-513	17/F-4B							
MCCRTG-20								
H&MS-20								
VMFAT-201	25/F-4B/J							
VMAT(AW)-202	19/A-6A							
	3/TC-4C							
VMT-203	22/TA-4F							
MAG-26								
H&MS-26			1/C-117D					
VMO-1			1/C-47H					
			11/UH-1E			2/UH-1E		
HMM-162			17/OV-10A					
			24/CH-46F					
HMM-264			19/CH-46D					
HMM-365			32/CH-46F					
HMH-362			20/CH-53D					
HMH-461			20/CH-53A					
HMM-261								
MABG-26			1/C-117D			16/CH-46D		
MHTG-40								
H&MS-40								
HMHT-401								
HMHT-402			16/CH-46D					
MWSG-27								
H&MS-27	3/C-117D							
	2/C-54S							
	3/TA-4F							
VMGR-252	10/KC-130							
MAG-31								
H&MS-31		3/TA-4F						
		1/C-117D						
VMFA-333		11/F-4J						
VMA-331		20/A-4E						
VMFA-451		8/F-4J						
MAG-32								
		3/TA-4F						
		1/CH-47H						
H&MS-32		1/C-117D						
VMFA-251		13/F-4B						
VMFA-312		14/F-4B						
VMA-324		21/A-4C/E						
TOTAL LANT A/C								
FIXED WING (293)	171	95	20				7	
HELICOPTER (162)		1	142			18	1	

*AT YUMA FOR TRNG

DISTRIBUTION OF MAJOR GROUND EQUIPMENT

EQUIPMENT	T/E AUTH	CAM LEJ	VIEQUES	GTMO	CARIB	MED	OTHER
81mm MORTAR M29	72	48		8	8	8	
106mm RR M40A1C	72	48		8	8	8	
107mm MORTAR M30	18	18					
105mm HOW TD M101A1	54	36			6	6	
155mm HOW TD M114A1				6			
155mm GUN SP M53	6	6					
155mm HOW SP M109	18	18					
81n HOW SP M110	6	6					
90mm GUN TANK M4BA3	36	26			5	5	
120mm GUN TANK M103A2	17	17		5			
FLAME TANK M67A2	9	9					
HAWK LAUNCHERS	18						18*
ONTOS M50A1	45	24			5	5	
LVTP-5	156	112	24		10	10	

*CHERRY POINT

UNCLASSIFIED

~~CONFIDENTIAL~~

MARINE CORPS COMMAND CENTER

UNCLASSIFIED

SELECTED PERSONNEL AND AIRCRAFT DATA

PERSONNEL

26 FEBRUARY 1970

	STRENGTH	PERCENT USMC	PERCENT FMF	PERCENT FMPAC
USMC TOTAL	301,675 *	100.00		
FLEET MARINE FORCES	153,295	50.81	100.00	
FMF ATLANTIC	45,696 \$	15.14	29.81	
FMF PACIFIC	107,599 #	35.66	70.19	
VIETNAM	51,864 †	17.23	34.21	48.74

SOURCE: * MONTHLY USMC PERSONNEL ALLOCATION REPORT OF 31DEC69.
 \$ MCCC UNIT REPORT OF 12FEB70.
 # MCCC UNIT REPORT OF 4FEB70.
 † MACV WEEKLY STRENGTH REPORT AS OF 2400, 19FEB70 AS ADJUSTED BY THE MACV DAILY RPT OF ARR/DEP AS OF 2400, 24FEB70.

AIRCRAFT

25 FEBRUARY 1970

	FIXW	HELO	TOTAL	PERCENT USMC	PERCENT FMF	PERCENT FMPAC
USMC TOTALS	1013	569	1582	100.00		
FLEET MARINE FORCES	756	563	1319	83.37	100.00	
FMF ATLANTIC	293	162	455	28.76	34.49	
FMF PACIFIC	463	401	864	54.61	65.50	
VIETNAM	156	168	324	20.48	24.56	37.50

SOURCE: MARINE CORPS COMMAND CENTER UNIT REPORT OF 18FEB70.

UNCLASSIFIED

~~CONFIDENTIAL~~

CONFIDENTIAL
UNCLASSIFIED

MARINE CORPS COMMAND CENTER

FLEET MARINE FORCE DEPLOYMENTS

26 FEBRUARY 1970



1ST MAR BRIG
HAWAII

10TH MARINES
DET, 2D FAG
DET 1, HMM-254
AT VIEQUES FOR FIREX.
ETD 25MAR70 FOR
CAMLEJ.

GITMO AUGMENT
2D BN, 8TH MAR
BTRY B/1/10
PLT, 2D TK BN
PLT, 2D ANGLICO
DET, FSR

LANFORCARIB 1-70
BLT 3/2 & HMM-261
ENR GITMO
ETA 27FEB70

LANFORGTHELT 3-69
AT ATHENS

III MAF
RVN

SLF, 7TH FLEET
SLF ALFA
AT OKINAWA
SLF BRAVO
AT SUBIC

I MEF
OKINAWA
& JAPAN
DET, 12THMAR; "D" CO,
3D RECON BN AT FUJI
FOR TRNG.

DISTRIBUTION OF MAJOR FMF UNITS

	INF BNS	VMFA	VMA	VMA(AW)	VMCJ	BMM	BMB	BML	VMO	VMGR
WESTPAC	18	5	2	3	1	6	2	2	2	1
RVN	(12)	(3)	(1)	(2)	(1)	(4)	(1)	(2)	(2)	
OKINAWA/JAPAN	(4)	(2)	(1)*	(1)			(1)		(1)	(1)
ASSIGNED TO SLF'S	(2)					(2)				
MIDPAC	1	2								
HAWAII AFLOAT	(1)	(2)								
EASTPAC	2	**3	2		1	2	2	1		1
WEST COAST AFLOAT	(2)	(3)	(2)		(1)	(2)	(2)	(1)		(1)
ATLANTIC	8	5	2	3	1	4	2		1	1
EAST COAST	(6)	(5)	(2)	(3)	(1)	(3)	(2)		(1)	(1)
CARIBBEAN	(2)					(1)				
EUROPE	1									
MEDITERRANEAN	(1)									
GRAND TOTAL	30	15	6	6	3	12	6	3	3	3

* ENROUTE IWAKUNI.
** VMFA-323 IN CAIRE STATUS.

UNCLASSIFIED
UNCLASSIFIED

UNCLASSIFIED

MARINE CORPS COMMAND CENTER
DISTRIBUTION OF PERSONNEL*
 FLEET MARINE FORCE, PACIFIC

26 FEBRUARY 1970

UNIT	NOTE	ASSIGNED STRENGTH		STR RPT DATE	DANANG		CHU LAI		PHU BAI		No I CTZ		OKINAWA		JAPAN		HAWAII		EASTPAC		OTHER	
		USMC	USN		USMC	USN	USMC	USN	USMC	USN	USMC	USN	USMC	USN	USMC	USN	USMC	USN	USMC	USN	USMC	USN
HEADQUARTERS																						
HQ, FMF, PAC																						
H&S BN, FMF, PAC		1668		8FEB70													1668					
CAMP S. D. BUTLER		576		26FEB70								576										
CASUAL		107		26FEB70								107										
HOSPITALIZED	5	563		26FEB70								1										562
HQ, V MEB																						
1ST CIVAFFGRP		74	4															74	4			
H&S CO, 5TH MEB		1393	27															1393	27			
HQ, FORTRPS, FMF PAC																						
HQCO, FORTRPS		239	26																	239	26	
HQ, 1ST MAR BRIG																						
HQCO, 1ST MAR BRIG		252	26													252	26					
I MEF																						
HQ 3RD MARDIV																						
HQBN 3RD MARDIV		1424	56									1424	56									
HQ III MAF																						
H&S CO III MAF		1122	29		1122	29		518														
1ST CAG		518																				
2D CAG		648			648																	
3D CAG		533							533													
4TH CAG		365								365												
HQ 1ST MARDIV																						
HQBN 1ST MARDIV	3	2415	39		2366	39																49
INFANTRY																						
1ST MARINES																						
HQ CO																						
1ST BATTALION		289	9		289	9																
2D BATTALION		1064	58		1064	58																
3D BATTALION		1081	56		1081	56																
3D MARINES																						
HQ CO																						
1ST BATTALION		317	7																	317	7	
2D BATTALION		1438	78													1438	78			1009	59	
3D BATTALION		1009	59																961	55		
4TH MARINES																						
HQ CO																						
1ST BATTALION		183	7									183	7									
2D BATTALION		979	52									979	52									
3D BATTALION		851	49									851	49									
5TH MARINES																						
HQ CO																						
1ST BATTALION		430	13		430	13																
2D BATTALION		1049	56		1049	56																
3D BATTALION		1046	58		1046	58																
7TH MARINES																						
HQ CO																						
1ST BATTALION		329	12		329	12																
2D BATTALION		1013	56		1013	56																
3D BATTALION		1058	53		1058	53																
9TH MARINES																						
HQ CO																						
1ST BATTALION		264	10									264	10									
2D BATTALION	1	1459	81									1459	81									
3D BATTALION		1101	51																			1101 51
26TH MARINES																						
HQ CO																						
1ST BATTALION		304	6		304	6																
2D BATTALION		1062	57		1062	57																
3D BATTALION		1080	58		1080	58																
ARTILLERY																						
11TH MARINES																						
HQ BTRY																						
1ST BATTALION		444	9		444	9																
2D BATTALION		598	17		598	17																
3D BATTALION		584	16		584	16																
4TH BATTALION		642	16		642	16																
12TH MARINES																						
HQ BTRY																						
1ST BATTALION		225	15									225	15									
2D BATTALION		1095	21																	1095	21	
3D BATTALION		641	17									641	17									
4TH BATTALION		563	15									563	15									
		362	15									362	15									

Unclassified

UNCLASSIFIED

* UNLESS OTHERWISE NOTED, STRENGTHS AND LOCATION ARE THOSE REPORTED BY UNIT PERSONNEL STATUS REPORTS AND DO NOT REFLECT DAY-TO-DAY ADJUSTMENTS BETWEEN REPORTING PERIODS.
 **UNLESS OTHERWISE NOTED STRENGTH REPORT DATE IS 12FEB70.

UNCLASSIFIED

DISTRIBUTION OF PERSONNEL

FLEET MARINE FORCE, PACIFIC

26 FEBRUARY 1970

Table with columns: UNIT, NOTE, ASSIGNED STRENGTH (USMC, USN), STR RPT DATE, DANANG, CHU LAI, PHU BAI, No I CTZ, OKINAWA, JAPAN, HAWAII, EASTPAC, OTHER.

AVIATION UNITS

Table listing aviation units and personnel counts for various squadrons and groups, including HQ SQDN FMFPAC, 1ST MAW, MAG-11 through MAG-16, MCAF FUTEMA, and MAG-36.

Unclassified

UNCLASSIFIED DISTRIBUTION OF PERSONNEL

FLEET MARINE FORCE, PACIFIC

26 FEBRUARY 1970

UNIT	NOTE	ASSIGNED STRENGTH		STRENGTH RPT DATE	DANANG		CHU LAI		PHU BAI		No I CTZ		OKINAWA		JAPAN		HAWAII		EASTPAC		OTHER	
		USMC	USN		USMC	USN	USMC	USN	USMC	USN	USMC	USN	USMC	USN	USMC	USN	USMC	USN	USMC	USN	USMC	USN
1ST BRIG																						
MAG-24																						
H&MS-24		455															455					
MABS-24		349	27														349	27				
MACS-2		200															200					
MATCU-70		40															40					
VMFA-212		278															278					
VMFA-235		266															266					
3D MAW																						
MWHG-3																						
H&HS-3		671	99																671	99		
MWFS-3		174																	174			
MWCS-3		265																	265			
MCCRTG-10																						
H&MS-10		279	2																	279	2	
VMAT-102		208																		208		
VMT-103		190																		190		
MHTG-30																						
H&MS-30		358	1																	358	1	
HMHT-301		164	1																	164	1	
HMMT-302		191	1																	191	1	
MAG-33																						
H&MS-33		926	1																	926	1	
MABS-33		533	3																	533	3	
MATCU-65		61																		61		
VMCJ-3		371	1																	371	1	
VMA-223	7	166	1																	166	1	
VMA-214		218																		218		
VMFA-531		380	1																	380	1	
VMFA-542		269	1																	269	1	
VMFA-323 (CADRE)		12																		12		
VMFAT-101		511																		511		
MMSG-37																						
H&MS-37		663	3																	663	3	
WERS-37		308	1																	308	1	
VMGR-352		371	1																	371	1	
MAG-38																						
H&HS-38		312	2																	312	2	
MACS-1		301																		301		
MACS-3		269	4																	269	4	
MACS-7		284	1																	284	1	
1ST LAAM BN		144																		144		
2ND LAAM BN		764	18																	764	18	
MAG-56																						
H&MS-56		483																		483		
MABS-56		467	2																	467	2	
MATCU-74		81																		81		
HMM-163		255	1																	255	1	
HML-267		383	5																	383	5	
HMM-265		215	1																	215	1	
HMH-363		274																		274		
MATCU-75		48																		48		
HMH-361	7	185	1																	185	1	
USMC		30,998			8,068	3,098	0	0	2,434	3,809	1,649	11,754	186									
USN		458			135	66	0	0	48	27	27	152	3									
AVIATION TOTAL		31,456			8,203	3,164	0	0	2,482	3,836	1,676	11,906	189									

RECAPITULATION OF FMFPAC PERSONNEL DISTRIBUTION

		ASSIGNED STRENGTH	DANANG	CHU LAI	PHU BAI	No I CTZ	OKINAWA	JAPAN	HAWAII	EASTPAC	OTHER
GROUND TOTAL	USMC	76,940	38,481	1,569	685	789	16,500	0	3,553	13,511	1,852
	USN	3,441	1,824	21	7	13	889	0	109	524	54
AVIATION TOTAL	USMC	30,998	8,068	3,098	0	0	2,434	3,809	1,649	11,754	186
	USN	458	135	66	0	0	48	27	27	152	3
GRAND TOTAL	USMC	107,938	46,549	4,667	685	789	18,934	3,809	5,202	25,265	2,038
	USN	3,899	1,959	87	7	13	937	27	136	676	57

- NOTES:**
- FIGURES IN "OTHER" ASSIGNED TO SLP'S.
 - FIGURES IN "OTHER" ASSIGNED TO VARIOUS LOCATIONS IN RVN.
 - PERSONNEL IN "OTHER" ARE ASSIGNED TO IT, IIT, SSC, CIT, RED EYE AND NUCLEAR ORINANCE PLATOONS.
 - STRENGTH INCLUDED IN 1ST AND 3D TANK BATTALIONS.
 - THE 559 PERSONNEL LISTED IN "OTHER" ARE HOSPITALIZED AT LOCATIONS OTHER THAN OKINAWA, BUT ARE CARRIED ON THE ROLLS OF CASUAL COMPANY, MCB, CAMP BUTLER.
 - AT SUBIC
 - ENROUTE EASTPAC.
 - PERSONNEL ARE NON-FMF CARRIED FOR OSD PROGRAM STRENGTH TOTALS ONLY.
 - UNLESS OTHERWISE NOTED, STRENGTHS AND LOCATION ARE THOSE REPORTED BY UNIT PERSONNEL STATUS REPORTS AND DO NOT REFLECT DAY-TO-DAY ADJUSTMENTS BETWEEN PERIODS.
 - UNLESS OTHERWISE NOTED STRENGTH REPORT DATE IS 12FEB70.

Unclassified

UNCLASSIFIED

UNCLASSIFIED

SELECTED UNIT COMMANDERS AND STAFF OFFICERS

26 FEBRUARY 1970

HEADQUARTERS III MARINE AMPHIBIOUS FORCE

COMMANDING GENERAL	LTGEN H. NICKERSON, JR.
DEPUTY COMMANDER	MGEN G. S. BOWMAN, JR.
CHIEF OF STAFF	BGEN L. J. DULACKI
DEPUTY CHIEF OF STAFF:	COL S. A. DRESSIN
ACOS, G-1	COL R. L. PARNELL, JR.
ACOS, G-2	COL E. W. DZIALO
ACOS, G-3	BGEN T. H. MILLER, JR.
ACOS, G-4	COL W. F. SIMLIK
ACOS, G-5	COL C. J. PEABODY
ACOS, G-6	LTCOL R. S. BARRY
ACOS, COMPT	LTCOL J. M. VOSMIK
DEP C/S SPECIAL PROJECTS	COL A. T. WOOD

CG XXIV CTZ	LTGEN M. ZAIS USA
DEP C/S XXIV CTZ	COL M. M. COOK USMC

ACOS, CAP	COL T. E. METZGER
COMMANDING OFFICER, 1ST CAG	LTCOL D. F. SEILER
COMMANDING OFFICER, 2ND CAG	LTCOL D. R. CHRISTENSEN
COMMANDING OFFICER, 3RD CAG	LTCOL C. M. DANIELS
COMMANDING OFFICER, 4TH CAG	LTCOL J. J. KEENAN
1ST RADIO BATTALION	LTCOL D. M. HOPKINS

1ST MARINE DIVISION

COMMANDING GENERAL	MGEN E. B. WHEELER
ADC	BGEN W. F. DOEHLER
CHIEF OF STAFF	COL C. E. WALKER
ACOS, G-1	COL R. E. BARDE
ACOS, G-2	
ACOS, G-3	COL F. H. WALDROP
ACOS, G-4	COL N. A. CANZONA
ACOS, G-5	COL L. S. HULLIER
ACOS, COMPT	LTCOL N. M. LASLAVIC, JR.
CEO	COL C. G. DAHL

1ST MARINES

COMMANDING OFFICER	COL E. A. WILCOX
1ST BATTALION	LTCOL G. S. DELCUZE
2ND BATTALION	LTCOL W. V. H. WHITE
3RD BATTALION	LTCOL F. M. BOYD

5TH MARINES

COMMANDING OFFICER	COL R. F. ESTEY
1ST BATTALION	LTCOL J. K. GRIFFIS, JR.
2ND BATTALION	LTCOL F. LEDER
3RD BATTALION	LTCOL J. S. GESTSON

7TH MARINES

COMMANDING OFFICER	COL G. S. CODISPOTI
1ST MARINES	LTCOL C. G. COOPER
2ND MARINES	LTCOL A. E. FOLSOM
3RD MARINES	LTCOL R. G. KUMMEROW

26TH MARINES

COMMANDING OFFICER	COL J. E. HARRELL
1ST BATTALION	LTCOL J. C. GOODIN
2ND BATTALION	LTCOL P. L. HUMPHREY
3RD BATTALION	LTCOL J. J. UNTERKOFER

11TH MARINES

COMMANDING OFFICER	COL D. D. EZELL
1ST BATTALION	LTCOL J. D. SHOUP
2ND BATTALION	LTCOL V. WEAVER
3RD BATTALION	LTCOL K. N. MUELLER
4TH BATTALION	LTCOL J. F. BURKE, JR.

1ST BN, 13TH MAR	LTCOL D. H. STRAIN
------------------	--------------------

HQS BATTALION	COL W. C. PATTON
---------------	------------------

1ST ENGR BATTALION	LTCOL N. F. GLOWICKI
1ST RECON BATTALION	LTCOL W. C. DRUMWRIGHT
1ST MT BATTALION	LTCOL M. S. SHIMANOFF
1ST SP BATTALION	COL R. F. ARMSTRONG
1ST MED BATTALION	CAPT(MC) J. W. LEA
1ST TK BATTALION	MAJOR J. I. LOUDER
3RD AMTRAC BATTALION	LTCOL D. G. MEHARGUE
7TH ENGR BATTALION	LTCOL W. G. BATES
9TH ENGR BATTALION	LTCOL E. K. MAXWELL
11TH MT BATTALION	LTCOL W. R. KEPHART

FORCE LOGISTICS COMMAND

COMMANDING GENERAL	BGEN M. J. PADALINO
CHIEF OF STAFF	COL J. L. TOBIN
ACOS, G-1	LTCOL J. E. REDELFS
ACOS, G-2	LTCOL R. L. SOLZE
ACOS, G-3	LTCOL W. W. STORM, III
ACOS, G-4	LTCOL M. H. IVINS
ACOS, G-5	MAJOR R. E. JOHNSON
ACOS, COMPT	LTCOL F. R. WARREN
CEO	MAJOR R. D. HAGAN

1ST FORCE SERVICE REGT

H&S BATTALION	LTCOL L. R. WEBB
SUPPLY BATTALION	COL R. W. CALVERT
MAINT BATTALION	LTCOL E. C. MORRIS

FLSG-B/1ST SERV BN	COL D. E. MORIN
5TH COMM BATTALION (REIN)	LTCOL D. E. SHATZER

1ST MP BATTALION	LTCOL S. D. THOMAIDIS
3RD MP BATTALION	LTCOL C. FIMIAN

UNCLASSIFIED

~~SECRET~~

UNCLASSIFIED

MARINE CORPS COMMAND CENTER

MARINE CORPS PERSONNEL IN RVN

26 FEBRUARY 1970

	OFF	ENL	TOTAL
* III MAF.	3,421	48,134	51,555
DANANG	(2,990)	(41,737)	(44,727)
CHU LAI	(376)	(4,854)	(5,230)
PHU BAI	(21)	(860)	(881)
DONG HA	(34)	(683)	(717)
SU #1, 1ST ANGLICO (AT VARIOUS LOCATIONS SVN)	((21))	((194))	((215))
OTHER USMC PERSONNEL	159	150	309
MACV STAFF/MACV FIELD	(136)	(137)	(273)
NAVAIDVGRU/NAVY UNITS	(23)	(13)	(36)
USMC IN RVN CHARGED AGAINST PROGRAM VIII	3,580	48,284	51,864
U. S. NAVY, III MAF.	255	1,762	2,017

* AS REPORTED BY III MAF DAILY ADMIN SITREP # 49 AS OF 2400, 17FEB70 AND THE MACV WEEKLY STRENGTH REPORT, AS OF 2400, 19FEB70 AS ADJUSTED BY MACV DAILY RPT OF ARR/DEP AS OF 2400, 24FEB70

Unclassified

UNCLASSIFIED

~~SECRET~~

WESTPAC UNIT LOCATIONS

26 FEBRUARY 1970

QUANG TRI

(QUANG TRI)

USMC 717
USN 36 *
USA 8,807

- 1ST BDE, 5TH INF DIV (MECH)
- 1/77 ARMOR (OPN GREENE RIVER)
- 1/61 INF (MECH) (OPN GREENE RIVER)
- 1/11 INF (OPN GREENE RIVER)
- 3/5 ARMD CAV SQDN (OPN GREENE RIVER)

THUA THIEN

HQ, XXIV CORPS (PHU BAI)

HQ, 101st ABN DIV (AM)

- 1ST BDE, 101ST ABN DIV (AM)
 - 1/327 INF (AM) (OPN RANDOLPH GLEN)
 - 2/327 INF (AM) (OPN RANDOLPH GLEN)
 - 2/502 INF (AM) (OPN RANDOLPH GLEN)
- 2D BDE, 101ST ABN DIV (AM)
 - 1/501 INF (AM) (OPN RANDOLPH GLEN)
 - 2/501 INF (AM) (OPN RANDOLPH GLEN)
 - 1/502 INF (AM) (OPN RANDOLPH GLEN)
- 3D BDE, 101ST ABN DIV (AM)
 - 1/506 INF (AM) (OPN RANDOLPH GLEN)
 - 2/506 INF (AM) (OPN RANDOLPH GLEN)
 - 3/187 INF (AM) (OPN RANDOLPH GLEN)

USMC 881
USN 46 *
USA 23,265

QUANG NAM

HQS 1ST MAR DIV (DANANG)

1ST MARINES

- 1/1
- 2/1
- 3/1

5TH MARINES

- 1/5
- 2/5
- 3/5

7TH MARINES

- 1/7
- 2/7
- 3/7

26TH MARINES

- 1/26
- 2/26
- 3/26

HQS, III MAF

USMC 44,727 *
USN 1,819 *
USA 1,104
ROKMC 6,115

HQ 1st MAW
MAG-11

- VMA(AW)-242 (A-6A)
- VMA(AW)-225 (A-6A)
- VMCJ-1 (RF-4/EA-6/EF-10)
- VMO-2 (OV-10A)

MAG-16

- HML-367 (AH-1G)
- HML-167 (UH-1E)
- HMH-463 (CH-53A)
- HMM-364 (CH-46D)
- HMM-263 (CH-46D)
- HMM-262 (CH-46D)
- HMM-161 (CH-46C)

2d ROKMC BDE

- 1/2 (OPN VICTORY DRAGON XIX)
- 2/2 (OPN VICTORY DRAGON XIX)
- 3/2 (OPN VICTORY DRAGON XIX)
- 5/2 (OPN VICTORY DRAGON XIX)

FLC 1ST FSR/FLSG-B/1ST SERV BN

QUANG TIN/QUANG NGAI

HQ 23d INF DIV (AMERICAL) (CHU LAI)

196TH LT INF BDE

- 2/1 INF (OPN FREDERICK HILL)
- 4/31 INF (OPN FREDERICK HILL)
- 3/21 INF (OPN FREDERICK HILL)
- 1/46 INF

198TH LT INF BDE

- 1/6 INF (OPN GENEVA PARK)
- 1/52 INF (OPN GENEVA PARK)
- 5/46 INF (OPN NANTUCKET BEACH)

11TH INF BDE

- 1/20 INF (OPN IRON MOUNTAIN)
- 4/21 INF (OPN IRON MOUNTAIN)
- 3/1 INF (OPN IRON MOUNTAIN)
- 4/3 INF (OPN IRON MOUNTAIN)
- 1/1 ARMD CAV SQDN (OPN IRON MOUNTAIN)

1st MAW

MAG-12

MAG-13

- VMFA-115 (F-4B)
- VMFA-314 (F-4B)
- VMFA-122 (F-4B)
- VMA-311 (A-4E)

USMC 5,230
USN 116 *
USA 24,430

OKINAWA

HQ, I MEF

3D MARDIV (-)(REIN)(TF-79)

11th MEB (TF-79.1)

4TH MARINES

- 1/4
- 2/4
- 3/4

9TH MARINES

- 3/9

MAG-36

- VMGR-152 (KC-130F)
- VMO-6 (OV-10A/UH-1E)
- HMH-462 (CH-53A)

3D FSR
MCB CAMP BUTLER/NON FMF
Non-Deployable Casuals
SVN-Originated Patients

USMC 19,200
USN 934
ACTUALS CHARGED AGAINST PROGRAM VIII AS OF 26FEB70. 18,387 *
(13,888) *
(3,459) *
(932) *
(1) *

USMC RVN RECAP

USMC USN *

OSD PROGRAM IX CEILING
EFFECTIVE 15APR70.....42,610 1,811
OSD PROGRAM VIII CIELING..55,510 2,233
PROGRAM VIII AS OF 24FEB70.51,864 * 2,017
III MAF.....51,555 * 2,017
SU#1 1ST ANGLICO..... (215) (12)
OTHER..... 309
MACV STAFF/MACV FIELD. (273)
NAVAVGRU/NAVY UNITS.. (36)

I CORPS RECAP

US MARINE CORPS... (12 BNs) 51,555 *
US ARMY... (25 BNs) 73,849
US NAVY... 16,822 *
US AIR FORCE... 8,194
ROKMC... (4 BNs) 6,115
RVNAF... (36 BNs) 153,895
ARVN/ABN... (36 BNs) (74,634)
VNM... (2,100)
VNN... (3,408)
VNAP... (37,403)
VNR... (36,350)
VNP... (36,350)

I CORPS TOTAL... 77 BN 310,430 *

SLF 7TH FLEET

USMC USN

BRVO: BLT 2/9 1,847 60
HMM-165
AT SUBIC

ALFA: BLT 1/9 1,868 85
HMM-164
AT OKINAWA

MOVEMENTS

Det 12th Mar and "D" Co, 3d Recon Bn, At Fuji for training.

JAPAN

USMC USN

OSD PROGRAM IX CEILING
EFFECTIVE 15APR70. 4,700 73
OSD PROGRAM VIII CIELING 3,600 45
ACTUALS CHARGED AGAINST PROGRAM VIII AS OF 26FEB70. 3,764 * 34

1ST MAW (REAR)

MAG-15 (2,564) (34)
VMFA-232 (F-4J)
VMFA-334 (F-4J)
VMA(AW)-533 (A-6A)
VMA-211 (A-4E)
(Less command)
Non FMF (1,200) *

*Does NOT include 276 hospitalized SVN-Originated Patients

Unclassified

* Includes only U. S. Navy Personnel organic to FMF Units.
Includes SU#1 and 1st ANGLICO at various locations throughout SVN.
Latest Change

UNCLASSIFIED



MARINE CORPS

FEB 26 1970

REFERENCE BRANCH

Unclassified



UNCLASSIFIED

SUMMARY OF MAJOR US AND FWMAF OPERATIONS

OPERATION (DATE COMMENCED)	UNITS INVOLVED	LOCATION	CASUALTIES AS OF: 262400H FEB70		
			FRIENDLY		ENEMY
			KIA	WIA	KIA
GREENE RIVER (19JAN70)	1ST BDE, 5TH INF DIV (MECH); 4 USA BNS	EASTERN QUANG TRI PROVINCE	5	133	77
RANDOLPH GLEN (7DEC69)	101ST ABN DIV (AM); 9 USA BNS	QUANG TRI & THUA THIEN PROVINCES	56	311	462
VICTORY DRAGON XIX (1JAN70)	2D ROKMC BDE; 4 ROKMC BNS	HOI AN AREA	2	13	23
FREDERICK HILL (18MAR69)	196TH INF BDE; 3 USA BNS	QUANG TIN PROVINCE	390	2,429	4,599
GENEVA PARK (18JUL69)	198TH INF BDE; 2 USA BNS	QUANG TIN & QUANG NGAI PROVINCES	132	874	1,246
NANTUCKET BEACH (20JUL69)	198TH INF BDE; 1 USA BN	CENTERED 15 KM NE OF QUANG NGAI CITY	24	224	251
IRON MOUNTAIN (18MAR69)	11TH INF BDE; 5 USA BNS	QUANG NGAI PROVINCE	291	1,694	2,568

* - ADJUSTED
- FINAL CUMULATIVE CASUALTIES

UNCLASSIFIED

Unclassified

UNCLASSIFIED

MARINE CORPS COMMAND CENTER

USMC/ENEMY CASUALTIES IN RVN

26 FEBRUARY 1970

USMC BATTLE CASUALTIES

KIA/DOW	WIA(EVAC)	WIA(RTD)	MIA/PW
12,495	48,963	35,867	81/21

USMC CASUALTY FIGURES ARE PROVIDED DAILY BY HOMC CASUALTY SECTION (CODE DNA) AND REFLECT ALL CASUALTIES REPORTED AS OF 24FEB70.

USMC NON-BATTLE CASUALTIES

DEAD	INJURED	MISSING
1,515	1,823	13

FIGURES INDICATED AS INJURED ARE ONLY THOSE IN SERIOUS CRITICAL INJURY OR DISEASE CATEGORY AND DO NOT INCLUDE THOSE OF A MINOR NATURE

USMC INFLICTED ENEMY CASUALTIES

KIA	PW	WPNS
80,876	4,210	20,828

ENEMY CASUALTIES ARE COMPILED DAILY FROM THE III MAF HISSUM AND ARE RECONCILED MONTHLY WITH THE FMFPAC SUMMARY OF USMC OPERATIONS IN RVN

TYPICAL DISPOSITION OF 100 USMC WIA *

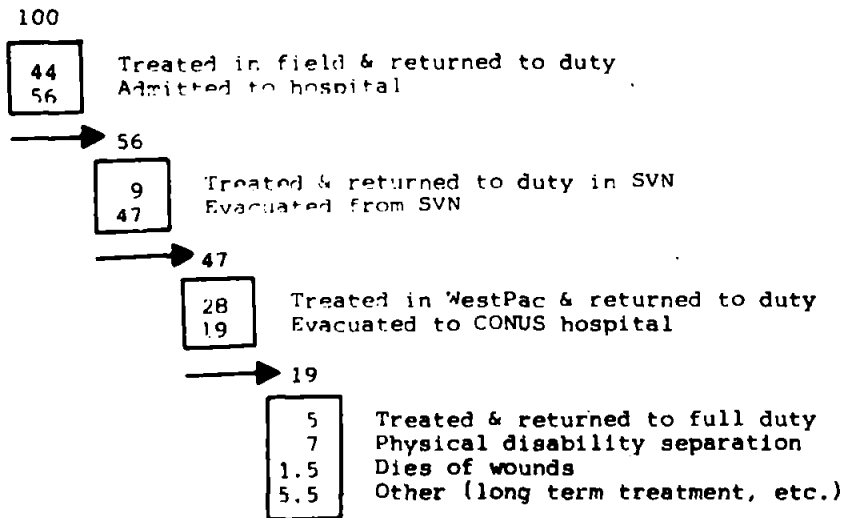

*54,081 CASUALTIES, JAN67-DEC68.

UNCLASSIFIED
Unclassified

UNCLASSIFIED

26 FEBRUARY 1970

MARINE CORPS COMMAND CENTER

MILITARY FORCES IN RVN *

RVN ARMED FORCES (RVNAF)

ARMY (ARVN)	416,278
NAVY (VNN)	30,143
AIR FORCE (VNAF)	36,469
MARINE CORPS (VNMC)	11,528
REGIONAL FORCES (RF)	260,455
POPULAR FORCES (PF)	214,383
TOTAL RVNAF	969,256

UNITED STATES FORCES

ARMY	334,363
NAVY	29,017
AIR FORCE	56,106
MARINE CORPS	51,864
COAST GUARD	354
TOTAL U.S.	471,704

FREE WORLD MILITARY ASSISTANCE FORCES (FWMAF)

REPUBLIC OF KOREA	48,806
AUSTRALIA	7,593
PHILIPPINES	133
THAILAND	11,555
NEW ZEALAND	552
REPUBLIC OF CHINA	28
SPAIN	11
TOTAL FWMAF	68,691

TOTAL FORCES IN RVN 1,509,651

SOURCE: RVNAF MACV MONTHLY STRENGTH REPORT. ALL OTHER:
 MACV WEEKLY STRENGTH REPORT AS OF 2400, 19FEB70.
 USMC STRENGTH: MACV WEEKLY STRENGTH REPORT AS
 ADJUSTED BY MACV RPT OF ARR/DEP AS OF 2400, 24FEB70.

UNCLASSIFIED
Unclassified

~~CONFIDENTIAL~~
UNCLASSIFIED

26 FEBRUARY 1970

COMMANDERS AND PRINCIPAL STAFF OFFICERS, HQ USMACV

<p>COMUSMACV Dep COMUSMACV Dep COMUSMACV for Air Dep COMUSMACV for Civ Opns and Revolutionary Development Support (CORDS) 1/ CofS, MACV Dep CofS, MACV ACofS, J1 ACofS, J2 ACofS, J3 Dep ACofS, J3 Dep ACofS, J3 ACofS, J4 ACofS, J5 ACofS, J6 ACofS, Military Assistance MACV Dir of Training/Spec Asst to COMUSMACV ACofS for CORDS Dep ACofS for CORDS Comptroller Dir of Construction Chief of SOG Chief of Information Surgeon, MACV</p>	<p>GEN Creighton W. Abrams, USA GEN William B. Rosson, USA GEN George S. Brown, USAF Amb William E. Colby MG Elias C. Townsend, USA BG James M. Vandehey, USAF BG Albert H. Smith, Jr., USA (P) BG William E. Potts, USA MG Edward Bautz, Jr., USA BG William R. Kraft, Jr., USA BG Samuel Jaskilka, USMC MG Raymond C. Conroy, USA MG Richard F. Shaefer, USAF BG Geoffrey Cheadle, USAF BG Frank L. Gunn, USA BG Wallace L. Clement, USA Mr. George D. Jacobson BG David S. Henderson COL Richard G. Fazakerley, USA BG Elmer P. Yates, USA COL Stephen E. Cavanaugh, USA COL Joseph F. H. Cutrona, USA BG Richard R. Taylor, USA</p>
---	---

SELECTED COMMANDERS AND STAFF OFFICERS IN USARV

<p>Dep CG, USARV CofS, USARV Dep CofS, Plans & Opns Dep CofS, Pers & Admin Asst CofS, C-E, USARV Aviation Officer, USARV Engineer Officer, USARV Provost Marshal, USARV Surgeon, USARV CG, Engr Const Agency, USARV CG, Capital Military Assistance Command ■ DCG, Capital Military Assistance Command</p>	<p>LTG Frank T. Mildren MG George L. Mabry, Jr. BG Frank Meszar BG Verne L. Bowers (P) MG Thomas M. Rienzi BG George W. Putnam, Jr. BG John A. B. Dillard COL Wallace K. Wittwer BG David E. Thomas BG Robert M. Tarbox Vacant COL Byron D. Greene, Jr. (Actg)</p>
---	---

HQ III MAF

<p>Commanding General Deputy Commanding General CofS DCSOPS ACofS, G3</p>	<p>LTG Herman Nickerson, Jr., USMC MG George S. Bowman, Jr., USMC BG George E. Dooley, USMC COL John R. Thurman III, (P) USA BG Leo J. Dulacki, USMC</p>
---	--

ARMY MAJOR UNITS COMMANDERS IN THAILAND

<p>Commander, USMACTHAI, and Chief, JSMAG, Thailand Deputy Commander, USMACTHAI US Army Spt Thailand Depot Command/Director for Supply 2/ 40th MP Bn 538th Engr Const Bn 809th Engr Const Bn 7th Maint Bn 29th Sig Gp (STRATCOM) 379th Sig Bn (Spt) 519th Trans Bn (Trk) 133d Med Gp 46th SF Co 442d Sig Bn (Long Line) 93d PSYOP Co 302d Sig Bn 325th Sig Bn</p>	<p>MG Louis T. Seith, USAF MG Jack J. Wagstaff, USA BG David E. Ott COL Raymond A. Troxell LTC Thomas M. Jones LTC Bernard C. Hughes LTC Joseph S. Nood, Jr. LTC Roland E. Berg COL Donald L. Jenkins LTC Harry J. Walther LTC Robert L. Vidrick COL Arthur A. Terrill LTC Stephen R. Johnson LTC Ed E. Jones MAJ Dale C. Skillicorn LTC Norman F. Hubbard MAJ William E. Moore</p>
---	---

1/ CORDS has been changed from Civil Operations and Revolutionary Development Support to Civil Operations and Rural Development Support to more accurately describe functions and align CORDS with the newly named CVN Ministry of Rural Development. The organization and functions of CORDS remain the same.
 2/ Previously 9th Log Comd.

DATE FOR REMOVAL OF PROTECTIVE MARKINGS CANNOT BE PREDETERMINED.

~~CONFIDENTIAL~~

26-2

UNCLASSIFIED

Unclassified

(pp. 9 dtd 26 Feb 70

~~UNCLASSIFIED~~

**GENERAL OFFICERS AND COMMANDERS OF MAJOR UNITS AND MANEUVER BATTALIONS
AND
DIVISION CHIEFS OF STAFF**

HQ USARV		HQ I FIELD FORCE RVN	
Commanding General	GEN Creighton W. Abrams	Commanding General	LTC Charles A. Corcoran
Dep Commanding General	LTC Frank T. Mildren	Dep Commanding General	MG Joseph R. Russ
Chief of Staff	MG George L. Mabry, Jr.	Chief of Staff	MG Richard H. Johnson
Dep CofS, Plans & Opns	MG Frank Messer	Artillery Officer	COL Charles W. Hall (P)
Dep CofS, Pers & Admin	MG Verne L. Bowers (P)		
HQ XXIV CORPS		HQ II FIELD FORCE RVN	
Commanding General	LTC Melvin Zais, USA	Commanding General	LTC Julian J. Ewell
Dep Commanding General	MG Edwin B. Wheeler, USMC	Dep Commanding General	Vacant
Chief of Staff	MG William E. Shedd, III	Chief of Staff	MG Leo D. Kinnard
Artillery Officer	COL Robert C. Hixon (P)	Artillery Officer	MG Francis J. Roberts
1st Inf Div		101st Abn Div (Abnl)	
Asst Div Commander	MG Albert E. Milloy	Asst Div Commander	MG John M. Wright, Jr.
Asst Div Commander	MG Herbert E. Wolff	Asst Div Commander	MG James C. Smith
Chief of Staff	MG John Q. Henlon	Chief of Staff	MG John J. Hennessey (P)
Div Arty Commander	COL Albert G. Huns	Div Arty Commander	COL Hugh A. MacDonald
Spt Comd Commander	COL Patrick W. Powers	Spt Comd Commander	LTC Richard S. Fye (P)
	COL Frank D. Conant, Jr.		COL Robert H. Siegrist
1st Brigade		1st Brigade	
1st Bn, 2d Inf	COL Paul F. Brain	1st Bn (Abnl), 327th Inf	COL John D. White
1st Bn, 28th Inf	LTC Richard W. Anson	2d Bn (Abnl), 327th Inf	LTC Jeremiah J. Brophy
2d Bn 28th Inf	LTC Gus H. Watt	2d Bn (Abnl), 502d Inf	LTC Richard F. Fischer
2d Bn (Mech), 2d Inf	LTC Richard W. Hobbs	3d Bn (Abnl), 506th Inf	LTC Roy J. Young
	LTC Lee D. Brown		LTC Joseph N. Jaggars
2d Brigade		2d Brigade	
1st Bn (Mech), 16th Inf	COL Kyle W. Bowie	1st Bn (Abnl), 501st Inf	COL Raymond L. Kampe
2d Bn, 16th Inf	LTC David C. Martin	2d Bn (Abnl), 501st Inf	LTC William B. Middleton
2d Bn, 18th Inf	LTC William E. Panton	1st Bn (Abnl), 502d Inf	LTC Bobby F. Brashears
	LTC George E. Williams		LTC Robert E. Keener
3d Brigade		3d Brigade	
1st Bn, 18th Inf	Vacant	3d Bn (Abnl), 187th Inf	COL William J. Bradley
1st Bn, 26th Inf	LTC Thomas R. Finley	1st Bn (Abnl), 506th Inf	LTC Herbert Y. Schandler
	LTC Howard F. Stone	2d Bn (Abnl), 506th Inf	LTC David R. Pinney
			LTC Howard G. J. Crowell
1st Sqdn, 4th Cav		160th Avn Gp	
	LTC Frederic J. Brown	2d Sqdn (Abnl), 17th Cav	COL Christopher B. Sinclair
			LTC LaVerre W. Bindrup
1st Cav Div (Abnl)		23d Inf Div	
Asst Div Commander	MG Elvy B. Roberts	Asst Div Commander	MG Lloyd B. Ramsey
Asst Div Commander	MG Robert M. Shoemaker	Asst Div Commander	MG Edwin L. Powell, Jr.
Chief of Staff	MG George W. Casey (P)	Chief of Staff	MG John W. Donaldson
Div Arty Commander	COL Joseph P. Kingstern	Div Arty Commander	COL Thomas H. Tackberry
Spt Comd Commander	COL Morris J. Brady	Spt Comd Commander	COL Leslie B. Hardy
	COL Tom M. Nicholson		COL Kendrick B. Barlow
1st Brigade		11th Inf Brigade	
2d Bn (Abnl), 7th Cav	COL Joseph E. Collins	3d Bn, 1st Inf	COL Hugh F. T. Hoffman
2d Bn (Abnl), 5th Cav	LTC Robert Hannas	4th Bn, 3d Inf	LTC Leslie J. Stottle
2d Bn (Abnl), 8th Cav	LTC John R. Witherell	1st Bn, 20th Inf	LTC Stanley V. Nielsa
	LTC Michael J. Conrad	4th Bn, 21st Inf	LTC Arthur F. Fischer
			LTC George R. H. Johnson
2d Brigade		196th Inf Brigade	
2d Bn (Abnl), 12th Cav	COL Edward C. Meyer	2d Bn, 1st Inf	COL James M. Lee
5th Bn (Abnl), 7th Cav	LTC Harold E. Iverson	3d Bn, 21st Inf	LTC Francis A. Nerone
1st Bn (Abnl), 12th Cav	LTC Sanders A. Cortner	4th Bn, 31st Inf	LTC Robert C. Bacon
	LTC Roderic E. Ordway		LTC Kenneth L. Skaer
3d Brigade		198th Inf Brigade	
1st Bn (Abnl), 5th Cav	COL Robert C. Kingstern	1st Bn, 6th Inf	COL Joseph G. Clemons
1st Bn (Abnl), 7th Cav	LTC James L. Anderson	1st Bn, 46th Inf	LTC H. Norman Schwarzkopf
1st Bn (Abnl), 8th Cav	LTC Robert L. Drendik	5th Bn, 46th Inf	LTC Peter J. Foss
	LTC William J. McClesley	1st Bn, 52d Inf	LTC Melvin C. Snyder, Jr.
			LTC Arthur E. Brown, Jr.
11th Avn Gp		25th Inf Div	
	COL Kenneth D. Mertei	Asst Div Commander	MG Harris W. Hollis
1st Sqdn (Abnl), 9th Cav	LTC James W. Booth	Asst Div Commander	MG Michael J. L. Greene
		Chief of Staff	MG Thomas J. Camp, Jr.
		Div Arty Commander	COL James M. Connell
		Spt Comd Commander	COL Harry A. Buzzett
			COL Robert E. Hammerquist
4th Inf Div		1st Brigade	
Asst Div Commander	MG Glenn D. Walker	4th Bn, 9th Inf	COL Paul J. Mueller, Jr.
Asst Div Commander	MG Jack MacFarlane	3d Bn, 22d Inf	LTC Forest S. Ritzgers, Jr.
Chief of Staff	MG John G. Wheelock, III	4th Bn (Mech), 23d Inf	LTC Warren A. Jones
Div Arty Commander	COL Joseph E. McCarthy		LTC James E. Coggins
Spt Comd Commander	COL Edward F. Gudge, Jr.		
	COL John F. Culin		
1st Brigade		2d Brigade	
1st Bn, 8th Inf	COL Harold D. Yew	1st Bn (Mech), 5th Inf	COL Ennis C. Whitehead
3d Bn, 8th Inf	LTC Richard E. Mack	2d Bn, 12th Inf	LTC Ted G. Westerman
1st Bn, 14th Inf	LTC Franklin D. Hicks	2d Bn, 27th Inf	LTC Shepperd H. Phillips
1st Bn, 22d Inf	LTC Andrew M. Simko		LTC George A. Custer
	LTC Michael P. Juvenal		
2d Brigade		3d Brigade	
1st Bn, 12th Inf	COL William E. Conger	2d Bn, 14th Inf	COL Olin E. Smith
1st Bn, 35th Inf	LTC John R. Cottingham	2d Bn (Mech), 22d Inf	LTC Donald O. Crutchley
2d Bn, 35th Inf	LTC Cliff R. Hish	1st Bn, 27th Inf	LTC John R. Parker
	LTC Dwight L. Adams		LTC Thomas K. Whitesel
3d Brigade		3d Sqdn, 4th Cav	
2d Bn (Mech), 8th Inf	COL Gilbert Proctor, Jr.	2d Bn, 34th Cav	LTC Corwin A. Hitchell
3d Bn, 12th Inf	LTC Charles E. Thomann		LTC William M. Greenberg
	LTC John W. Foss		
1st Sqdn, 10th Cav	LTC William J. Moran		
1st Bn, 69th Arm	LTC James L. Marini		

1/ UPGUN to the 173d Abn Bde.

DATE FOR REMOVAL OF PROTECTIVE
MARKINGS CANNOT BE DETERMINED.

~~UNCLASSIFIED~~

Unclassified

**GENERAL OFFICERS AND COMMANDERS OF MAJOR UNITS AND MANEUVER BATTALIONS
AND
DIVISION CHIEFS OF STAFF**

<u>1st Fld Arty Div (Mech)</u> 1st Bn, 11th Inf 1st Bn (Mech), 61st Inf 1st Bn, 77th Arty	MG William A. Burke LTC James D. Herndon LTC John W. Swaren, Jr. LTC Niven J. Baird	<u>I FFV Arty</u> 33d Arty Gp I FFV Prov Arty Gp	COL Charles M. Hall (P) COL Robert E. Wingenman COL Francis A. Bowers
<u>199th Inf Brigade</u> Deputy Commander 2d Bn, 3d Inf 3d Bn, 7th Inf 4th Bn, 12th Inf 5th Bn, 12th Inf	MG William R. Bond COL Robert W. Seltou LTC Benjamin I. Ivry, Jr. LTC Bibb A. Underwood LTC John R. Black LTC David A. Beckner	<u>II FFV Arty</u> 73d Arty Gp	MG Francis J. Roberts COL Joseph N. Hearin, Jr.
<u>173d Abn Brigade</u> Deputy Commander 1st Bn, 503d Abn Inf 2d Bn, 503d Abn Inf 3d Bn, 503d Abn Inf 4th Bn, 503d Abn Inf	MG Hubert S. Cunningham COL Elmer K. Ochs LTC Manley H. Cosper, Jr. LTC George N. Krause LTC Brutus A. Lowery, Jr. LTC Paul S. Lawrence	<u>XXIV Corps Arty</u> 108th Arty Gp	COL Robert C. Hixon (P) COL Milton L. Key
<u>3d Rde 9th Inf Div</u> 6th Bn, 31st Inf 2d Bn (Mech), 47th Inf 2d Bn, 60th Inf 5th Bn, 60th Inf	COL Andrew J. Catstis LTC Cornelius J. Gearin LTC John H. Claybrook LTC William N. Ciccolo LTC Davant T. Williams	<u>18th Engr Brigade</u> 35th Engr Gp 45th Engr Gp 937th Engr Gp	MG John N. Morris COL Harry A. Griffith COL William R. Wray COL Carroll E. Adams, Jr.
<u>11th Armd Cav Regt</u> 1st Recon Sqdn 2d Recon Sqdn 3d Recon Sqdn	COL Donn A. Starry LTC James B. Reed LTC Grahl L. Brookshire LTC George Hoffmaster	<u>20th Engr Brigade</u> 34th Engr Gp 79th Engr Gp 159th Engr Gp	COL Edwin T. O'Donnell (P) COL John E. Sterling COL Ernest J. Benz COL Joseph K. Bratton
<u>5th Spec Forces Gp</u>	COL Michael D. Healy	<u>1st Avn Brigade</u> Dep Commander 12th Avn Gp 16th Avn Gp 17th Avn Gp 164th Avn Gp 165th Avn Gp	MG George W. Putnam, Jr. COL Leo D. Turner (Actg) COL John C. Hughes COL Delbert L. Townsend COL William R. McHowell COL William J. Maddox COL William D. Proctor
<u>1st Sqdn, 1st Cav</u> <u>2d Sqdn, 1st Cav</u> <u>3d Sqdn, 5th Cav 1/</u>	LTC Richard G. Graves LTC Robert G. Bond LTC William N. Bradberry, Jr.	<u>1st Sig Bde (USASTRATCOM)</u> Dep Commanding General 2d Sig Gp 21st Sig Gp 160th Sig Gp Reg Comm Gp 12th Sig Gp	MG Thomas M. Rienzi MG Jack A. Albright COL Edward D. Heares COL James P. Mattern COL Bernard Pankowski COL John E. Hoover COL Dorward W. Ogden, Jr.
<u>7th Sqdn, 1st Air Cav</u> <u>3d Sqdn, 17th Air Cav</u> <u>7th Sqdn, 17th Air Cav</u>	LTC Ronald T. Walker LTC Robert A. Arnet LTC George S. Murry	<u>44th Med Brigade</u> 43d Med Gp 55th Med Gp 67th Med Gp 68th Med Gp	MG David E. Thomas COL Maurice S. Berbery COL Carl E. Vander Ploeg COL Daniel W. Pratt COL Merle D. Thomas
<u>1st Bn (Mech), 50th Inf</u>	LTC Robert J. Luck	<u>18th MP Brigade</u> 16th MP Gp 89th MP Gp 8th MP Gp	COL Wallace K. Wittwer LTC Harold S. Elliott (P) COL Angus B. MacLean COL James D. Tynan
		<u>1st Log Command</u> Deputy Commander USA Spt Comd, Cam Ranh Bay USA Spt Comd, Da Nang USA Spt Comd, Saigon USA Spt Comd, Qui Nhon	MG Walter J. Noolwine MG Hugh A. Richeson COL Henry R. Del Mar (P) COL Homer D. Smith, Jr. COL Harold B. Gibson, Jr. (P) MG Albert E. Hunter
		<u>4th PS10P Gp</u>	COL Taro Katagiri
		<u>34th Gen Spt Gp</u>	COL Samuel G. Cockerham
		<u>507th Trans Gp</u>	COL Henry H. Boltz, Jr.
		<u>509th Radio Rsch Gp</u>	COL William W. Higgins
		<u>525th MI Gp</u>	COL William H. Patterson

PRINCIPAL COMMANDERS OF FREE WORLD MILITARY FORCES

<u>Australian Army Volunteer Force, RVN</u> 1st Australian Task Force, RVN 6th Bn 5th Bn 9th Bn	MG R. A. Hay BRIG S. R. Kerr LTC D. Butler LTC C. M. Khan LTC E. R. Philip	<u>New Zealand Army Forces, RVN</u>	LTC K. C. Fenton
<u>Republic of Korea Forces, RVN</u> ROK Capital Div ROK 9th Div 2d ROK Marine Bde	LTG Yi, Se-ho MG Yun, Pil-yong MG Yun, Chang-hun MG Yi, Tong Ho	<u>Royal Thai Forces, RVN</u> Royal Thai Army Vol Force, RVN 1st Bde 2d Bde	LTG Chaveng Youngcharoen MG Swasdi Nakkaron SP COL Naronkrit Maharakkhara SP COL Aroon Tamatasin

1/ Attached to 1st Fld, 5th Mech per USARV GO 1836 2800 69; current by DPMOS 101st Abn Div.

UNCLASSIFIED

DATE FOR REMOVAL OF PROTECTIVE
MARKINGS CANNOT BE PREDETERMINED.

SELECTED ADVISORS IN RVN

CORDS ADVISORS

26 FEBRUARY 1970

UNCLASSIFIED

I CTZ
Senior Advisor
DEPCORDS
Quang Nam
Quang Ngai
Quang Tin
Quang Tri
Thue Thien

LTC Herman Nickerson, Jr., USMC **
Mr. Alexander Fivier
LTC William A. Blakely
LTC Richard A. Hippler (P)
LTC Mahane G. Stafford
LTC Elmer L. Birk (P)
COL John W. Olson

II CTZ
Senior Advisor
DEPCORDS
Binh Dinh
Binh Thuan
Darlac
Khanh Hoa
Kon Tum
Lam Dong
Ninh Thuan
Phu Bon
Phu Yen
Pleiku
Quang Duc
Tuyen Duc

LTC Charles A. Corcoran **
Mr. James Megellas
COL Billy J. Mendheim
LTC Carleton J. Robinson
LTC Timothy C. Cannon
LTC Frederick L. Hegley
COL Oliver W. Dillard
COL Laurence D. Thompson
LTC Lewis H. Nam, Jr.
LTC Robert R. Nicks (P)
LTC Thomas M. Silvers
COL Carl A. Lee
LTC Ralph W. Julian
LTC Paul R. Hilty, Jr.

III CTZ
Senior Advisor
DEPCORDS
Bien Hoa
Binh Duong
Binh Long
Binh Tuy
Gia Dinh
Hau Nghia
Long An
Long Khanh
Phuoc Long
Phuoc Tuy
Tay Ninh

LTC Julian J. Ewell **
Mr. Charles S. Whitehouse
LTC Kenneth T. Trinkler
LTC Raymond L. Fleigh, Jr.
LTC Robert A. Farr
LTC Richard C. Ewan, Jr.
COL Roy W. Burley
COL Jack E. Weissinger
COL Alfred L. Sanderson
LTC Joseph J. Scott, Jr. (P)
LTC Robert T. Hayden
LTC John J. Bacci
LTC James C. Cloud (P)

IV CTZ
CG, Delta Mil Asst Comd
DEPCORDS
An Giang
An Suyen
Ba Suyen
Bac Lieu
Chau Doc
Chuong Thien
Dinh Tuong
Go Cong
Kien Giang
Kien Hoa
Kien Phong
Kien Tuong
Phong Dinh
Sa Dec
Vinh Binh
Vinh Long

MG Hal D. McCown
Mr. John P. Vann
LTC Warren P. Schilling (P)
LTC Donald E. Sawyer
LTC Edward E. Matney
COL Bert H. Herigstad
LTC Horace L. Hunter, Jr.
LTC Thomas Le Vasseur
COL Joy E. Vallery
LTC John D. Howard (P)
LTC Edward P. Motzner
LTC Neil J. Eckhart
LTC Clement H. Will (P)
COL Ernest P. Terrell, Jr.
COL Lester M. Conger
LTC Lynn L. Lee
COL Richard W. Ellison
LTC Roland D. Fausch

ARVN ADVISORS

I Corps
Dep Senior Advisor
1st Div
2d Div
Quang Da STZ

SG Henry J. Muller, Jr.
COL Jesse L. Wheeler, Jr.
COL Henry S. Sachers
COL Warren P. Allen

II Corps
Dep Senior Advisor
22d Div
23d Div
24th STZ

SG Gordon J. Duquemin
COL Sam L. Barth 1/
COL William Zook
COL Phillip S. Day, Jr.

III Corps
Dep Senior Advisor
5th Div
18th Div
25th Div

SG Dennis P. McAuliffe
COL John C. Hayes
COL John E. Tyler
COL George B. Robbins

IV Corps (CG, Delta Mil Asst Comd)
Deputy Senior Advisor (DCG, TMAC)
7th Div
9th Div
21st Div
44th STZ

MG Hal D. McCown
SG George G. Cantlay
COL William B. McGraf
COL James W. Cavender
COL Louis F. Felder
COL Robert M. Hassinger

Capital Military District
MCD, Capital Military District

Vacant
COL Byron D. Greene, Jr. (Actg)

Abn Div

Colonel Charles F. Greer

* Member Province Senior/Deputy Senior Advisor Program.
** The Senior US military officer in each Corps Tactical Zone is also the Senior Advisor for both CORDS and ARVN functions. The CG, Delta Mil Asst Comd is the Senior Advisor in the IV CTZ.
1/ Indicates province in which the military advisor is also the Province Senior Advisor.
1/ COL Barth was erroneously reported as Senior Advisor 5th ARVN Div in the 11 Feb issue.

DATE FOR REMOVAL OF PROTECTIVE MARKINGS CANNOT BE DETERMINED.

RESTRICTED USE ONLY

26-5

UNCLASSIFIED

Unclassified

UNCLASSIFIED

DEPLOYMENTS AND REDEPLOYMENTS

26 FEBRUARY 1970

LISTING OF SELECTED UNITS IN RVN

(INCLUDES INF, ARM, ARTY, AND AVIATION; AND UNITS OF BN OR LARGER SIZE OF ENGR, MP, AND SIG)

UNIT	ACTIV DATE	CLOSED IN RVN	UNIT	ACTIV DATE	CLOSED IN RVN
HQ FFV/CORPS			101st Abn Div (Ambl) (Cont)		
1 FFV (Nha Trang)	Nov 65	V	2d Bde (Van Xe)		
11 FFV (Long Binh)	Jan 66	Mar 66	17501 Inf (Ambl)	*	Dec 67
XXIV Corps (Phu Bai)	Aug 68**	V	27501 Inf (Ambl)	*	Dec 67
			17502 Inf (Ambl)	*	Dec 67
DIVISIONS			3d Bde (Phong Dien)		
1st Inf Div (Lai Khe)	*		37187 Inf (Ambl)	*	Dec 67
1st Bde (Dau Tieng)			17506 Inf (Ambl)	*	Dec 67
172 Inf		Oct 65	27506 Inf (Ambl)	*	Dec 67
1728 Inf		Oct 65			
2728 Inf		Oct 65	2717 Cav (Ambl)	Jul 68	Dec 67 ^{1/}
272 Inf (Mech)		Oct 65	27319 Arty (105 T) (Ambl)	*	Dec 67
			27320 Arty (105 T) (Ambl)	*	Jul 65
2d Bde (Bear Cat)			17321 Arty (105 T) (Ambl)	*	Dec 67
1716 Inf (Mech)	*	Oct 65	326 Engr Bn (Ambl)	*	Nov 67
2716 Inf		Jul 65	501 Sig Bn (Ambl) (-)	*	Dec 67
2718 Inf		Jul 65	2711 Arty (155 T)	*	Dec 66
			4777 Arty (ARA)	Jul 68	Dec 68
3d Bde (Di An)					
1718 Inf		Jul 65	101st Avn Gp (Phu Bai) 2/	Jul 68	V
1726 Inf		Oct 65	101 Avn Bn (Ambl) (3AvnCos, 1WpnCo)	Jul 68	V
			159 Avn Bn (Ambl) (3 Avn Cos)	Jul 68	V
174 Cav		Oct 65	163 Avn Co (GS) (Ambl)	Jul 68	Feb 69
175 Arty (105 T)		Oct 65	158 Avn Bn (Asit Hel) (3 Avn Cos, 1WpnCo)	Jul 68	
876 Arty (155/8" T)		Oct 65			
177 Arty (105 T)		Jul 65	23d Inf Div (Chu Lai)	Sep 67	V
2733 Arty (105 T)		Oct 65	11th Inf Bde (Duc Pho)		
173 Avn Co (Ambl) (Lt) (Atchd)	Sep 65	Mar 66	371 Inf	Jul 66	Dec 67
1 Avn Bn (w/2 Avn Cos)		Oct 65	473 Inf	Jul 66	Dec 67
1 Engr Bn		Nov 65	1720 Inf	Jul 66	Dec 67
121 Sig Bn		Oct 65	4721 Inf	Nov 67	Apr 68
			E71 Cav	Jul 66	Dec 67
4th Inf Div (Pleiku)	*				
1st Bde (An Khe)			196th Inf Bde (Chu Lai/Tuan Duong)		
178 Inf		Oct 66	271 Inf	Sep 65	Aug 66
378 Inf		Oct 66	3721 Inf	Sep 65	Aug 66
1714 Inf		Jan 66	4731 Inf	Sep 65	Aug 66
1722 Inf		Aug 66	F717 Cav	Sep 65	Aug 66
2d Bde (An Khe)			198th Inf Bde (Chu Lai/Dong Le)		
1712 Inf		Aug 66	176 Inf	*	Oct 67
1735 Inf		Jan 66	1746 Inf	*	Oct 67
2735 Inf		Jan 66	5746 Inf	Oct 67	Mar 68
			1752 Inf	*	Oct 67
3d Bde (Pleiku)			H717 Cav	May 67	Oct 67
278 Inf (Mech)		Aug 66			
3712 Inf		Oct 66	6711 Arty (105 T)	Mar 67	Dec 67
			3782 Arty (105 T)	Sep 65	Aug 66
1710 Cav		Oct 66	1714 Arty (105 T)	*	Oct 67
1769 Arm		Mar 66	1782 Arty (155/8" SP)	Jan 68	Jul 68
279 Arty (105 T)		Jan 66	3716 Arty (155 T)	*	Jun 67
5716 Arty (155/8" SP)		Oct 66	3718 Arty (175/8" SP)	*	Oct 65
6729 Arty (105 T)		Oct 66	123 Avn Bn	Dec 67	V
			26 Engr Bn	Dec 67	V
4742 Arty (105 T)		Aug 66	523 Sig Bn	Jan 68	V
4 Avn Bn (w/2 Avn Cos)		Sep 66/Jan 67	F78 Cav	Apr 68	V
4 Engr Bn		Jul 66			
124 Sig Bn		Sep 66	25th Inf Div (Cu Chi)	*	
			1st Bde (Tay Ninh)		
101st Abn Div (Ambl) (Hue-Phu Bai)	*		479 Inf	Nov 65	Apr 66
1st Bde (Hue-Phu Bai)			3722 Inf		Oct 66
17327 Inf (Ambl)	*	Jul 65	4723 Inf (Mech)		Apr 66
27327 Inf (Ambl)	*	Jul 65			
27502 Inf (Ambl)	*	Jul 65	2d Bde (Cu Chi/Dau Tieng)		
37506 Inf (Ambl) (Op Con 173d Abn Bde)	Apr 67	Oct 67	1775 Inf (Mech)		Jan 66
			2712 Inf	*	Oct 66
			2727 Inf		Jan 66

V Activated in-country.

* In the force structure prior to 30 Jun 65.

** Succeeded Provisional Corps, RVN, which was activated in Mar 68.

NOTE: Location shown to the left of the slash is the unit's base camp; where the base camp location differs from the field command post location, the command post location is shown to the right of the slash. Organization of battalions within brigades shown is administrative.

1/ The 2717 Cav (Abn) closed RVN Dec 67; 2717 Cav (Ambl) was activated in RVN effective 1 Jul 69; troops A, B, and C/Air Cav closed RVN Mar 69.

2/ Redesignated 101st Avn Gp on 24 Jun 69.

DOWNGRADED AT 5 YEAR INTERVALS
DECLASSIFIED AFTER 10 YEARS
DOD DIR 5200.10

26-6



Unclassified

UNCLASSIFIED
DEPLOYMENTS AND REDEPLOYMENTS

16 FEBRUARY 1970

NO CHANGE

NO CHANGE

LISTING OF SELECTED UNITS IN RVN

(INCLUDES INF, ARM, ARTY, AND AVIATION; AND UNITS OF BN OR LARGER SIZE OF BRON, MP, AND SIG)

UNIT	ACTIV DATE	CLOSED IN RVN	UNIT	ACTIV DATE	CLOSED IN RVN
<u>25th Inf Div (Cont)</u>					
<u>3d Bde (Cu Chi/Bao Trai)</u>					
2/14 Inf	*	Apr 66			
2/22 Inf (Mech)	*	Oct 66			
1/27 Inf	*	Jan 66			
3/4 Cav	*	Mar 66			
2/34 Arm	*	Sep 66			
1/8 Arty (105 T)	*	Jan 66			
7/11 Arty (105 T)	*	May 66			
3/13 Arty (155/8" T)	*	Apr 66			
2/77 Arty (105 T)	*	Oct 66			
25 Avn Bn (w/2 Avn Cos)	*	Apr 66			
65 Engr Bn	*	Jan 66			
125 Sig Bn	*	Mar 66			
<u>1st Cav Div (Ambl)(Bien Hoa/Phuoc Vinh)</u>	*				
<u>1st Bde (Tay Ninh)</u>					
2/77 Cav (Ambl)	*	Sep 65			
2/5 Cav (Ambl)	*	Sep 65			
2/8 Cav (Ambl)	*	Sep 65			
<u>2d Bde (Bien Hoa/Phuoc Vinh)</u>					
2/12 Cav (Ambl)		Jul 65			Sep 65
5/7 Cav (Ambl)	*	Apr 66			Aug 66
1/12 Cav (Ambl)	*				Sep 65
<u>3d Bde (Quan Loi)</u>					
1/5 Cav (Ambl)	*	Sep 65			Sep 66
1/7 Cav (Ambl)	*	Sep 65			Sep 66
1/8 Cav (Ambl)	*	Sep 65			Sep 66
<u>11th Avn Gp (Bien Hoa/Phuoc Vinh)</u>					
227 Avn Bn (Ambl) (4 Avn Cos)	*	Sep 65			
228 Avn Bn (Ambl) (3 Avn Cos)	*	Sep 65			
229 Avn Bn (Ambl) (4 Avn Cos)	*	Sep 65			
11 Avn Co (GS) (Ambl)	*	Sep 65			
478 Avn Co (Hvy Hel) (Atchd)	*	Sep 65			
1/9 Air Cav Sqn	*	Sep 65			
2/19 Arty (105 T) (Ambl)	*	Oct 65			
2/20 Arty (Aer Rkt) (Ambl)	*	Oct 65			
1/21 Arty (105 T) (Ambl)	*	Oct 65			
1/77 Arty (105 T) (Ambl)	*	Oct 65			
1/30 Arty (155 T)	*	Nov 65			
E/82 Arty (Ambl)	*	Oct 65			
8 Engr Bn (Ambl)	*	Sep 65			
13 Sig Bn (Ambl)	*	Sep 65			
<u>BRIGADES</u>					
<u>1st Bde 5th Inf Div (Mech)(Quang Tri)</u>	*				
1/11 Inf		Jul 68			
1/61 Inf (Mech)		Jul 68			
1/77 Arm		Jul 68			
5/4 Arty (155 SP)		Jul 68			
A/7 Engr Bn		Jul 68			
A/4/12 Armed Cav		Jul 68			
3/5 Cav (-)	Feb 66	Jan 67			
<u>199th Inf Bde (Long Binh/Xuan Loc)</u>					
2/3 Inf	Jun 66	Dec 66			
3/7 Inf	Jun 66	Dec 66			
4/12 Inf	Nov 67	Dec 66			
5/12 Inf	Jun 66	Dec 66			
2/40 Arty (105 T)	Jun 66	Dec 66			
D/17 Cav					
			<u>BRIGADES (Cont)</u>		
			<u>173d Abn Bde (Bong Son)</u>		
			1/503 Abn Inf	*	May 65
			2/503 Abn Inf	*	May 65
			3/503 Abn Inf	Apr 67	Oct 67
			4/503 Abn Inf	Apr 66	Jun 66
			3/506 Inf (Ambl) (Op Con 173d Abn Bde)	Apr 67	Oct 67
			3/319 Arty (105 T)	*	May 65
			D/16 Arm	*	May 65
			E/17 Cav	*	May 65
			<u>3d Bde 9th Inf Div (Tan An) 1/</u>		
			6/31 Inf	Nov 67	Apr 68
			2/47 Inf (Mech)	Feb 66	Jan 67
			2/60 Inf	Feb 66	Dec 66
			5/60 Inf	Feb 66	Dec 66
			2/4 Arty (105 T)	Feb 66	Jan 67
			B/17 Cav	Jun 66	Dec 66
			<u>ARMORED CAVALRY REGIMENTS</u>		
			<u>11th Arm Cav Regt 2/ (Bien Hoa/Quan Loi)</u>	*	
			1st Sqn		Sep 66
			2d Sqn		Sep 66
			3d Sqn		Sep 66
			<u>SPECIAL FORCES GROUPS</u>		
			5th SF Gp, 1st SF (Nha Trang)	*	Apr 65
			<u>ARMED CAVALRY SQUADRONS</u>		
			1/1 Cav (Chu Lai) (Op Con 23d Inf Div)	*	Aug 67
			2/1 Cav (Song Mao) (Op Con TF South)	*	Aug 67
			3/5 Cav 3/	Feb 66	Jan 67
			<u>SEPARATE INFANTRY BATTALIONS</u>		
			1/50 Inf (Mech) (Phan Thiet) (Op Con 1 FFV TF South)	*	Sep 67
			TF South (Phan Thiet)	Jul 68	

V Activated in-country
 * In the force structure prior to 30 Jun 65.
 1/ Op Con 25th Inf Div effective 26 Jul 69.
 2/ Op Con to the 1st Cav Div.
 3/ Attached to 1st Bde, 5th Mech per USARV GO 1836, 21 May 69.

NOTE: Location shown to the left of the slash is the unit's base camp; where the base camp location differs from the field command post locations, the command post location is shown to the right of the slash. Organization of battalions within the brigades shown is administrative.

DOWNGRADED AT 1 YEAR INTERVALS
DECLASSIFIED AFTER 11 YEARS
DOD DIR 89N.18

SECRET

26-7

UNCLASSIFIED

Unclassified

UNCLASSIFIED

26 FEBRUARY 1970

NO CHANGE

DEPLOYMENTS AND REDEPLOYMENTS

NO CHANGE

LISTING OF SELECTED UNITS IN RVN

(INCLUDES INF, ARM, ARTY, AND AVIATION; AND UNITS OF BN OR LARGER SIZE OF ENGR, MP, AND SIG)

UNIT	ACTIV DATE	CLOSED IN RVN	UNIT	ACTIV DATE	CLOSED IN RVN
COMBAT SUPPORT UNITS:			237 Engr Gp (Cbt) (Pleiku)		
<u>Field Artillery</u>			19 Engr Bn (Cbt)		
1 FFV Arty (Nha Trang)	Aug 65	Nov 65	20 Engr Bn (Cbt)	*	Jan 66
52 Arty Gp (Pleiku)	*	Jun 66	299 Engr Bn (Cbt)	*	Oct 65
1 FFV Prov Arty Gp	Apr 69	V	84 Engr Bn (Const)	*	Jun 65
3/6 Arty (105 SP)	*	Jun 66	815 Engr Bn (Const)	Feb 66	Apr 67
7/13 Arty (105 T)	Jun 66	Oct 66	20 Engr Bde (Bien Hoa)		
6/14 Arty (175 SP)	*	Oct 65	34 Engr Gp (Const) (Binh Thuy)		
7/15 Arty (8" SP)	*	Jul 67	35 Engr Bn (Cbt)		
2/17 Arty (105 T)	*	Sep 65	36 Engr Bn (Const)		
5/22 Arty (175 SP)	May 67	Dec 67	69 Engr Bn (Const)		
5/27 Arty (105 T)	*	Oct 65	93 Engr Bn (Const)		
6/32 Arty (8" SP)	*	Mar 67	79 Engr Gp (Const) (Long Binh)		
1/92 Arty (155 T)	*	Mar 67	168 Engr Bn (Cbt)		
			588 Engr Bn (Cbt)		
11 FFV Arty (Long Binh)	Jan 66	Mar 66	34 Engr Bn (Const)		
23 Arty Gp (Phu Loi)	*	*	554 Engr Bn (Const)		
7/8 Arty (8" SP)	*	Jun 67	159 Engr Gp (Const) (Long Binh)		
7/9 Arty (105 T)	*	Oct 66	31 Engr Bn (Cbt)		
2/12 Arty (155 T)	Sep 69	V	46 Engr Bn (Const)		
2/13 Arty (105 T)	*	Oct 65	62 Engr Bn (Const)		
1/27 Arty (155 SP)	Oct 66	Apr 67	92 Engr Bn (Const)		
6/27 Arty (8" SP)	*	Nov 65	169 Engr Bn (Const)		
2/32 Arty (175 SP)	*	Nov 65	US Army Engr Const Agency RVN (Long Binh)		
2/35 Arty (155 SP)	*	Jun 66	May 68		
5/42 Arty (155 T)	Jan 67	Apr 68	Signal		
F/16 Arty (155 T)	*	V	1st Sig Bde (USASTRATCOM) (Long Binh)		
			2d Sig Gp (Long Binh)		
XXIV Corps Arty (Phu Bai)	Aug 68**	V	36 Sig Bn (Cbt Area)		
108 Arty Gp (Dong Ha)	May 67	Oct 67	39 Sig Bn (Spt)		
8/4 Arty (175/8" SP)	Aug 67	Aug 67	52 Sig Bn (Spt)		
1/83 Arty (175/8" SP)	*	Nov 66	86 Sig Bn (Spt)		
2/94 Arty (8" SP)	Jun 66	Oct 66	972 Sig Bn		
6/33 Arty (105 T)	Sep 67	Feb 68	21 Sig Gp (Nha Trang)		
			41 Sig Bn (Cbt Area)		
			43 Sig Bn (Spt)		
			73 Sig Bn (Spt)		
			459 Sig-Bn (Cbt Area)		
			160 Sig Gp (Long Binh)		
			40 Sig Bn (Const)		
			44 Sig Bn (Spt)		
			69 Sig Bn (Army)		
			Regional Comm Gp (Saigon)		
			361st Sig Bn		
			369th Sig Bn		
			USASTRATCOM Fac - Phu Lam		
			USASTRATCOM Fac - Da Nang		
			USASTRATCOM Fac - Nha Trang		
			12 Sig Gp (Phu Bai)		
			37 Sig Bn (Spt)		
			63 Sig Bn (R&C)		
			53 Sig Bn (Long Binh)		
			54 Sig Bn (Nha Trang)		
			Military Police		
			18th MP Bde (Long Binh)		
			16th MP Gp (Nha Trang)		
			93 MP Bn		
			97 MP Bn		
			504 MP Bn		
			45 Engr Gp (Const) (Phu Bai)		
			14 Engr Bn (Cbt)		
			27 Engr Bn (Cbt)		
			39 Engr Bn (Cbt)		

V Activated in-country.
 * In the force structure prior to 30 Jun 65.
 ** Succeeded Provisional Corps Arty RVN, which was activated in Mar 68.

UNCLASSIFIED

UNCLASSIFIED AT 5 YEAR INTERVALS
 DECLASSIFIED AFTER 10 YEARS
 DOD OIR 1000.10

Unclassified

~~UNCLASSIFIED~~

26 FEBRUARY 1970

DEPLOYMENTS AND REDEPLOYMENTS

LISTING OF SELECTED UNITS IN RVN

(INCLUDES INF, ARM, ARTY, AND AVIATION) AND UNITS OF 50 OR LARGER SIZE OF 5000, MP, AND 610)

NO CHANGE

NO CHANGE

UNIT	ACTIV DATE	CLOSED IN RVN	UNIT	ACTIV DATE	CLOSED IN RVN
Military Police (Cont)			Aviation (Cont)		
8th MP Gp (CI) (Long Binh)	Aug 68	V	10th Cmbt Avn Bn (Dong Ba Thin)	Aug 65	Oct 65
89 MP GP (Long Binh)	Mar 66	V	48th Aslt Hel Co (Ninh Hoa)	Jul 65	Nov 65
92 MP Bn	*	Apr 66	92d Aslt Hel Co	Feb 67	Nov 67
95 MP Bn	Nov 65	Apr 66	155th Aslt Hel Co (Ban Me Thuot)	Jul 65	Oct 65
716 MP Bn	*	Mar 65	192d Aslt Hel Co (Phan Thiet)	Nov 66	Oct 67
720 MP Bn	*	Oct 66	243d Aslt Spt Hel Co	Dec 66	Nov 67
			281st Aslt Hel Co (Nha Trang)	Oct 65	Jun 66
Aviation 1/ 2/			52d Cmbt Avn Bn (Pleiku)	*	Mar 63
1st Avn Bde (Long Binh)	May 66	May 66	57th Aslt Hel Co (Kontum)	Feb 67	Oct 67
5th Avn Det	*	Oct 64	119th Aslt Hel Co (An Khe)	*	V
165th Avn Gp (Long Binh)	Feb 69	V	170th Aslt Hel Co	Sep 65	Dec 65
130th Aslt Hel Co	*	Mar 65	179th Aslt Spt Hel Co	Dec 65	Jun 66
125th ATC Co (Bien Hoa)	*	Jul 65	189th Aslt Spt Hel Co	Nov 66	May 67
Comd Acft Co (Long Thanh)	*	V	361st Aerial Wpns Co (Escort) ^{3/}	Nov 67	Apr 68
12th Cmbt Avn Gp (Long Binh)	*	Aug 65	223d Cmbt Avn Bn (Qui Nhon)	May 66	V
11th Cbt Avn Bn (Phu Loi)	Aug 65	Nov 65	18th Util Apl Co (OA)	*	Feb 62
128th Aslt Hel Co	Jul 65	Oct 65	183d Recon Apl Co (Dong Ba Thin)	Jan 66	Jun 66
173d Aslt Hel Co (Lai Khe)	Sep 65	Mar 66	185th Recon Apl Co (Ban Me Thuot)	Jan 67	Jun 67
205th Aslt Spt Hel Co	Nov 66	May 67	203d Recon Apl Co (Phu Nhip)	Apr 67	Oct 67
213th Aslt Spt Hel Co	Jun 66	Jan 67	219th Recon Apl Co (Pleiku)	Mar 65	Jun 65
145th Cmbt Avn Bn (Bien Hoa)	Sep 63	V	225th Surv Apl Co (Phu Nhip)	Jul 66	May 67
68th Aslt Hel Co	Jul 65	Nov 65	268th Cmbt Avn Bn (Phu Nhip)	Feb 67	May 67
118th Aslt Hel Co	*	P	61st Aslt Hel Co (An Son)(Lang)	Jul 67	Nov 67
190th Aslt Hel Co	Oct 66	Aug 67	129th Aslt Hel Co (An Son) AHP	Feb 67	Nov 67
334th Aerial Wpns Co	Nov 66	V	134th Aslt Hel Co	Mar 66	Oct 66
210th Cmbt Avn Bn (Long Thanh)	Feb 67	Apr 67	180th Aslt Hel Co	Jul 65	Mar 67
25th Avn Co (Corps) (Long Binh)	Mar 67	Oct 67	196th Aslt Spt Hel Co (An Son)	Jul 65	Jan 68
54th Util Apl Co (Vung Tau)	Sep 65	Sep 65	355th Hvy Hel Co	Jul 67	Jan 68
73d Surv Apl Co (Vung Tau)	*	May 63	238th Aerial Wpns Co (RD)(An Khe)	Jul 68	Mar 68
74th Recon Apl Co (Phu Loi)	*	Mar 65	7th Sqdn 17th Air Cav (Pleiku)	Nov 66	Oct 67
184th Recon Apl Co (Phu Loi)	Jan 66	Aug 66	164th Cmbt Avn Gp (Can Tho)	Dec 67	V
222d Cmbt Avn Bn (Bear Cat)	May 66	V	13th Cmbt Avn Bn (Soc Trang)	*	Sep 64
117th Aslt Hel Co (Long Binh)	*	Jun 63	121st Aslt Hel Co	Sep 65	Feb 66
195th Aslt Hel Co (Long Binh)	Nov 66	Nov 67	162d Aslt Hel Co (Can Tho)	Dec 66	May 67
240th Aslt Hel Co	Nov 66	May 67	191st Aslt Hel Co (Can Tho)	Mar 65	V
273d Hvy Hel Co (Long Binh)	Apr 67	Dec 67	221st Recon Apl Co	Nov 66	V
269th Cmbt Avn Bn (Cu Chi)	Jul 66	Jan 67	336th Aslt Hel Co		
116th Aslt Hel Co	Jul 65	Oct 65	214th Cmbt Avn Bn (Vinh Long)	*	May 63
187th Aslt Hel Co (Tay Ninh)	Sep 66	Mar 67	114th Aslt Hel Co	Nov 66	Nov 67
242d Aslt Spt Hel Co (Dong Ba Thin)	Oct 66	Aug 67	135th Aslt Hel Co (Bear Cat)	Nov 66	V
3d Sqdn 17th Air Cav (DI An)	Nov 66	Oct 67	175th Aslt Hel Co	Feb 67	Jul 67
16th Cmbt Avn Gp (Chu Lai) ^{2/}	Dec 67	V	199th Recon Apl Co	Nov 66	Nov 66
14th Cmbt Avn Bn (Chu Lai) ^{2/}	*	Oct 64	307th Cmbt Avn Bn (Can Tho)	Dec 67	V
71st Aslt Hel Co	*	Sep 66	147th Aslt Spt Hel Co (Vung Tau)	Jul 65	Nov 65
132d Aslt Spt Hel Co	Oct 67	May 68	235th Aerial Wpns Co	Dec 66	Nov 67
174th Aslt Hel Co (Duc Pho)	Oct 65	Apr 66	244th Surv Apl Co	Sep 66	Jul 67
176th Aslt Hel Co	Oct 65	Feb 67	271st Aslt Spt Hel Co	Apr 67	Feb 68
178th Aslt Spt Hel Co	Sep 65	Mar 66	7th Sqdn 1st Air Cav (Vinh Long)	Nov 66	Oct 67
212th Cmbt Avn Bn (Da Nang)	Mar 67	Jul 67	D/3/5 Cav	Feb 66	Jan 67
21st Recon Apl Co (Chu Lai)	Jan 67	Jun 67	Other Aviation Units		
131st Surv Apl Co (Hue/Phu Bai)	Jul 65	V	224th Avn Bn (RR)(USASA)(Tan Son Nhut)	Jun 66	V
220th Recon Apl Co (Hue/Phu Bai)	*	Jul 65	138 Avn Co (RRU)(Can Tho)	Jun 66	V
245th Surv Apl Co	Sep 66	Oct 67	144 Avn Co (RRU)(Nha Trang)	Jun 66	V
282d Aslt Hel Co	Oct 65	Jun 66	146 Avn Co (RRU)(Tan Son Nhut)	Jun 66	V
62d Corps Avn Co (Hue/Phu Bai)	Mar 68	V	156 Avn Co (RRU)(Can Tho)	Jun 66	V
17th Cmbt Avn Gp (Nha Trang)	Dec 65	V	1 ASA Co (Avn)(Cam Ranh Bay)	*	Jun 67
201st Corps Avn Co	Mar 67	Oct 67	509th Radio Research Group (Salgon)	Jun 66	V

1/ In addition to the aviation companies listed, the following cavalry, artillery, and medical company-sized units are aircraft companies: 3 Air Cav troops of the 1/9 Cav, 1st Cav Div (Aml); Trp D (Air Cav) of the 1/4 Cav, 1st Inf Div; Trp D (Air Cav) of the 3/4 Cav, 25th Inf Div; Trp D (Air Cav) of the 3/5 Cav, 9th Inf Div; Trp D of the 1/10 Cav, 4th Inf Div; Trp D (Air Cav), 1/1 Cav; Trp D (Air Cav), 2/1 Cav; 3 aerial rocket batteries of the 2/20 Arty (Aer Rkt) of the 1st Cav Div (Aml); 3 air Cav troops of the 2/17 Cav, Air Cav Trp, 11th Armd Cav Regt; and two medical companies, Air Ambulance.

2/ Organic aviation companies are shown with major command.

3/ Scheduled for possible TDY missions (Duffle Bag) in Thailand.

* In the force structure prior to 30 Jun 65.

P Prior to Mar 65, exact date unknown.

V Activated in-country.

DOWNGRADED AT 5 YEAR INTERVALS
DECLASSIFIED AFTER 12 YEARS
DDC DIR 588.10

26-9
UNCLASSIFIED

Unclassified

~~SECRET~~

MARINE CORPS COMMAND CENTER

UNCLASSIFIED US NAVY UNITS IN I CTZ

26 FEBRUARY 1970

	QUANG TRI	THUA THIEN	QUANG NAM	QUANG TIN	QUANG NGAI
NAVAL SUPPORT ACTIVITY	792	592	7,511	728	70
3D NAV CONST BDE			207		
30TH NAV CONST REGT.			14		
MCB-121			748		
MCB-7				750	
32D NAV CONST REGT		30			
MCB- 1		755			
MCB- 74	748				
MCB- 10		750			
OTHER UNITS & DETACHMENT	88	100	815	107	
AREA TOTALS	1,628	2,227	9,295	1,585	70

SOURCE: COMNAVFORV MONTHLY STRENGTH REPORT FOR THE PERIOD ENDING 2400H, 29JAN70.

NOTE: FIGURES DO NOT INCLUDE USN ORGANIC TO III MAF MARINE UNITS.

I CTZ TOTAL: 14,805

MCB = Mobile Construction Battalion
ACB = Amphibious " "
NMCB = same as MCB

Unclassified
UNCLASSIFIED

~~SECRET~~

~~CONFIDENTIAL~~

UNCLASSIFIED

MARINE CORPS COMMAND CENTER

SELECTED PERSONNEL AND AIRCRAFT DATA

PERSONNEL

27 FEBRUARY 1970

	STRENGTH	PERCENT USMC	PERCENT FMF	PERCENT FMFPAC
USMC TOTAL	301,675 *	100.00		
FLEET MARINE FORCES	153,295	50.81	100.00	
FMF ATLANTIC	45,696 \$	15.14	29.81	
FMF PACIFIC	107,599 #	35.66	70.19	
VIETNAM	51,878 †	17.23	34.21	48.74

SOURCE: * MONTHLY USMC PERSONNEL ALLOCATION REPORT OF 31DEC69.
 \$ MCCC UNIT REPORT OF 12FEB70.
 # MCCC UNIT REPORT OF 4FEB70.
 † MACV WEEKLY STRENGTH REPORT AS OF 2400, 19FEB70 AS ADJUSTED BY THE MACV DAILY RPT OF ARR/DEP AS OF 2400, 25FEB70.

AIRCRAFT

25 FEBRUARY 1970

	FIXW	HELO	TOTAL	PERCENT USMC	PERCENT FMF	PERCENT FMFPAC
USMC TOTALS	1013	569	1582	100.00		
FLEET MARINE FORCES	756	563	1319	83.37	100.00	
FMF ATLANTIC	293	162	455	28.76	34.49	
FMF PACIFIC	463	401	864	54.61	65.50	
VIETNAM	156	168	324	20.48	24.56	37.50

SOURCE: MARINE CORPS COMMAND CENTER UNIT REPORT OF 18FEB70.

UNCLASSIFIED
Unclassified

~~CONFIDENTIAL~~

~~CONFIDENTIAL~~
UNCLASSIFIED

FLEET MARINE FORCE DEPLOYMENTS

27 FEBRUARY 1970



1ST MAR BRIG
HAWAII

10TH MARINES
DET, 2D FAG
DET 1, HMM-264
AT VIEQUES FOR FIREX,
ETD 25MAR70 FOR
CAMLEJ.

GTMO AUGMENT
2D BN, 8TH MAR
BTRY B/1/10
PLT, 2D TK BN
PLT, 2D ANGLICO
DET, FSR

LANFORCARIB 1-70
BLT 3/2 & HMM-261
ENR GTMO
ETA 27FEB70

LANFOR6THFLT 3-69
AT ATHENS

III MAF
RVN

SLF, 7TH FLEET
SLF ALFA
AT OKINAWA
SLF BRAVO
AT SUBIC

I MEF
OKINAWA
& JAPAN
DET, 12THMAR, "D" CO,
3D RECON BN AT FUJI
FOR TRNG.

DISTRIBUTION OF MAJOR FMF UNITS

	INF BNS	VMFA	YMA	YMA(AW)	VMCJ	HMM	FMH	HML	YMO	VMGR
WESTPAC	18	5	2	3	1	6	2	2	2	1
RVN	(12)	(3)	(1)	(2)	(1)	(4)	(1)	(2)	(2)	
OKINAWA/JAPAN	(4)	(2)	(1)*	(1)			(1)		(1)	(1)
ASSIGNED TO SLF'S	(2)					(2)				
MIDPAC	1	2								
HAWAII AFLOAT	(1)	(2)								
EASTPAC	2	**3	2		1	2	2	1		1
WEST COAST AFLOAT	(2)	(3)	(2)		(1)	(2)	(2)	(1)		(1)
ATLANTIC	8	5	2	3	1	4	2		1	1
EAST COAST CARIBBEAN	(6) (2)	(5)	(2)	(3)	(1)	(3) (1)	(2)		(1)	(1)
EUROPE	1									
MEDITERRANEAN	(1)									
GRAND TOTAL	30	15	6	6	3	12	6	3	3	3

* ENROUTE IWAKUNI.
** VMFA-323 IN CADRE STATUS.

~~CONFIDENTIAL~~
UNCLASSIFIED
Unclassified

UNCLASSIFIED

MARINE CORPS COMMAND CENTER

5TH MARINE EXPEDITIONARY BRIGADE

READINESS SUMMARY

27 FEBRUARY 1970

UNIT	*REPORT DATE	STRENGTH		COMBAT READINESS							
		USMC	USN	RATING	REASON	P	S	E	T	RATING	DATE
5TH MEB				C2	T	1	1	1	2	C1	700430
H&SCO (-) (REIN)		1393	27	C1		1	1	1	1		
3D MARINES (-)				C2	P	2	1	1	2	C1	70027R
HQS CO (-)		289	9	C1		1	1	2	1		
2nd BN		1081	56	C3	T	3	1	1	3	C1	700801
3rd BN		1086	55	C2	P	2	1	1	2	C3	700215
1ST BN, 12TH MARINES (-)		1095	21	C1	X	1	1	1	1		
"A" CO, 3D AT BN (-)		94	7	C2	T	1	1	1	2	C1	700301
"A" CO, 3D RECON BN (-)		92	5	C3	R	1	1	3	1	C2	700331
"C" CO, 3D MED BN (-)		78	53	C2	P	2	1	1	2	C1	700228
"B" CO, 3D ENGR BN (-)		155	1	C1		1	1	2	1	C1	700331
"B" CO, 3D MT BN (-)		76	1	C2	T	1	1	1	2	C1	700730
"B" CO, 3D SP BN (-)		133	16	C1		1	1	1	1		
"D" CO, 3D TANK BN (REIN)		197	7	C2	T	1	1	1	2	C1	700301
DET, 3D SERVICE BN		911	18	C1		1	1	1	1		
7TH MT BN		366	10	C4	X	4	1	1	4	C1	700420
REINFORCING UNITS											
COMM SPT CO, 9TH COMM BN		268		C1		1	1	1	1		
"B" CO, 11TH ENGR (REIN)		252	2	C1		1	1	1	1		
"B" CO, 9TH MT BN (REIN)		159	1	C1		1	1	1	1		
"A" CO, 1ST AMTRAC BN (-)		218	4	C2		2	1	1	2	C1	
13TH ITT		15		C4		4	1	1	4	C3	700228
9TH SSCT		6		C1		1	1	1	1		
13TH CIT		29		C1		1	1	1	1		
1ST SEARCHLIGHT BTRY				C4	N	4	4	4	4	C4	700601
9TH SEP BULK FUEL CO		356		C2	P	2	1	2	2	C1	700315
DET, 5TH DENTAL CO		16		C1		1	1	1	1		
3D BRIDGE CO (-)		141	1	C2	T	1	1	1	2	C1	700228
3D HOSPITAL CO		36	63	C2	P	2	1	1	2	C1	700601
1ST AMRD AMPHIB CO (-)		88		C4	S	1	4	4	4	C3	700601
1ST CIVIL AFFAIRS GROUP		74	4	C3	T	3	1	1	3	C2	700302
21ST ITT		8		C4	P	4	1	1	4	C3	700131

READINESS CATEGORIES

- C-1 Fully Combat Ready
- C-2 Substantially Combat Ready
- C-3 Marginally Combat Ready
- C-4 Not Combat Ready

READINESS ABBREVIATIONS

- P Personnel Readiness
- S Supplies/Equipment on Hand
- E Equipment Readiness
- T Training Readiness
- X Commanders Subjective Judgement-Elaborated by remarks
- N Resource allocation by cognizant service does not permit a higher C-rating

NOTE: Readiness Category Information extracted from SMU REPORT DATES 22FEB70.
Strength Category Information extracted from MCCC Report dated 12FEB70.

UNCLASSIFIED

~~SECRET~~

UNCLASSIFIED

MARINE CORPS COMMAND CENTER

MARINE CORPS PERSONNEL IN RVN

27 FEBRUARY 1970

	OFF	ENL	TOTAL
* III MAF.	3,421	48,148	51,569
DANANG	(2,990)	(41,751)	(44,741)
CHU LAI	(376)	(4,854)	(5,230)
PHU BAI	(21)	(860)	(881)
DONG HA	(34)	(683)	(717)
SU #1, 1ST ANGLICO (AT VARIOUS LOCATIONS SVN)	((21))	((194))	((215))
OTHER USMC PERSONNEL	159	150	309
MACV STAFF/MACV FIELD	(136)	(137)	(273)
NAVAVGRU/NAVY UNITS	(23)	(13)	(36)
USMC IN RVN CHARGED AGAINST PROGRAM VIII	3,580	48,298	51,878
U. S. NAVY, III MAF.	255	1,762	2,017

* AS REPORTED BY III MAF DAILY ADMIN SITREP # 49 AS OF 2400, 17FEB70 AND THE MACV WEEKLY STRENGTH REPORT, AS OF 2400, 19FEB70 AS ADJUSTED BY MACV DAILY RPT OF ARR/DEP AS OF 2400, 25FEB70

Unclassified

UNCLASSIFIED

~~SECRET~~

WESTPAC UNIT LOCATIONS

27 FEBRUARY 1970

QUANG TRI
(QUANG TRI)

1ST BDE, 5TH INF DIV (MECH)
1/77 ARMOR (OPN GREENE RIVER)
1/61 INF (MECH) (OPN GREENE RIVER)
1/11 INF (OPN GREENE RIVER)
3/5 ARMD CAV SQDN (OPN GREENE RIVER)

USMC 717
USN 36 *
USA 8,807

THUA THIEN

HQ, XXIV CORPS (PHU BAI)
HQ, 101st ABN DIV (AM)

1ST BDE, 101ST ABN DIV (AM)
1/327 INF (AM) (OPN RANDOLPH GLEN)
2/327 INF (AM) (OPN RANDOLPH GLEN)
2/502 INF (AM) (OPN RANDOLPH GLEN)

2D BDE, 101ST ABN DIV (AM)
1/501 INF (AM) (OPN RANDOLPH GLEN)
2/501 INF (AM) (OPN RANDOLPH GLEN)
1/502 INF (AM) (OPN RANDOLPH GLEN)

3D BDE, 101ST ABN DIV (AM)
1/506 INF (AM) (OPN RANDOLPH GLEN)
2/506 INF (AM) (OPN RANDOLPH GLEN)
3/187 INF (AM) (OPN RANDOLPH GLEN)

USMC 881
USN 46 *
USA 23,265

QUANG NAM

HQS 1ST MAR DIV (DANANG)

1ST MARINES
1/1
2/1
3/1

5TH MARINES
1/5
2/5
3/5

7TH MARINES
1/7
2/7
3/7

26TH MARINES
1/26
2/26
3/26

HQS, III MAF

USMC 44,741
USN 1,819 *
USA 1,104
ROKMC 6,115

HQ 1st MAW
MAG-11

VMA(AW)-242 (A-6A)
VMA(AW)-225 (A-6A)
VMCJ-1 (RF-4/EA-6/EF-10)
VMO-2 (OV-10A)

MAG-16
HML-367 (AH-1G)
HML-167 (UH-1E)
HMH-463 (CH-53A)
HMM-364 (CH-46D)
HMM-263 (CH-46D)
HMM-262 (CH-46D)
HMM-161 (CH-46)

2d ROKMC BDE

1/2 (OPN VICTORY DRAGON XIX)
2/2 (OPN VICTORY DRAGON XIX)
3/2 (OPN VICTORY DRAGON XIX)
5/2 (OPN VICTORY DRAGON XIX)

FLC 1ST FSR/FLSG-B/1ST SERV BN

QUANG TIN/QUANG NGAI

HQ 23d INF DIV (AMERICAL) (CHU LAI)

196TH LT INF BDE
2/1 INF (OPN FREDERICK HILL)
4/31 INF (OPN FREDERICK HILL)
3/21 INF (OPN FREDERICK HILL)
1/46 INF

198TH LT INF BDE
1/6 INF (OPN GENEVA PARK)
1/52 INF (OPN GENEVA PARK)
5/46 INF (OPN NANTUCKET BEACH)

11TH INF BDE
1/20 INF (OPN IRON MOUNTAIN)
4/21 INF (OPN IRON MOUNTAIN)
3/1 INF (OPN IRON MOUNTAIN)
4/3 INF (OPN IRON MOUNTAIN)
1/1 ARMD CAV SQDN (OPN IRON MOUNTAIN)

1st MAW

MAG-12

MAG-13
VMFA-115 (F-4B)
VMFA-314 (F-4B)
VMFA-122 (F-4B)
VMA-311 (A-4E)

USMC 5,230
USN 116 *
USA 24,430

OKINAWA

HQ, I MEF
3D MARDIV (-)(REIN)(TF-79)
11th MEB (TF-79.1)

4TH MARINES 1/4
2/4
3/4

9TH MARINES 3/9

OSD PROGRAM VIII CEILING 19,200 934
ACTUALS CHARGED AGAINST PROGRAM VIII AS OF 26FEB70. 18,387 424

MAG-36 (13,888) (349)
VMGR-152 (KC-130F)
VMO-6 (OV-10A/UH-1E)
HMH-462 (CH-53A)

3D FSR (3,459) (50)
MCB CAMP BUTLER/NON FMF (932) (25)
Non-Deployable Casuals (1)
SVN-Originated Patients

USMC RVN RECAP

	USMC	USN
OSD PROGRAM IX CEILING EFFECTIVE 15APR70.....	42,610	1,811
OSD PROGRAM VIII CIELING..	55,510	2,233
PROGRAM VIII AS OF 25FEB70..	51,878	2,017
III MAF.....	51,569	2,017
SU#1 1ST ANGLICO.....	(215)	(12)
OTHER.....	309	
MACV STAFF/MACV FIELD..	(273)	
NAVAVGRU/NAVY UNITS..	(36)	

I CORPS RECAP

US MARINE CORPS... (12 BNs)	51,569
US ARMY... (25 BNs)	73,849
US NAVY	16,822
US AIR FORCE	8,194
ROKMC... (4 BNs)	6,115
RVNAF... (36 BNs)	153,895
ARVN/ABN... (36 BNs)	(74,634)
VNMC	
VNN	(2,100)
VNAF	(3,408)
VNRF	(37,403)
VNPF	(36,350)
I CORPS TOTAL ... 77 BN	310,444

SLF 7TH FLEET

	USMC	USN
BRAVO: BLT 2/9	1,847	60
HMM-165 AT SUBIC		
ALFA: BLT 1/9	1,868	85
HMM-164 AT OKINAWA		

MOVEMENTS

Dat 12th Mar and "D" Co, 3d Recon Bn. At Fuji for training.

JAPAN

	USMC	USN
OSD PROGRAM IX CEILING EFFECTIVE 15APR70.	4,700	73
OSD PROGRAM VIII CIELING	3,600	45
ACTUALS CHARGED AGAINST PROGRAM VIII AS OF 26FEB70.	3,764	34

1ST MAW (REAR)

MAG-15 (2,564) (34)
VMFA-232 (F-4J)
VMFA-334 (F-4J)
VMA(AW)-533 (A-6A)
VMA-211 (A-4E)
(Less command)

Non FMF (1,200)

*Does NOT include 276 hospitalized SVN-Originated Patients.

* Includes only U. S. Navy Personnel organic to FMF Units.
Includes SU#1 and 1st ANGLICO at various locations throughout SVN.
• Latest Change

Unclassified

UNCLASSIFIED

MARINE CORPS
FEB 23 1970
REFERENCE BRANCH

Unclassified

UNCLASSIFIED

SUMMARY OF MAJOR US AND FVMAF OPERATIONS

OPERATION (DATE COMMENCED)	UNITS INVOLVED	LOCATION	CASUALTIES AS OF: 272400H FEB70		
			FRIENDLY		ENEMY
			RIA	WIA	KIA
GREENE RIVER (19JAN70)	1ST BDE, 5TH INF DIV (MECH): 4 USA BNS	EASTERN QUANG TRI PROVINCE	5	135	78
RANDOLPH GLEN (7DEC69)	101ST ABN DIV (AM): 9 USA BNS	QUANG TRI & THUA THIEN PROVINCES	67	322	475
VICTORY DRAGON XIX (1JAN70)	2D ROKMC BDE: 4 ROKMC BNS	HOI AN AREA	12	13	23
FREDERICK HILL (18MAR69)	196TH INF BDE: 3 USA BNS	QUANG TIN PROVINCE	390	2,431	4,603
GENEVA PARK (18JUL69)	198TH INF BDE: 2 USA BNS	QUANG TIN & QUANG NGAI PROVINCES	132	876	1,248
NANTUCKET BEACH (20JUL69)	198TH INF BDE: 1 USA BN	CENTERED 15 KM NE OF QUANG NGAI CITY	24	228	254
IRON MOUNTAIN (18MAR69)	11TH INF BDE: 5 USA BNS	QUANG NGAI PROVINCE	291	1,702	2,569

* - ADJUSTED
- FINAL CUMULATIVE CASUALTIES

UNCLASSIFIED

Unclassified

UNCLASSIFIED

U. S. MARINE CORPS AIRCRAFT LOSSES IN SEASIA

27 FEBRUARY 1970

DATE	COMBAT	OPERATIONAL	REMARKS
29AUG69	1 F-4B		AT933396. A/C commenced bomb run, was hit by enemy fire & failed to pull out of dive. 2 KIA. RVN.
1SEP69	1 CH-53A		YD345112. A/C crashed & burned. 4 KIA, 1 MIA. RVN.
19AUG69	1 F-4B		Missing 23 miles NE of Chu Lai. Suspected Loss at Sea. 2 MIA. RVN.
2SEP69		1 O-1G	QUANG TRI AF. A/C destroyed by collapsing hangar during Typhoon. RVN.
19SEP69		1 F-4B	CHU LAI Runway #32. A/C while landing at south end of runway went off the Starboard side splitting the A/C in two. 1 killed (Grd Crew) 1 injured. RVN.
19SEP69	1 AH-1G		AT901655. Hit by ground fire, crashed and burned. 1 KIA, 1WIA. RVN.
21SEP69	1 A-6A		XD939600. Hit by ground fire, crashed and burned. 2 WIA. RVN.
20SEP69	1 F-4B		BS 420890. A/C crashed. Observed receiving ground fire prior to impact. 2 KIA. RVN.
29SEP69	1 A-6A		A/C failed to return from mission. Location, casualties & circumstances unknown.
9OCT69		1 CH-46A	DANANG Bay. Dropped while being lifted by CH-54. A/C destroyed on impact.
10OCT69	1 UH-1E		YD0664. A/C on MedEvac mission, suspected hit by enemy fire, crashed and burned. 3 KIA, 1 WIA. RVN.
17OCT69		1 A-4E	Chu Lai Airfield. Nose gear blew. A/C continued through overrun into sand. Pilot ejected 1 WIA. RVN.
1NOV69		1 CH-53A	BT1576. Number 2 engine exploded, A/C became uncontrollable, crashed into sea. 1 injured, 4 killed. RVN.
12NOV69	1 AH-1G		AT9543. Took intense ground fire, A/C landed and burst into flames. 2 KIA. RVN.
13NOV69	1 CH-46D		BT206559. A/C Landed in sandy LZ, became uncontrollable and rolled on side, caught fire, setting off claymore mine. 1 WIA. RVN.
16NOV69	1 A-6A		BT010910. A/C Experienced flame out, crashed at sea. 1 WIA. RVN.
29NOV69	1 CH-46D		AT983348. DISINTEGRATED MID-AIR, 7 KIA. RVN.
2DEC69	1 UH-1E		XD2040. Hit by ground fire & crashed. A/C destroyed on ground by crew. 4 WIA.
6DEC69		1 A-4E	Chu Lai Air Base. A/C blew tire on take-off, veered right and left runway. Pilot ejected. No injuries. RVN.
7DEC69		1 CH-46D	AT858519. A/C attempting to land in zone for emergency MedEvac, hit an unknown object, crashed and burned. 4 injured. RVN.
21DEC69		1 UH-1E	YD5636. A/C Force Landed due to Engine flame-out. A/C tactical recovery by Army CH-47. At 75-100 feet A/C began to swing violently due to strap failure. A/C dropped.
27DEC69	TA-4F		XD278409. A/C received enemy fire (suspected 37mm). Crew ejected and recovered. 2 WIA(MIN).
28DEC69	F-4B		XD215249. A/C RECEIVED ENEMY FIRE WHILE FLYING SUPPORT FOR DOWNED TA-4F. CREW EJECTED AND RECOVERED. 2 WIA(MIN).
22DEC69		1 UH-1E	AT830555. Lost tail rotor while circling LZ & crashed. 4 injured. RVN.
28DEC69		1 CH-46D	AT908921. Cause unknown. 10 killed. RVN.
28DEC69		1 C-117D	BS373964. Cause unknown. Recon team recovered 4 bodies. RVN.
5JAN70	1 F-4B		XD150575. Hit by ground fire, crashed and burned. 2 KIA. RVN.
9JAN70	1 A4E		BT145491. Hit by ground fire and crashed. 1 KIA. RVN.
11JAN70		1 CH-46D	BT041787. Crashed and burned in LZ. Crew: 1 killed, 3 injured. ROKMC: 2 killed, 14 injured. ROK Civilian: 1 killed, 1 injured. RVN.
7FEB70		1 F-4B	CHU LAI AB. Crashed on takeoff. Pilot and RIO ejected safely.
12FEB70	1 CH-46D		ZC 1555. Hit by small arms fire in LZ, rolled down a hill. A/C destroyed by friendly air. RVN.
12Feb70	1 F-4B		YD 800450. Last seen rolling into an inverted position. 2 MIA. RVN.
16FEB70	1 CH-46D		ZD 132096. Crashed and burned. 5 KIA. RVN.
18FEB70		1 AH-1G	ZC 125665. Lost tail rotor and crashed into mountain. 1 MIA. RVN.
20FEB70		1 F-4B	AT946344. A/C flew through its own weapon which detonated remaining ordnance. Crew ejected and recovered. RVN.
26FEB70	1 A-4E		BT090773. Hit by ground fire, crashed at sea. 1 WIA. RVN.

* INDICATES LATE ENTRY.

** CRASH SIGHT LOCATED 28DEC68 IN HAI VAN PASS AREA. NO INDICATION OF SURVIVORS.

UNCLASSIFIED

171-8

Unclassified

~~CONFIDENTIAL~~

UNCLASSIFIED

U.S. MARINE CORPS AIRCRAFT LOSSES IN SEASIA

27 FEBRUARY 1970

DATE	COMBAT	OPERATIONAL	REMARKS

RECAPITULATION OF AIRCRAFT LOSSES

COMBAT		OPERATIONAL	
HELICOPTER	FIXED WING	HELICOPTER	FIXED WING
237	165	158	78
77 UH-34D	55 A-4C/B	74 UH-34D	29 A-4C/E
60 UH-1E	55 F-4B	49 CH-46A/D	18 F-4B/J
91 CH-46A/D	14 F-8E	28 UH-1E	8 F-8E
6 CH-53A	15 A-6A	6 CH-53	6 O-1B/C/G
1 CH-37C	4 EF-10B	1 AH-1G	4 A-6A
2 AH-1G	2 KC-130F		2 C-117D
	2 RF-4B		2 KC-130F
	1 TF-9J		1 EF-10B
	4 TA-4F		3 TA-4F
	3 O-1G		1 RF-4B
	5 OV-10A		1 RF-8A
	5 F-4J		3 OV-10A

COMBAT		OPERATIONAL	
HELICOPTER	FIXED WING	HELICOPTER	FIXED WING
237	165	158	78
77 UH-34D	55 A-4C/B	74 UH-34D	29 A-4C/E
60 UH-1E	55 F-4B	49 CH-46A/D	18 F-4B/J
91 CH-46A/D	14 F-8E	28 UH-1E	8 F-8E
6 CH-53A	15 A-6A	6 CH-53	6 O-1B/C/G
1 CH-37C	4 EF-10B	1 AH-1G	4 A-6A
2 AH-1G	2 KC-130F		2 C-117D
	2 RF-4B		2 KC-130F
	1 TF-9J		1 EF-10B
	4 TA-4F		3 TA-4F
	3 O-1G		1 RF-4B
	5 OV-10A		1 RF-8A
	5 F-4J		3 OV-10A

21-9

~~CONFIDENTIAL~~

UNCLASSIFIED
Unclassified

UNCLASSIFIED

27 FEBRUARY 1970

MARINE CORPS COMMAND CENTER

MILITARY FORCES IN RVN *

RVN ARMED FORCES (RVNAF)

ARMY (ARVN)	416,278
NAVY (VNN)	30,143
AIR FORCE (VNAF)	36,469
MARINE CORPS (VNUMC)	11,528
REGIONAL FORCES (RF)	260,455
POPULAR FORCES (PF)	214,383
TOTAL RVNAF	969,256

UNITED STATES FORCES

ARMY	334,363
NAVY	29,017
AIR FORCE	56,106
MARINE CORPS	51,878
COAST GUARD	354
TOTAL U.S.	471,718

FREE WORLD MILITARY ASSISTANCE FORCES (FWMAF)

REPUBLIC OF KOREA	48,806
AUSTRALIA	7,593
PHILIPPINES	133
THAILAND	11,555
NEW ZEALAND	552
REPUBLIC OF CHINA	28
SPAIN	11
TOTAL FWMAF	68,691

TOTAL FORCES IN RVN 1,509,665

SOURCE: RVNAF MACV MONTHLY STRENGTH REPORT. ALL OTHER:
 MACV WEEKLY STRENGTH REPORT AS OF 2400, 19FEB70.
 USMC STRENGTH: MACV WEEKLY STRENGTH REPORT AS
 ADJUSTED BY MACV RPT OF ARR/DEP AS OF 2400, 25FEB70.

UNCLASSIFIED
 UNCLASSIFIED
 UNCLASSIFIED

UNCLASSIFIED

MARINE CORPS COMMAND CENTER

USMC/ENEMY CASUALTIES IN RVN

27 FEBRUARY 1970

USMC BATTLE CASUALTIES

KIA/DOW	WIA(EVAC)	WIA(RTD)	MIA/PW
12,496	48,969	35,873	81/21

USMC CASUALTY FIGURES ARE PROVIDED DAILY BY HOMC CASUALTY SECTION (CODE DNA) AND REFLECT ALL CASUALTIES REPORTED AS OF 25 FEB 70.

USMC NON-BATTLE CASUALTIES

DEAD	INJURED	MISSING
1,515	1,823	13

FIGURES INDICATED AS INJURED ARE ONLY THOSE IN SERIOUS/CRITICAL INJURY OR DISEASE CATEGORY AND DO NOT INCLUDE THOSE OF A MINOR NATURE

USMC INFLECTED ENEMY CASUALTIES

KIA	PW	WPNS
80,913	4,210	20,831

ENEMY CASUALTIES ARE COMPILED DAILY FROM THE III MAF HISSUM AND ARE RECONCILED MONTHLY WITH THE FMFPAC SUMMARY OF USMC OPERATIONS IN RVN

TYPICAL DISPOSITION OF 100 USMC WIA *

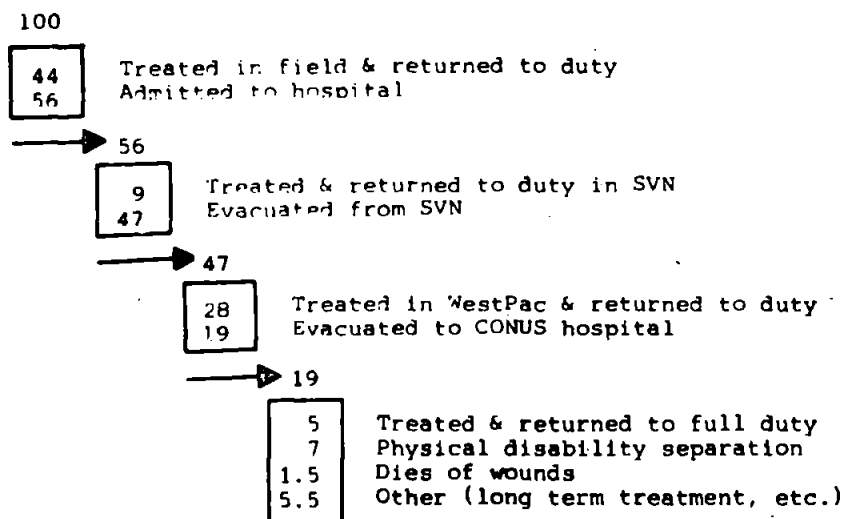

*54,081 CASUALTIES, JAN67-DEC68.

Unclassified

UNCLASSIFIED

~~SECRET~~
UNCLASSIFIED

MARINE CORPS COMMAND CENTER

FLEET MARINE FORCE ATLANTIC

READINESS SUMMARY

27 FEBRUARY 1970

UNIT	REPORT DATE	STRENGTH		COMBAT READINESS							
				CURRENT				EXPECTED			
				RATING	REASON	P	S	E	T	RATING	DATE
2D MARINE DIVISION				C2	T	1	1	1	2	C1	700401
HEADQUARTERS BN		2107	52	C2	T	1	1	1	2	C1	700331
2D MARINES		3828	99	C3	T	1	1	1	3	C2	700228
1st Bn		1216	21	C3	P	1	1	1	3	C2	700501
2nd Bn		997	19	C4	P	1	1	1	2	C3	700301
3rd Bn		1309	50	C2	P	2	1	1	1	C3	700705
6TH MARINES		3784	109	C2	T	1	1	1	2	C1	700402
1st Bn		1174	37	C1		1	1	1	1	C2	700301
2nd Bn		1183	36	C1		1	1	1	1		
3rd Bn		1054	25	C2	T	1	1	1	2	C3	700215
8TH MARINES		4256	109	C2	T	1	1	1	2	C1	700301
1st Bn		1334	35	C2	T	1	1	1	2	C1	700228
2nd Bn		1374	34	C1		1	1	1	1	C2	700630
3rd Bn		1189	36	C2	P	2	1	1	1	C3	700301
10TH MARINES		3185	50	C1		1	1	1	1	C2	700430
1st Bn		825	11	C1		1	1	1	1	C2	700430
2nd Bn		756	11	C1		1	1	1	1	C2	700430
3rd Bn		690	5	C1		1	1	1	1	C2	700430
4th Bn		641	7	C2		1	1	2	1	C1	700302
2D SERVICE BN		1269	26	C2	T	1	1	1	2	C1	700630
2D AT BN		463	7	C2	S	1	2	2	2	C1	700331
2D MT BN		306	6	C1		1	1	1	1	C2	700201
2D RECON BN		493	12	C2	T	1	1	1	2	C1	700301
2D ENGR BN		906	8	C2	T	1	1	1	2	C1	700301
2D SP BN		570	16	C2	R	1	1	2	1	C1	700331
2D MEDICAL BN		151	114	C4	N	4	1	1	4		
2D DENTAL CO			65	C1		1	1	1	1	C2	700630
FORCE TROOPS FMFLANT											
2D FSR		3110	29	C3	P	3	2	2	3	C2	700401
2D FAG		563	4	C3	R	1	2	3	2	C1	700401
2D 155 GUN BTRY		177		C3	T	2	2	2	3	C1	700401
2D BIN HOW BTRY		226		C3	R	1	1	3	2	C1	700401
2D TANK BN		794	8	C2	R	1	2	2	1	C1	700601
2D AMTRAC BN		1095	11	C3	R	1	2	3	1	C2	700331
2D FORCE RECON CO		135	2	C3	T	2	1	1	3	C2	700401
2D RADIO BN		419	2	C2	S	2	2	2	2	C1	700731
2D ANGLICO		291	11	C4	P	4	3	3	2	C3	700331
2D BRIDGE CO		158	1	C2	P	2	1	1	1	C1	700601
2D TOPO CO		90	1	C4	P	4	1	1	2	C3	700430
2D HOSPITAL CO		32	17	C4	P	4	1	1	4	C3	700228
4TH DENTAL CO		5	33	C4	P	4	1	1	1	C3	700430
8TH COMM BN		740	7	C3	S	2	3	2	2	C2	700301
8TH MT BN		473	3	C1		1	1	1	1		
8TH ENGR BN		1216	11	C2	R	1	2	2	2	C1	700331
2D MARINE AIRCRAFT WING				C3	R	3	2	3	3	C2	700531
3D LAAM BN		631	7	C3	R	3	3	3	3	C2	700303
MWSG-27				C3	P	3	1	3	3	C2	700519
VMGR-252		285	2	C3	X	4	1	3	2	C3	700601
MAG-14				C3	X	4	1	4	4	C3	700410
VMA(AW)-224		222	2	C3	X	4	1	3	4	C3	700319
VMA(AW)-121		201	1	C4	P	4	1	4	4	C3	700515
VMA(AW)-332		216	2	C3	X	3	1	4	4	C2	700416
VMCJ-2		370	2	C3	X	3	1	4	2	C2	700430
VMA-322		216	2	C3	X	3	1	3	4	C2	700416
VMFA-513		216	2	C4	P	4	1	3	4	C3	700330
MAG-26				C4	R	3	2	4	2	C3	700401
VMO-1		277		C3	P	3	2	3	2	C2	700226
HMM-362		109		C4	P	4	1	3	4	C3	700430
HMM-162		203	1	C3	R	2	2	3	1	C2	700315
HMM-261		234	3	C4	P	4	1	2	2	C3	700603
HMM-264		204		C4	P	4	1	3	1	C3	700401
HMM-365		195	1	C4	R	2	1	4	2	C3	700331
HMM-461		164	1	C4	P	4	1	4	4	C3	700510
MAG-31				C3	T	3	2	3	3	C2	700531
VMF-333		215	1	C3	T	3	1	3	3	C2	700531
VMA-331		163	1	C3	T	2	1	3	3	C2	700601
VMF(AW)-451		215	1	C3	T	3	1	3	3	C2	700601
MAG-32				C3	P	3	2	3	3	C2	700630
VMFA-251		233	1	C3	P	3	2	3	3	C2	700602
VMFA-312		236	1	C4	T	3	2	3	3	C3	700731
VMFA-324		165	1	C4	P	4	2	3	3	C2	700501

READINESS CATEGORIES

- C-1 Fully Combat Ready
- C-2 Substantially Combat Ready
- C-3 Marginally Combat Ready
- C-4 Not Combat Ready

READINESS ABBREVIATIONS

- P Personnel Readiness
- S Supplies/Equipment on Hand
- E Equipment Readiness
- T Training Readiness

NOTE: READINESS CATEGORY INFORMATION EXTRACTED FROM STATUS OF MARINE UNIT REPORT DATED 23FEB70.
STRENGTH CATEGORY INFORMATION EXTRACTED FROM MCCC REPORT DATED 4FEB70.

Unclassified
UNCLASSIFIED

~~CONFIDENTIAL~~
UNCLASSIFIED

MARINE CORPS COMMAND CENTER

SELECTED PERSONNEL AND AIRCRAFT DATA

PERSONNEL

28 FEBRUARY 1970

	STRENGTH	PERCENT USMC	PERCENT FMF	PERCENT FMFPAC
USMC TOTAL	301,675 *	100.00		
FLEET MARINE FORCES	153,295	50.81	100.00	
FMF ATLANTIC	45,696 \$	15.14	29.81	
FMF PACIFIC	107,599 #	35.66	70.19	
VIETNAM	51,855 †	17.23	34.21	48.74

SOURCE: * MONTHLY USMC PERSONNEL ALLOCATION REPORT OF 31DEC69.
\$ MCCC UNIT REPORT OF 12FEB70.
MCCC UNIT REPORT OF 4FEB70.
† MACV WEEKLY STRENGTH REPORT AS OF 2400, 19FEB70 AS ADJUSTED BY THE MACV DAILY RPT OF ARR/DEP AS OF 2400, 26FEB70.

AIRCRAFT

25 FEBRUARY 1970

	FIXW	HELO	TOTAL	PERCENT USMC	PERCENT FMF	PERCENT FMFPAC
USMC TOTALS	1013	569	1582	100.00		
FLEET MARINE FORCES	756	563	1319	83.37	100.00	
FMF ATLANTIC	293	162	455	28.76	34.49	
FMF PACIFIC	463	401	864	54.61	65.50	
VIETNAM	156	168	324	20.48	24.56	37.50

SOURCE: MARINE CORPS COMMAND CENTER UNIT REPORT OF 18FEB70.

UNCLASSIFIED

UNCLASSIFIED

FLEET MARINE FORCE DEPLOYMENTS

28 FEBRUARY 1970



1ST MAR BRIG
HAWAII

I MEF
OKINAWA
& JAPAN

10TH MARINES
DET, 2D FAG
DET 1, HMM-264
AT VIEQUES FOR FIREX. PLT, 2D ANGLICO
ETD 25MAR70 FOR
CAMLEJ.

GTMO AUGMENT

2D BN, 8TH MAR
BTRY B/1/10
PLT, 2D TK BN
DET, FSR

LANFORCARIB 1-70

BLT 3/2 & HMM-261
AT GTMO

LANFOR6THFLT 3-69

AT ATHENS

III MAF

RVN

SLF, 7TH FLEET

SLF ALFA

AT OKINAWA

SLF BRAVO

AT SUBIC

DET, 12THMAR "D" CO,
3D RECON BN AT FUJI
FOR TRNG.

DISTRIBUTION OF MAJOR FMF UNITS

	INF BNS	VMFA	VMA	VMA(AW)	VMCJ	HMM	BMH	BML	VMO	VMGR
WESTPAC	18	5	2	3	1	6	2	2	2	1
RVN	(12)	(3)	(1)	(2)	(1)	(4)	(1)	(2)	(2)	
OKINAWA/JAPAN	(4)	(2)	(1)	(1)			(1)		(1)	(1)
ASSIGNED TO SLF'S	(2)					(2)				
MIDPAC	1	2								
HAWAII AFLOAT	(1)	(2)								
EASTPAC	2	**3	2		1	2	2	1		1
WEST COAST AFLOAT	(2)	(3)	(2)		(1)	(2)	(2)	(1)		(1)
ATLANTIC	8	5	2	3	1	4	2		1	1
EAST COAST CARIBBEAN	(6) (2)	(5)	(2)	(3)	(1)	(3) (1)	(2)		(1)	(1)
EUROPE	1									
MEDITERRANEAN	(1)									
GRAND TOTAL	30	15	6	6	3	12	6	3	3	3

** VMFA-323 IN CADRE STATUS.

UNCLASSIFIED

Unclassified

UNCLASSIFIED

DISTRIBUTION OF PERSONNEL

FLEET MARINE FORCE, PACIFIC

28 FEBRUARY 1970

UNIT	NOTE	ASSIGNED STRENGTH		STRENGTH RPT DATE	DANANG		CHU LAI		PHU BAI		No I CTZ		OKINAWA		JAPAN		HAWAII		EASTPAC		OTHER		
		USMC	USN		USMC	USN	USMC	USN	USMC	USN	USMC	USN	USMC	USN	USMC	USN	USMC	USN	USMC	USN	USMC	USN	USMC
1ST BRIG																							
MAG-24																							
H&MS-24		455															455						
MABS-24		349	27														349	27					
MACS-2		200															200						
MATCU-70		40															40						
VMFA-212		278															278						
VMFA-235		266															266						
3D MAW																							
MWHG-3																							
H&MS-3		671	99																	671	99		
MWFS-3		174																		174			
MWCS-3		265																		265			
MCCRTG-10																							
H&MS-10		279	2																	279	2		
VMAT-102		208																		208			
VMT-103		190																		190			
MHTG-30																							
H&MS-30		358	1																	358	1		
HMMT-301		164	1																	164	1		
HMMT-302		191	1																	191	1		
MAG-33																							
H&MS-33		926	1																	926	1		
MABS-33		533	3																	533	3		
MATCU-65		61																		61			
VMCJ-3		371	1																	371	1		
VMA-223	7	166	1																	166	1		
VMA-214		218																		218			
VMFA-531		380	1																	380	1		
VMFA-542		269	1																	269	1		
VMFA-323 (CAIRE)		12																		12			
VMFAT-101		511																		511			
MWSG-37																							
H&MS-37		663	3																	663	3		
WERS-37		308	1																	308	1		
VMGR-352		371	1																	371	1		
MACG-38																							
H&MS-38		312	2																	312	2		
MACS-1		301																		301			
MACS-3		269	4																	269	4		
MACS-7		284	1																	284	1		
1ST LAAM BN		144																		144			
2ND LAAM BN		764	18																	764	18		
MAG-56																							
H&MS-56		483																		483			
MABS-56		467	2																	467	2		
MATCU-74		81																		81			
HMM-163		255	1																	255	1		
HML-267		383	5																	383	5		
HMM-265		215	1																	215	1		
HMH-363		274																		274			
MATCU-75		48																		48			
HMH-361	7	185	1																	185	1		
USMC		30,998			8,068	1,956	0	0	2,434	3,809	4,952	11,754	186										
USN		458			135	38	0	0	48	27	55	152	3										
AVIATION TOTAL		31,456			8,203	2,021	0	0	2,482	3,836	5,007	11,906	189										

RECAPITULATION OF FMFAC PERSONNEL DISTRIBUTION

		ASSIGNED STRENGTH	DANANG	CHU LAI	PHU BAI	No I CTZ	OKINAWA	JAPAN	HAWAII	EASTPAC	OTHER
GROUND TOTAL	USMC	76,940	38,481	1,569	685	789	16,500	0	3,553	13,511	1,852
	USN	3,441	1,824	21	7	13	889	0	109	524	54
AVIATION TOTAL	USMC	30,998	8,068	1,956	0	0	2,434	3,809	4,952	11,754	186
	USN	458	135	38	0	0	48	27	55	152	3
GRAND TOTAL	USMC	107,938	46,549	3,524	685	789	18,934	3,809	4,952	25,265	2,038
	USN	3,899	1,959	59	7	13	937	27	55	676	57

- NOTES:
- FIGURES IN "OTHER" ASSIGNED TO SLP'S.
 - FIGURES IN "OTHER" ASSIGNED TO VARIOUS LOCATIONS IN RVN.
 - PERSONNEL IN "OTHER" ARE ASSIGNED TO IT, ITP, SSC, CIT, RED EYE AND NUCLEAR ORINANCE PLATOONS.
 - STRENGTH INCLUDED IN 1ST AND 3D TANK BATTALIONS.
 - THE 559 PERSONNEL LISTED IN "OTHER" ARE HOSPITALIZED AT LOCATIONS OTHER THAN OKINAWA, BUT ARE CARRIED ON THE ROLLS OF CASUAL COMPANY, MCB, CAMP BUTLER.
 - AT SUBIC
 - ENROUTE EASTPAC.
 - PERSONNEL ARE NON-FMF CARRIED FOR OSD PROGRAM STRENGTH TOTALS ONLY.
 - UNLESS OTHERWISE NOTED, STRENGTHS AND LOCATION ARE THOSE REPORTED BY UNIT PERSONNEL STATUS REPORTS AND DO NOT REFLECT DAY-TO-DAY ADJUSTMENTS BETWEEN PERIODS.
 - UNLESS OTHERWISE NOTED STRENGTH REPORT DATE IS 12FEB70.

Unclassified

UNCLASSIFIED

28 FEBRUARY 1970

UNCLASSIFIED

SELECTED UNIT COMMANDERS AND STAFF OFFICERS

HEADQUARTERS III MARINE AMPHIBIOUS FORCE

COMMANDING GENERAL	LTGEN H. NICKERSON, JR.
DEPUTY COMMANDER	MGEN G. S. BOWMAN, JR.
CHIEF OF STAFF	BGEN L. J. DULACKI
DEPUTY CHIEF OF STAFF	COL S. A. DRESSIN
ACOS, G-1	COL R. L. PARNELL, JR.
ACOS, G-2	COL E. W. DZIALO
ACOS, G-3	BGEN T. H. MILLER, JR.
ACOS, G-4	COL W. F. SIMLIK
ACOS, G-5	COL C. J. PEABODY
ACOS, G-6	LTCOL R. S. BARRY
ACOS, COMPT	LTCOL J. M. VOSMIK
DEP C/S SPECIAL PROJECTS	COL A. T. WOOD

CG XXIV CTZ	LTGEN M. ZAIS USA
DEP C/S XXIV CTZ	COL M. M. COOK USMC

ACOS, CAP	COL T. E. REITZGER
COMMANDING OFFICER, 1ST CAG	LTCOL D. F. SEILER
COMMANDING OFFICER, 2ND CAG	LTCOL D. R. CHRISTENSEN
COMMANDING OFFICER, 3RD CAG	LTCOL C. M. DANIELS
COMMANDING OFFICER, 4TH CAG	LTCOL J. J. KEENAN
1ST RADIO BATTALION	LTCOL D. M. HOPKINS

1ST MARINE DIVISION

COMMANDING GENERAL	MGEN E. B. WHEELER
ADC	BGEN W. F. DOEHLER
CHIEF OF STAFF	COL C. E. WALKER
ACOS, G-1	COL R. E. BARDE
ACOS, G-2	
ACOS, G-3	COL F. H. WALDROP
ACOS, G-4	COL N. A. CANZONA
ACOS, G-5	COL L. S. HULLIER
ACOS, COMPT	LTCOL N. M. LASLAVIC, JR.
CEO	COL C. G. DAHL

<u>1ST MARINES</u>	
COMMANDING OFFICER	COL E. A. WILCOX
1ST BATTALION	LTCOL G. S. DELCUZE
2ND BATTALION	LTCOL W. V. H. WHITE
3RD BATTALION	LTCOL F. M. BOYD

<u>5TH MARINES</u>	
COMMANDING OFFICER	COL R. F. ESTEY
1ST BATTALION	LTCOL J. K. GRIFFIS, JR.
2ND BATTALION	LTCOL F. LEDER
3RD BATTALION	LTCOL J. S. GESTSON

<u>7TH MARINES</u>	
COMMANDING OFFICER	COL G. S. CODISPOTI
1ST MARINES	LTCOL C. G. COOPER
2ND MARINES	LTCOL A. E. FOLSOM
3RD MARINES	LTCOL R. G. KUMMEROW

<u>26TH MARINES</u>	
COMMANDING OFFICER	COL J. E. HARRELL
1ST BATTALION	LTCOL J. C. GOODIN
2ND BATTALION	LTCOL P. L. HUMPHREY
3RD BATTALION	LTCOL J. J. UNTERKOPFLER

<u>11TH MARINES</u>	
COMMANDING OFFICER	COL D. D. EZELL
1ST BATTALION	LTCOL J. D. SHOUP
2ND BATTALION	LTCOL V. WEAVER
3RD BATTALION	LTCOL K. N. MUELLER
4TH BATTALION	LTCOL J. F. BURKE, JR.

1ST BN, 13TH MAR	LTCOL D. H. STRAIN
------------------	--------------------

HQS BATTALION	COL W. C. PATTON
---------------	------------------

1ST ENGR BATTALION	LTCOL N. F. GLOWICKI
1ST RECON BATTALION	LTCOL W. C. DRUMWRIGHT
1ST MT BATTALION	LTCOL M. S. SHIMANOFF
1ST SP BATTALION	COL R. F. ARMSTRONG
1ST MED BATTALION	CAPT(MC) J. W. LEA
1ST TK BATTALION	MAJOR J. I. LOUDER
3RD AMTRAC BATTALION	LTCOL D. G. MEHARGUE
7TH ENGR BATTALION	LTCOL W. G. BATES
9TH ENGR BATTALION	LTCOL J. P. KRAYNAK
11TH MT BATTALION	LTCOL W. R. KEPHART

FORCE LOGISTICS COMMAND

COMMANDING GENERAL	BGEN M. J. PADALINO
CHIEF OF STAFF	COL J. L. TOBIN
ACOS, G-1	LTCOL J. E. REDELFS
ACOS, G-2	LTCOL R. L. SOLZE
ACOS, G-3	LTCOL W. W. STORM, III
ACOS, G-4	LTCOL M. H. IVINS
ACOS, G-5	MAJOR R. E. JOHNSON
ACOS, COMPT	LTCOL F. R. WARREN
CEO	MAJOR R. D. HAGAN

<u>1ST FORCE SERVICE REGT</u>	
M&S BATTALION	LTCOL L. R. WEBB
SUPPLY BATTALION	COL R. W. CALVERT
MAINT BATTALION	LTCOL E. C. MORRIS

FLSG-B/1ST SERV BN	COL D. E. MORIN
5TH COMM BATTALION (REIN)	LTCOL D. E. SHATZER

1ST MP BATTALION	LTCOL S. D. THOMADIS
3RD MP BATTALION	LTCOL C. FIMIAN

UNCLASSIFIED

Unclassified

UNCLASSIFIED

MARINE CORPS COMMAND CENTER

SELECTED UNIT COMMANDERS AND STAFF OFFICERS

28 FEBRUARY 1970

1ST MARINE AIRCRAFT WING

COMMANDING GENERAL
AWC
CHIEF OF STAFF
ACOS, G-1
ACOS, G-2
ACOS, G-3
ACOS, G-4
ACOS, COMPT
CEO

MGEN W. G. THRASH
BGEN R. H. SPANER
COL R. W. TELLER
COL G. S. STEWART
COL J. R. WEAVER
COL R. L. LAMAR
COL W. C. MCGRAW
COL E. J. ARTNAK
LTCOL T. KALUS

MWHG-1
COMMANDING OFFICER
H&MS-1
MWFS-1
MWCS-1

COL L. J. STIEN
MAJ W. S. HUMBERT
MAJOR N. F. SCHNIPPEL, JR.
MAJOR A. B. RAY

MMSG-17
COMMANDING OFFICER
H&MS-17
WERS-17

COL H. L. JENSEN
LTCOL D. SERRIN
LTCOL G. J. ERTLMEIR

MACG-18
COMMANDING OFFICER
H&MS-18
MACS-4

COL S. G. DUNWIDDIE, JR.
LTCOL H. E. HOPPMAYER, JR.
LTCOL R. W. MOLYNEUX, JR.

MASS-3
LTCOL J. H. DUBOIS

MAG-11
COMMANDING OFFICER
H&MS-11
MABS-11
VMCJ-1
VMA(AW)-225

COL N. E. HEFFERNAN
LTCOL R. F. HEBERT
LTCOL P. A. MANNING
LTCOL B. W. FARLEY
LTCOL J. J. METZKO

VMA(AW)-242
VMO-2

LTCOL S. P. LEWIS
LTCOL J. M. MORIARITY

MAG-13
COMMANDING OFFICER
H&MS-13
MABS-13
VMFA-115
VMFA-314
VMA-311
VMFA-122

LTCOL T. E. MURPHREE
MAJOR F. J. HORACK
MAJOR R. D. REVIE
LTCOL D. P. BOWEN
LTCOL T. J. KELLY
MAJOR A. R. HICKLE
LTCOL R. E. HOWARD, JR.

MAG-16
COMMANDING OFFICER
H&MS-16
MABS-16

COL J. P. BRUCE
MAJOR M. T. HORNSBY
LTCOL C. R. DUNBAUGH

HMH-463
HML-167
HMM-364
HMM-263

LTCOL C. A. BLOCK
LTCOL J. E. WEBER
LTCOL P. C. SCAGLIONE
LTCOL W. R. LEDBETTER, JR.

HMM-161
HMM-262
HML-367

MAJOR B. H. MANN
LTCOL R. A. BANCROFT
LTCOL W. G. CRETNEY

3D MARINE AIRCRAFT WING

COMMANDING GENERAL
AWC
CHIEF OF STAFF
ACOS, G-1
ACOS, G-2
ACOS, G-3
ACOS, G-4

MGEN R. G. OWENS, JR.
BGEN J. A. FEELEY, JR.
COL H. N. MEHAFFEY
LTCOL L. A. GULLING
COL R. J. GRAHAM
COL D. WILKER

MWHG-3
COMMANDING OFFICER
H&MS-3
MWFS-3
MWCS-3

COL G. L. LILLICH
LTCOL J. B. LABELLE
MAJOR J. S. LOOP
MAJOR D. B. NEWTON

MHTG-30
COMMANDING OFFICER
H&MS-30
HMHT-301
HMMT-302

COL A. F. GARROTTO
LTCOL R. W. CREIGHTON
LTCOL L. W. JARMAN
LTCOL K. D. VANEK

MAG-33
COMMANDING OFFICER
H&MS-33
MABS-33
VMCJ-3
VMA-214
VMFA-323 (CAIRE)
VMFAT-101
VMFA-531
VMFA-542
VMA-223

COL F. N. PIPPIN
LTCOL R. H. HUTCHINSON
MAJOR J. E. KEHRLE
LTCOL R. E. PERCIVAL
LTCOL W. R. SMITH
MAJ K. A. ZIMMERMAN II
LTCOL R. R. NORTON
LTCOL J. L. THATCHER
LTCOL K. A. SMITH
LTCOL J. W. IAZZO

MWCS-37
COMMANDING OFFICER
H&MS-37
WERS-37
VMGR-352

COL F. E. WILSON
LTCOL D. L. RICE
LTCOL R. W. DUPHINEY
LTCOL H. D. STOTT

MACG-38
COMMANDING OFFICER
H&MS-38
SUM1, H&MS-38
MACS-1
MACS-3
MACS-7
1STLAAM BN
2NDLAAM BN

LTCOL T. I. GUNNING
MAJOR F. L. HARDING
MAJOR D. V. STOWELL
MAJ C. F. KELLENBARGER
LTCOL T. M. KAUFFMAN
LTCOL D. E. ROBERTS
MAJOR E. L. HOUSE, JR.
MAJOR H. J. BALDWIN, JR.

MAG-56
COMMANDING OFFICER
H&MS-56
MABS-56
HMH-363
HML-267
HMH-361
HMM-163
HMM-265

COL M. D. PORTER
LTCOL G. H. BUCKNER II
LTCOL F. L. YOHE
LTCOL R. P. BRAY
LTCOL J. M. BLANC
LTCOL R. A. GOVONI
LTCOL F. A. MATHEWS
LTCOL R. C. COURTNEY

MCCRTG-10
COMMANDING OFFICER
H&MS-10
VMAT-102
VMT-103

COL G. FINK
MAJ I. L. DRIEFER
LTCOL B. A. SCHAFFER
LTCOL M. T. GARRISON

UNCLASSIFIED

Unclassified

FOR [REDACTED]

MARINE CORPS COMMAND CENTER

SELECTED UNIT COMMANDERS AND STAFF OFFICERS

28 FEBRUARY 1970

UNCLASSIFIED

HEADQUARTERS I MEF	
COMMANDING GENERAL	MGEN W. K. JONES
CHIEF OF STAFF	COL C. J. BAILEY, JR.
ACOS, G-1	MAJOR R. E. DOLAN
ACOS, G-2	LTCOL J. A. MACINNIS
ACOS, G-3	COL H. S. WILSON
ACOS, G-4	COL J. H. KEITH, JR.
CEO	LTCOL R. G. DEEM

3D MARINE DIVISION		1ST MAW (REAR)	
COMMANDING GENERAL AIC/CG 11TH MEB	MGEN W. K. JONES BGEN L. E. FRIBOURG	COMMANDING GENERAL	BGEN W. G. JOHNSON
CHIEF OF STAFF	COL R. P. WRAY	CHIEF OF STAFF	COL E. E. PEARCY
ACOS, G-1	LTCOL W. S. DANIELS	ACOS, G-1	MAJOR W. J. KLIMEK
ACOS, G-2	COL C. G. MOODY, JR.	ACOS, G-2	MAJOR F. G. NEWCOMB
ACOS, G-3	COL E. R. REID	ACOS, G-3	MAJOR J. W. PERSONS
ACOS, G-4	COL R. C. DAMM	ACOS, G-4	COL R. J. BARBOUR
ACOS, G-5	LTCOL M. J. GOTT	ACOS, G-5	MAJOR M. S. VALENTINI
ACOS, COMPT	LTCOL E. F. GRAYSON	CEO	MAJOR H. R. STENNIS
CEO	LTCOL A. D. BEACH	H&HS-1 (REAR)	
<u>4TH MARINES</u>		<u>MAG-15</u>	
COMMANDING OFFICER	COL W. E. BARRINEAU	COMMANDING OFFICER	COL E. E. PEARCY
1ST BATTALION	LTCOL W. A. HOLMBERG	H&MS-15	MAJOR L. K. WARN
2ND BATTALION	LTCOL D. J. GARRETT	MABS-15	LTCOL R. MACARTHUR
3RD BATTALION	LTCOL J. P. KEMOE	VMFA-334	LTCOL D. W. ANDERSON
		VMFA-232	LTCOL R. J. SORENSEN
		VMA(AW)-533	LTCOL D. L. HARVEY
<u>9TH MARINES</u>		<u>MAG-36</u>	
COMMANDING OFFICER	COL R. J. THOMAS	COMMANDING OFFICER	COL O. V. GALLENTINE
1ST BATTALION	LTCOL D. J. MCADAMS	H&MS-36	MAJOR J. F. GOLDEN
2ND BATTALION	LTCOL J. R. VANDENELZEN	MABS-36	MAJOR E. W. LOCKARD
3RD BATTALION	LTCOL H. M. HART		
<u>12TH MARINES (-)</u>		VMGR-152	LTCOL A. H. MANHARD, JR.
COMMANDING OFFICER	COL W. W. CROMPTON	HMM-164	MAJOR E. L. KUYKENDALL
2ND BATTALION	LTCOL F. W. STCLAIR	HMM-165	LTCOL D. H. MITCHELL
3RD BATTALION	LTCOL D. R. MCILLAN, JR.	HMH-462	LTCOL T. F. LOTTSFELDT
4TH BATTALION	LTCOL G. A. HIEBER	VMO-6	MAJOR J. A. BRANDON
<u>SLF BRAVO</u>		<u>MACG-18 (REAR)</u>	
COMMANDER	COL G. G. CHAMBERS, JR.	COMMANDING OFFICER	LTCOL P. E. SHEA
BLT 2/9	LTCOL J. R. VANDENELZEN	H&HS-18 (REAR)	MAJOR R. L. GOODLAKE
HMM-165	LTCOL D. H. MITCHELL	MACS-8	LTCOL G. G. LONG
		MASS-2	MAJOR J. D. ODEN
<u>SLF ALFA</u>		<u>MAG-12</u>	
COMMANDER	COL C. W. BOYD, JR.	COMMANDING OFFICER	COL P. B. HENLEY
BLT 1/9	LTCOL D. J. MCADAMS	H&MS-12	LTCOL J. J. WENT
HMM-164	MAJOR E. L. KUYKENDALL	MABS-12	LTCOL H. F. WITTER
		VMA-211	LTCOL L. GASPERINE, JR.
HQS BATTALION	LTCOL C. F. KING, JR.		
3RD AT BATTALION			
3RD ENGR BATTALION (-)	LTCOL J. W. MEDIS		
3RD RECON BATTALION (-)	LTCOL R. I. KRAMER		
3RD MT BATTALION (-)	MAJOR L. D. DERRYBERRY		
3RD SP BATTALION (-)	LTCOL K. L. CHRISTENSEN		
3RD MED BATTALION	CAPT(MC) J. V. BROWN		
3RD TANK BATTALION (-)	LTCOL R. W. MARTIN		
7TH COMM BATTALION (-)	MAJOR A. E. HARWOOD		
9TH MT BATTALION (-)	MAJOR H. H. RUHL, JR.		
3RD SERV BATTALION (-)	COL E. M. YOUNG		
11TH ENGR BATTALION	LTCOL B. A. KASSMAN		
1ST AMTRAC BATTALION	MAJOR A. W. LAMB		

UNCLASSIFIED

Unclassified

CONFIDENTIAL

UNCLASSIFIED

DISTRIBUTION OF MAJOR FMFPAC TACTICAL UNITS

28 FEBRUARY 1970

UNIT	CHU LAI	DANANG	NoICTZ/DMZ	OKINAWA	JAPAN	HAWAII	EASTPAC	OTHER	NOTE
1ST MARINES		1/1, 2/1, 3/1							
3D MARINES						1/3	2/3, 3/3		
4TH MARINES				1/4, 2/4, 3/4					
5TH MARINES		1/5, 2/5, 3/5							
7TH MARINES		1/7, 2/7, 3/7							
9TH MARINES				3/9				1/9, 2/9	1
26TH MARINES		1/26, 2/26, 3/26							
MAG-11		VMCJ-1 VMA(AW)-225 VMA(AW)-242 VMO-2							
MAG-12					VMA-211				
MAG-13	VMA-311 VMFA-115 VMFA-122 VMFA-314								
MAG-16		HML-167 HML-367 HMM-161 HMM-262 HMM-263 HMM-364 HMH-461							
MAG-36				VMO-6 HMH-462				HMM-164 HMM-165	1 1
MAG-15					VMFA-232 VMFA-334 VMA(AW)-533				
MAG-24						VMFA-212 VMFA-235			
MAG-33							VMA-214 VMA-223 VMCJ-3 VMFA-323 * VMFA-531 VMFA-233		
MAG-56							HML-267 HMM-163 HMM-265 HMH-361 HMH-363		

DISTRIBUTION OF MAJOR GROUND EQUIPMENT

EQUIPMENT	T/E AUTH	CHU LAI	DANANG	NoICTZ/DMZ	OKINAWA	HAWAII	EASTPAC	OTHER	NOTE
60mm MORTAR M19	254		144		60	12	24	12	1
81mm MORTAR M29	168		96		40	8	16	8	1
106mm RR M40A1C	168		96		40	8	16	8	1
107mm MORTAR M30	42		24		6	6		6	1
105mm HOW TD M101A1	136		72		30	6	12	6	1
155mm HOW SP M109	42		24		12		6		
175mm GUN(SP)	18		12	6					
81n HOW SP M110	14		12	2					
ONTOS M50A1	115		15		75		15	10	1
90mm TANK M48A3	126		73		36		17		1
120mm TANK M103A2	17						17		
FLAME TANK M67A2	27		12		9		6		
LVTH6	18		6		12				
LVTP5	280		112		113		44	11	1
LVTE1	24		8		8		8		
HAWK LAUNCHERS	36						36		

- NOTES:
1. UNITS/EQUIPMENT IN OTHER ASSIGNED TO SLF'S
 2. ENROUTE CONUS
 3. ENROUTE OKINAWA
 4. CADRE

Unclassified

UNCLASSIFIED

DISTRIBUTION OF AIRCRAFT, FMFPAC

28 FEBRUARY 1970

UNIT	DANANG	CHU LAI	PHU BAI	OKINAWA	JAPAN	HAWAII	EASTPAC	OTHER
HQ SQDN, FMFPAC						6/T-1A 1/C-54R 1/C-47J		
MAG-11 H&MS-11	8/TA-4F 1/C-117D							
VMCJ-1	7/RF-4B 11/EA-6A							
VMA(AW)-242	12/A-6A							
VMA(AW)-225	12/A-6A							
VMO-2	19/OV-10A							
MAG-12 H&MS-12 VMA-211					14/A-4E			
MAG-13 H&MS-13 VMA-311		1/C-117D 20/A-4E						
VMFA-115 VMFA-314 VMFA-122		15/F-4B 15/F-4B 13/F-4B						
MAG-15 H&MS-15					1/C-540 1/C-117D 3/TA-4F 1/C-54S 15/F-4J 12/F-4J 13/A-6A			
VMFA-232 VMFA-334 VMA(AW)-533								
MAG-16 H&MS-16	2/C-117D 1/CH-46A							
HML-167 HML-367 HMM-263 HMM-161 HMM-262 HMM-364 HMH-463	42/UH-1E 24/AH-1G 20/CH-46D 21/CH-46D 19/CH-46D 21/CH-46D 20/CH-53A/D							
MCCRTG-10 H&MS-10								
VMAT-102 VMT-103						26/A-4C 16/TA-4F		
MWSG-17 H&MS-17	3/US-2B 3/C-117D							
MHTG-30 H&MS-30							5/CH-46D	
HMHT-301 HMMT-302							10/CH-53A 19/CH-46D	
MAG-33 H&MS-33							4/F-4B 6/TA-4F	
VMA-223 VMCJ-3							20/A-4E 9/RF-4B 12/EF-10B 13/A-4C	
VMA-214 VMFA-323 (CADRE) VMFA-531 VMFAT-101 VMFA-542							15/F-4B 18/F-4B 15/F-4B	
MAG-36 H&MS-36				1/C-117D 2/UH-34D 9/CH-46A/T 12/KC-130F				
VMGR-152 HMM-165 HMM-164 HMH-462 VMO-6				14/CH-53A 10/UH-1E 18/OV-10A				18/CH-46A 17/CH-46A

NOTES: * ASSIGNED TO SLF's
** ENROUTE CONUS

UNCLASSIFIED
Unclassified

~~UNCLASSIFIED~~
UNCLASSIFIED

MARINE CORPS COMMAND CENTER

DISTRIBUTION OF AIRCRAFT, FMFPAC

28 FEBRUARY 1970

UNIT	DAWANG	CBU LAI	PBO BAI	OKINAWA	JAPAN	HAWAII	EASTPAC	OTHER
MWSG-37 H&MS-37							2/C-47J 3/C-54R/P/A 2/C-117D 1/C-47H	
VMGR-352							12/KC-130F	
MAG-56 H&MS-56							3/CH-46D 11/CH-53A 1/UH-1E	
HMH-361							19/CH-46A 14/CH-53A	
HML-267							7/OV-10A 18/UH-1E	
HMM-163							21/CH-46F	
HMH-363							20/CH-53A	
HMM-265							17/CH-46D	
MABS-56							1/CH-53A	
1ST MARINE BRIGADE MAG-24 H&MS-24						1/C-117D 4/UH-34D 3/TA-4F		
VMFA-212						15/F-4J		
VMFA-235						12/F-4J		
TOTAL FMFPAC ACFT								
FIXED WING (463)	78	64		31	60	39	191	
HELICOPTERS (401)	168			35		4	159	35

NOTE: * ASSIGNED TO SLF's
** ENROUTE CONUS

~~UNCLASSIFIED~~
UNCLASSIFIED

Unclassified

~~SECRET~~

MARINE CORPS COMMAND CENTER

MARINE CORPS PERSONNEL IN RVN

28 FEBRUARY 1970

UNCLASSIFIED

	OFF	ENL	TOTAL
* III MAF.	3,520	48,026	51,546
DANANG	(3,109)	(42,347)	(45,456)
CHU LAI	(359)	(4,254)	(4,613)
PHU BAI	(21)	(851)	(872)
DONG HA	(31)	(574)	(605)
SU #1, 1ST ANGLICO (AT VARIOUS LOCATIONS SVN)	((21))	((194))	((215))
OTHER USMC PERSONNEL	159	150	309
MACV STAFF/MACV FIELD . . .	(136)	(137)	(273)
NAVAADVGRU/NAVY UNITS . . .	(23)	(13)	(36)
USMC IN RVN CHARGED AGAINST PROGRAM VIII	3,679	48,176	51,855
U. S. NAVY, III MAF.	248	1,771	2,019

* AS REPORTED BY III MAF DAILY ADMIN SITREP # 49 AS OF 2400, 25FEB70 AND THE MACV WEEKLY STRENGTH REPORT, AS OF 2400, 19FEB70 AS ADJUSTED BY MACV DAILY RPT OF ARR/DEP AS OF 2400, 26FEB70.

Unclassified

UNCLASSIFIED

~~SECRET~~

MARINE CORPS COMMAND CENTER
WESTPAC UNIT LOCATIONS

28 FEBRUARY 1970

QUANG TRI (QUANG TRI)	USMC 605 ●
	USN 34 ●
	USA 8,584 ●
1ST BDE, 5TH INF DIV (MECH)	
1/77 ARMOR	(OPN GREENE RIVER)
1/61 INF (MECH)	(OPN GREENE RIVER)
1/11 INF	(OPN GREENE RIVER)
3/5 ARMD CAV SQDN	(OPN GREENE RIVER)

USMC RVN RECAP	USMC	USN
OSD PROGRAM IX CEILING EFFECTIVE 15APR70.....	42,610	1,811
OSD PROGRAM VIII CIELING..	55,510	2,233
PROGRAM VIII AS OF 26FEB70..	51,855 ●	2,619 ●
III MAF.....	51,546 ●	2,019 ●
SU#1 1ST ANGLICO.....	(215)	(12)
OTHER.....	309	
MACV STAFF/MACV FIELD.	(273)	
NAVALVGRU/NAVY UNITS..	(36)	

THUA THIEN HQ, XXIV CORPS (PHU BAI)	USMC 872 ●
HQ, 101st ABN DIV (AM)	USN 42 ●
	USA 22,806 ●
1ST BDE, 101ST ABN DIV (AM)	
1/327 INF (AM)	(OPN RANDOLPH GLEN)
2/327 INF (AM)	(OPN RANDOLPH GLEN)
2/502 INF (AM)	(OPN RANDOLPH GLEN)
2D BDE, 101ST ABN DIV (AM)	
1/501 INF (AM)	(OPN RANDOLPH GLEN)
2/501 INF (AM)	(OPN RANDOLPH GLEN)
1/502 INF (AM)	(OPN RANDOLPH GLEN)
3D BDE, 101ST ABN DIV (AM)	
1/506 INF (AM)	(OPN RANDOLPH GLEN)
2/506 INF (AM)	(OPN RANDOLPH GLEN)
3/187 INF (AM)	(OPN RANDOLPH GLEN)

I CORPS RECAP	
US MARINE CORPS . . .	(12 BNs) 51,546 ●
US ARMY	(25 BNs) 73,849
US NAVY	16,824 ●
US AIR FORCE	8,194
ROKMC	(4 BNs) 6,115
RVNAF	(36 BNs) 153,895
ARVN/ABN	(36 BNs) (74,634)
VNMC	
VNN	(2,100)
VNAF	(3,408)
VNRFP	(37,403)
VNPF	(36,350)
I CORPS TOTAL	77 BN 310,423 ●

QUANG NAM HOS 1ST MAR DIV (DANANG)	HOS, III MAF	USMC 45,456 ●
1ST MARINES	HQ 1st MAW	USN 1,832 ●
1/1	MAG-11	USA 1,104 ●
2/1		ROKMC 6,115
3/1		
5TH MARINES	VMA(AW)-242 (A-6A)	
1/5	VMA(AW)-225 (A-6A)	
2/5	VMCJ-1 (RF-4/EA-6/EF-10)	
3/5	VMO-2 (OV-10A)	
7TH MARINES	MAG-16	
1/7	HML-367 (AH-1G)	
2/7	HML-167 (UH-1E)	
3/7	HMH-463 (CH-53A)	
	HMM-364 (CH-46D)	
	HMM-263 (CH-46D)	
26TH MARINES	HMM-262 (CH-46D)	
1/26	HMM-161 (CH-4E)	
2/26		
3/26		
2d ROKMC BDE		
	1/2 (OPN VICTORY DRAGON XIX)	
	2/2 (OPN VICTORY DRAGON XIX)	
	3/2 (OPN VICTORY DRAGON XIX)	
	5/2 (OPN VICTORY DRAGON XIX)	
FLC 1ST FSR/FLSG-B/1ST SERV BN		

SLF 7TH FLEET	USMC	USN
BRAVO: BLT 2/9	1,847	60
HMM-165		
AT SUBIC		
ALFA: BLT 1/9	1,868	85
HMM-164		
AT OKINAWA		

MOVEMENTS
Det 12th Mar and "D" Co, 3d Recon Bn.
At Fuji for training.

QUANG TIN/QUANG NGAI HQ 23d INF DIV (AMERICAL) (CHU LAI)	USMC 4,613 ●
196TH LT INF BDE	USN 111 ●
2/1 INF (OPN FREDERICK HILL)	USA 25,085 ●
4/31 INF (OPN FREDERICK HILL)	
3/21 INF (OPN FREDERICK HILL)	
1/46 INF	
198TH LT INF BDE	
1/6 INF (OPN GENEVA PARK)	
1/52 INF (OPN GENEVA PARK)	
5/46 INF (OPN NANTUCKET BEACH)	
11TH INF BDE	MAG-13
1/20 INF (OPN IRON MOUNTAIN)	VMFA-115 (F-4B)
4/21 INF (OPN IRON MOUNTAIN)	VMFA-314 (F-4B)
3/1 INF (OPN IRON MOUNTAIN)	VMFA-122 (F-4B)
4/3 INF (OPN IRON MOUNTAIN)	VMA-311 (A-4E)
1/1 ARMD CAV SQDN (OPN IRON MOUNTAIN)	

JAPAN	USMC	USN
OSD PROGRAM IX CEILING EFFECTIVE 15APR70.	4,700	73
OSD PROGRAM VIII CIELING	3,600	45
ACTUALS CHARGED AGAINST PROGRAM VIII AS OF 26FEB70.	3,764	34

OKINAWA HQ, I MEF	USMC	USN
3D MAR DIV (-) (REIN)(TF-79)	19,200	934
11th MEB (TF-79.1)		
ACTUALS CHARGED AGAINST PROGRAM VIII AS OF 26FEB70.		
	18,387	424
4TH MARINES	MAG-36	(13,888) (349)
1/4	VMGR-152 (KC-130F)	
2/4	VMO-6 (OV-10A/UH-1E)	
3/4	HMH-462 (CH-53A)	
9TH MARINES		
3/9		
3D FSR	(3,459)	(50)
MCB CAMP BUTLER/NON FMF	(932)	(25)
Non-Deployable Casuals	(1)	
SVN-Originated Patients		

1ST MAW (REAR)	USMC	USN
MAG-15	(2,564)	(34)
VMFA-232 (F-4J)		
VMFA-334 (F-4J)		
VMA(AW)-533 (A-6A)		
MAG-12 ●		
VMA-211 (A-4E)		
Non FMF	(1,200)	

*Does NOT include 276 hospitalized SVN-Originated Patients.

Unclassified

* Includes only U. S. Navy Personnel organic to FMF Units.
Includes SU#1 and 1st ANGLICO at various locations throughout SVN.
• Latest Change

~~SECRET~~
UNCLASSIFIED

REFERENCE BRANCH
MAR 2 1970
MARINE CORPS

Unclassified

UNCLASSIFIED

MARINE CORPS COMMAND CENTER

USMC/ENEMY CASUALTIES IN RVN

28 FEBRUARY 1970

USMC BATTLE CASUALTIES

KIA/DOW	WIA(EVAC)	WIA(RTD)	MIA/PW
12,500	48,979	35,878	81/21

USMC CASUALTY FIGURES ARE PROVIDED DAILY BY HOMC CASUALTY SECTION (CODE DNA) AND REFLECT ALL CASUALTIES REPORTED AS OF 26FEB70.

USMC NON-BATTLE CASUALTIES

DEAD	INJURED	MISSING
1,515	1,823	13

FIGURES INDICATED AS INJURED ARE ONLY THOSE IN SERIOUS/CRITICAL INJURY OR DISEASE CATEGORY AND DO NOT INCLUDE THOSE OF A MINOR NATURE

USMC INFLECTED ENEMY CASUALTIES

KIA	PW	WPNS
80,943	4,212	20,834

ENEMY CASUALTIES ARE COMPILED DAILY FROM THE III MAF HISSUM AND ARE RECONCILED MONTHLY WITH THE FMFPAC SUMMARY OF USMC OPERATIONS IN RVN

TYPICAL DISPOSITION OF 100 USMC WIA *

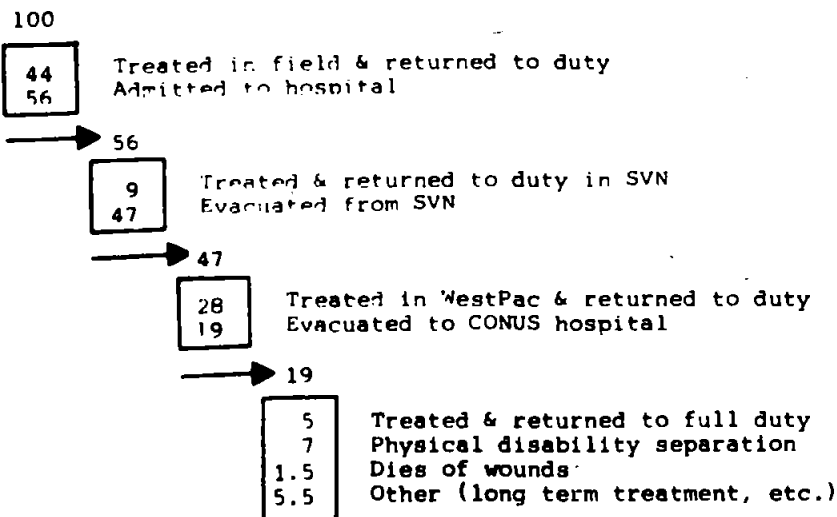

*54,081 CASUALTIES, JAN67-DEC68.

Unclassified

UNCLASSIFIED

28 FEBRUARY 1970

~~CONFIDENTIAL~~

MARINE CORPS COMMAND CENTER

MILITARY FORCES IN RVN *

RVN ARMED FORCES (RVNAF)

ARMY (ARVN)	416,278
NAVY (VNN)	30,143
AIR FORCE (VNAF)	36,469
MARINE CORPS (VNBC)	11,528
REGIONAL FORCES (RF)	260,455
POPULAR FORCES (PF)	214,383
TOTAL RVNAF	969,256

UNCLASSIFIED

UNITED STATES FORCES

ARMY	334,363
NAVY	29,017
AIR FORCE	56,106
MARINE CORPS	51,855
COAST GUARD	354
TOTAL U.S.	471,695

FREE WORLD MILITARY ASSISTANCE FORCES (FWMAF)

REPUBLIC OF KOREA	48,806
AUSTRALIA	7,593
PHILIPPINES	133
THAILAND	11,555
NEW ZEALAND	552
REPUBLIC OF CHINA	28
SPAIN	11
TOTAL FWMAF	68,691

TOTAL FORCES IN RVN 1,509,632

SOURCE: RVNAF MACV MONTHLY STRENGTH REPORT. ALL OTHER:
MACV WEEKLY STRENGTH REPORT AS OF 2400, 19FEB70.
USMC STRENGTH: MACV WEEKLY STRENGTH REPORT AS
ADJUSTED BY MACV RPT OF ARR/DEP AS OF 2400, 26FEB70.

UNCLASSIFIED

Unclassified

~~CONFIDENTIAL~~

~~CONFIDENTIAL~~

LANDING FORCE, SIXTH FLEET 3-69

21 FEBRUARY 1970

UNITS EMBARKED	STRENGTH				ARMS & EQUIPMENT	LOCATION AT ATHENS
	USMC		USN			
	OFF	ENL	OFF	ENL		
TF-61/62 CTG: LTCOL G. B. CRIST					31 7.62 MG 10 LVTP-5 6 105 HOW 5 90MM GUN TANK 5 ONTOS 8 81MM MORTARS 8 FLAME THROWERS 6 106MM RR 21 MULES 32 MITES 22 2 1/2 TON TRUCKS 8 JEEPS 3 5 TON CARGO TRUCKS 9 3/4 TON UTIL TRUCKS 4 AMBULANCES 4 CRANES AIRCRAFT NO AIRCRAFT	SHIPPING USS CAMBRIA (APA-36) USS LASALLE (LPD-3) USS RUSHMORE (LSD-14) USS WAHIAKUM (LST-1162)
BLT 2/6 (LTCOL G. B. CRIST)						
2D BN, 6TH MAR	49	1030	4	33		
DET HQCO, 6TH MAR						
BTRY "E", 2/10	9	124				
DET HQ BTRY, 2/10	2	10		2		
PLT CO "C", 2D AMTRAC BN	1	45				
PLT CO "B", 8TH MT BN		19				
PLT CO "C", 2D AT BN	1	21				
PLT CO "B", 2D ENGR BN		49				
PLT CO "A", 2D MED BN		10	1	9		
PLT CO "A", 2D TK BN	1	24				
PLT CO "A", 2D SP BN	1	49				
PLT CO "B", 2D RECON BN	1	24		1		
DET HQBN, 2D MARDIV		27				
DET 2D DENTAL CO			2	2		
DET 2D SERVICE BN	1	42				
DET 2D FSR		40				
TOTALS	66	1514	7	47		

UNCLASSIFIED

LANDING FORCE, CARIBBEAN 1-70

28 FEBRUARY 1970

UNITS EMBARKED	STRENGTH				ARMS & EQUIPMENT	LOCATION AT GTMO
	USMC		USN			
	OFF	ENL	OFF	ENL		
TASK GROUP 45.9 CTG: COL G. R. HUNTER					11 LVTP-5 5 M48 TANK 5 M50 ONTOS 6 105MM HOW TD 8 106MM RR 8 81MM MORTAR AIRCRAFT 19 CH-46D	SHIPPING USS GUADALCANAL (LPH-7) USS VERMILLION (LKA-107) USS SUFFOLK CTY (LST-1173) USS SPEIGEL GROVE (LSD-32)
HQ 36TH MEU						
BLT 3/2 (LTCOL E. F. PIERSON JR.)						
3D BN, 2D MARINES	44	1007	4	38		
BTRY "I", 3/10	10	136	1	2		
DET HQ BTRY, 3/10						
PLT CO "B", 2D AMTRAC BN	1	40				
PLT CO "C", 2D MT BN	1	33				
PLT CO "A", 2D AT BN	1	21				
PLT CO "A", 2D ENGR BN	1	49				
PLT H&S CO, 2D MED BN		10		17		
PLT CO "A", 2D TANK BN	1	24				
PLT CO "A", 2D SP BN	1	52		7		
PLT CO "C", 2D RECON BN	1	23		1		
DET HQBN, 2DMARDIV	1	25				
DET 2D DENTAL CO			1	1		
DET 2D SERV BN	1	40				
DET 2D FSR	1	37				
DET HQCO 2D MARINES		20				
HMM-261 (LTCOL V. M. HAZELBAKER)	43	170	1			
TOTALS	107	1687	7	61		

~~CONFIDENTIAL~~

UNCLASSIFIED

Unclassified

UNCLASSIFIED