

UNCLASSIFIED

HQMC SEMI-MONTHLY OPERATIONAL SUMMARY

16-99

Period Covered: 1 - 15 Sep 99

UNCLASSIFIED



Request that errors, questions, and recommendations regarding the enclosed information be reported to:

Commandant of the Marine Corps (POC)
Headquarters, U.S. Marine Corps
Washington, DC 20380-1775

(A) Commercial: (703) 614-2151
(B) DSN: 224-2151/1617
(C) STU III: 224-2151/1617
(D) FAX: 225-7366 (DSN)
(E) SIPRNET: Primary: martineza@hqmc.usmc.smil.mil
cruzee@hqmc.usmc.smil.mil
ricek@hqmc.usmc.smil.mil

UNCLASSIFIED

BRIAN J. BACH, COLONEL
HEAD, CURRENT OPERATIONS BRANCH

UNCLASSIFIED



SECURITY MISSION
3D PLT, 2D FAST CO
NAPLES, ITALY

JOINT FORGE
DET, VMU-2
DET, 4TH CAG
DET, 4TH FSSG
DET, H&S BN
AMIB
AUGMENTEES
EUCOM THEATER

PHIBRON 2 (KEARSARGE ARG)
26TH MEU(SOC)-USS Ksg - ea
IZMIT, TURKEY - ~~ea~~ 1D0 - ea

NH - HAITI
DET, MWSS-271
OPERATION UPHOLD DEMOCRACY
DET, II MEF
FORCE PROTECTION
DET, 2D INTEL BN
PORT-AU-PRINCE, HAITI

SECURITY MISSION
2D PLT, 1ST FAST CO
YOKOSUKA, JAPAN

USS CONSTELLATION
VMFA-323 - Post Jc
~~GPS IN THE~~

MIGRANT OPS
DET, 4TH CAG
GUANTANAMO BAY, CUBA

PHIBRON 1 (PELELIU ARG)
11TH MEU(SOC)
EX-IRON MAGIC, UAE

JTF-B - HONDURAS
DET, 4TH CAG
SOTO CANO AB, HONDURAS

NORTHERN WATCH
DET, VMGR-352
INCIRLIK AB, TURKEY

SECURITY MISSION
5TH PLT, 2D FAST CO
MANAMA, BAHRAIN

NH - NICARAGUA
DET, MWSS-271
DET, 4TH CAG
DET, 4TH FSSG
ESTELI, NICARAGUA

PANAMA CANAL ZONE SECURITY
CJTF - PANAMA
EAST COROZAL, PANAMA
MARFOR-PM HQ
CO E(REIN), 2/8
DET, SCCO
HOWARD AFB, PANAMA

UNITAS
II MEF MARFOR UNITAS
USS CARTER HALL
~~HUSCHO, CT~~ Valparaiso, CT

RESOLUTE RESPONSE
2D PLT(REIN), CO G, 2/7
NAIROBI, KENYA

DEPLOYED MARINE FORCES



11th MEU(SOC)/Peleliu ARG
PHIBRON 1 - CAPT HOPPER (USN)
USS PELELIU (LHA-5)
USS OGDEN (LPD-5)
USS RUSHMORE (LSD-47)
DEPLOYMENT PERIOD: 22 JUN - 22 DEC 99

Current Status: ~~Exercise Iron Magic, UAE, 20 Aug - 9 Sep.~~ *Post Jebel Ali, U.A.E. 10-16 Sep.*

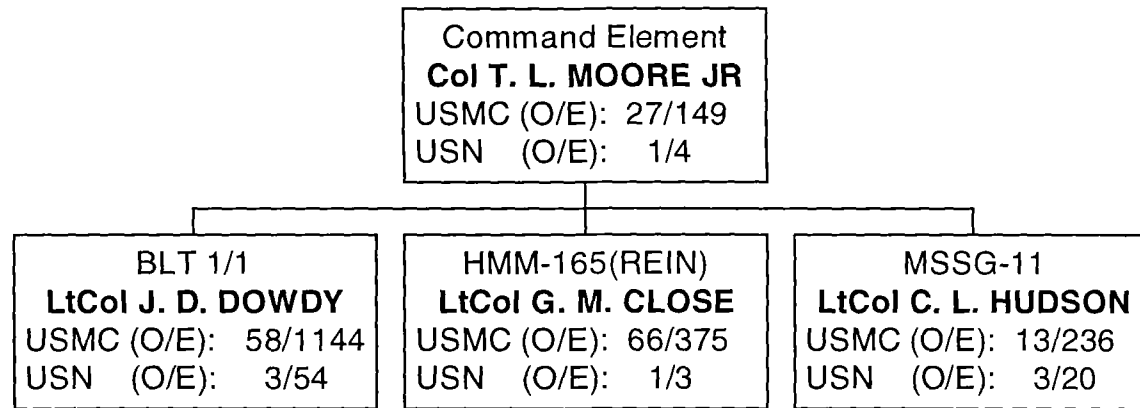

Total O/H: 2,158

ARG Conduct various Posts in: Bahrain, UAE + Qatar 18-21 Sep
Future Plans: ~~Port Visit Jebel Ali, UAE 10-16 Sep.~~

Ref: : 11TH MEU(SOC) SitRep # ~~35-99~~ *100930 Sep* of ~~201200Z Aug 99.~~ *16 Sep 99* CNO Notes of ~~30 Aug 99.~~





11th MEU(SOC)/Peleliu ARG
PHIBRON 1 - CAPT HOPPER (USN)
USS PELELIU (LHA-5)
USS OGDEN (LPD-5)
USS RUSHMORE (LSD-47)
DEPLOYMENT PERIOD: 22 JUN - 22 DEC 99

(C) ARMS AND EQUIPMENT IN POSSESSIONS: 11TH MEU(SOC) PREDEP MSG 151000Z JUN 99			
NUMBER	ITEM	NUMBER	ITEM
13	AAVP-7	13	LAV-25
1	AAVR-7	2	LAV(M)
1	AAVC-7	3	LAV(L)
8	M220 E4 TOWS	1	LAV-C2
6	M198	1	AN/TSC-93
2	M88A1/2	1	AN/MLQ-36A
1	LAV-R	4	M1A1
(C) AIRCRAFT O/H:			
NUMBER	TYPE	NUMBER	TYPE
12	CH-46E	4	AH-1W
4	CH-53E	3	UH-1N
6	AV-8B*	2	KC-130 (CONUS STANDBY)

(C) LANDING CRAFT:		
SHIP	NUMBER	TYPE
USS PELELIU	2/1	LCU/LCAC
USS OGDEN	0	N/A
USS RUSHMORE	3	LCAC

*AWAITING CLEARANCE TO CONDUCT TRANSPAC TO LINK UP WITH 11TH MEU(SOC)

UNCLASSIFIED



SECRET

26th MEU/Kearsarge ARG
PHIBRON 2 - CAPT BOLCAR (USN)
USS KEARSARGE (LHD-3)
USS PONCE (LPD-15)
USS GUNSTON HALL (LSD-44)

DEPLOYMENT PERIOD: 15 APR 99 - 15 OCT 99

Current Status: ARG/MEU conducting humanitarian assistance support to Task Force Avid Response.

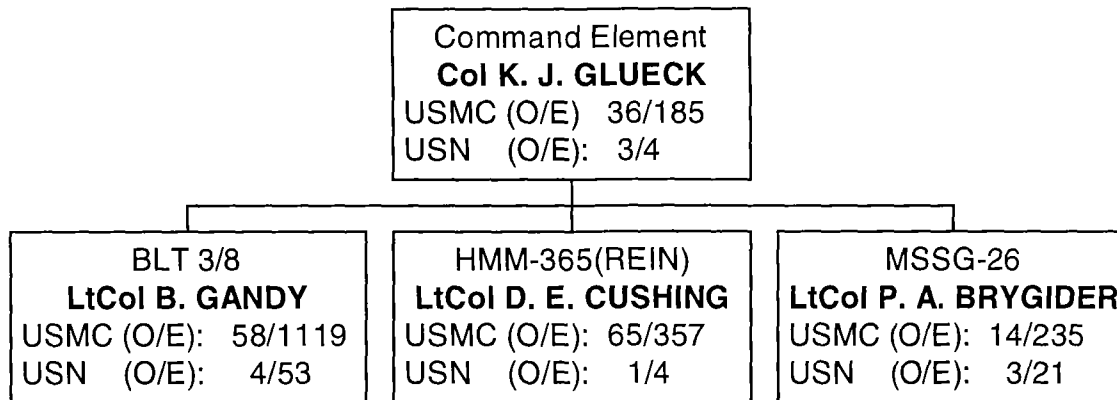

Total O/H: 2,162

Future Plans: Continue providing support to TF Avid Response UFN.

Ref: 26TH MEU(SOC) SitRep #46 of 191945Z Aug 99/CNO Notes of 30 Aug 99.

USCINCEUR msg 251935Z Aug 99 (TF Avid Response CONOPS)

SECRET

UNCLASSIFIED



26th MEU/Kearsarge ARG
PHIBRON 2 - CAPT BOLCAR (USN)

USS KEARSARGE (LHD-3)

USS PONCE (LPD-15)

USS GUNSTON HALL (LSD-44)

DEPLOYMENT PERIOD: 15 APR 99 - 15 OCT 99

(C) ARMS AND EQUIPMENT IN POSSESSIONS: 26TH MEU(SOC) PREDEP MSG 171805Z APR 99			
NUMBER	ITEM	NUMBER	ITEM
13	AAV P-7	8	LAV-25
1	AAV R-7	1	LAV(R)
1	AAV C-7	1	LAV(L)
16	M220 E4 TOWS	1	AN/TSC-93
6	M198	1	AN/MLQ-36A
1	LAV-C2		
(C) AIRCRAFT O/H:			
NUMBER	TYPE	NUMBER	TYPE
12	CH-46E	4	AH-1W
4	CH-53E	2	UH-1N
6	AV-8B *	2	KC-130 (CONUS STANDBY)

(C) LANDING CRAFT:		
SHIP	NUMBER	TYPE
USS KEARSARGE	3	LCAC
USS PONCE	1	LCU
USS GUNSTON HALL	2	LCAC

*AWAITING CLEARANCE TO CONDUCT FLIGHT OPS IOT TO LINK UP WITH 26TH MEU(SOC)

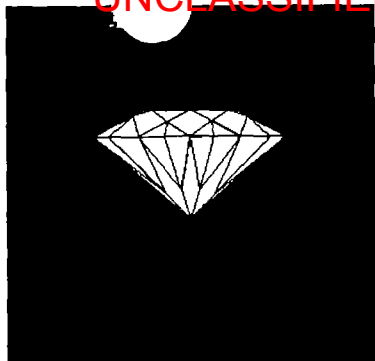

LF CARAT
USS COMSTOCK (LSD-45)
USS FREDERICK (LST-1184)
DEPLOYMENT PERIOD: 28 MAY - 1 OCT 99

Current Status: USS Frederick en route Okinawa through 6 Sep. USS Comstock anch off Nusa Dua, Bali, through 31 Aug.

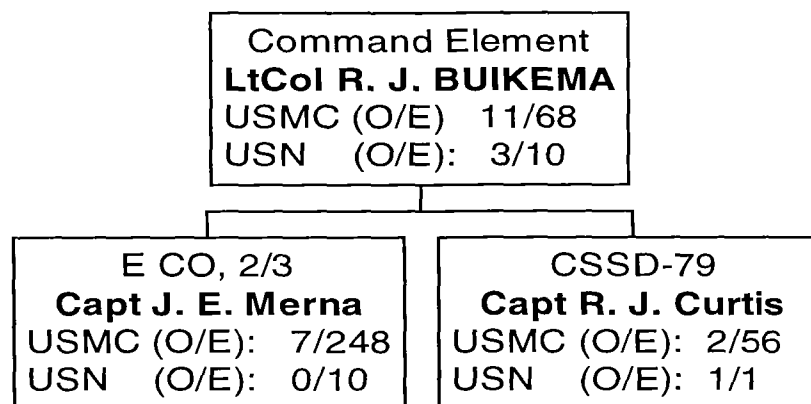

(C) ARMS AND EQUIPMENT IN POSSESSIONS: LF CARAT PREDEP MSG 241230Z MAY 99			
NUMBER	ITEM	NUMBER	ITEM
10	AAV P-7	2	LAV-25
1	AAV R-7	1	LAV-C2
1	AAV C-7	2	M220 E4 TOWS

Total O/H: 417

Future Plans: USS Frederick offload Okinawa, 7 - 9 Sep. USS Comstock en route Okinawa, 1 - 8 Sep.

Ref: LF CARAT Predeployment msg 241230Z May 99. LF CARAT SitRep 99-19 281701Z Aug 99. CNO Notes of 30 Aug 99.



UNITAS 40-99
USS CARTER HALL (LSD-50)
DEPLOYMENT PERIOD: 16 JUL - 14 DEC 99

Current Status: Conducting Phase III - Peruvian Phase through 4 Sep.

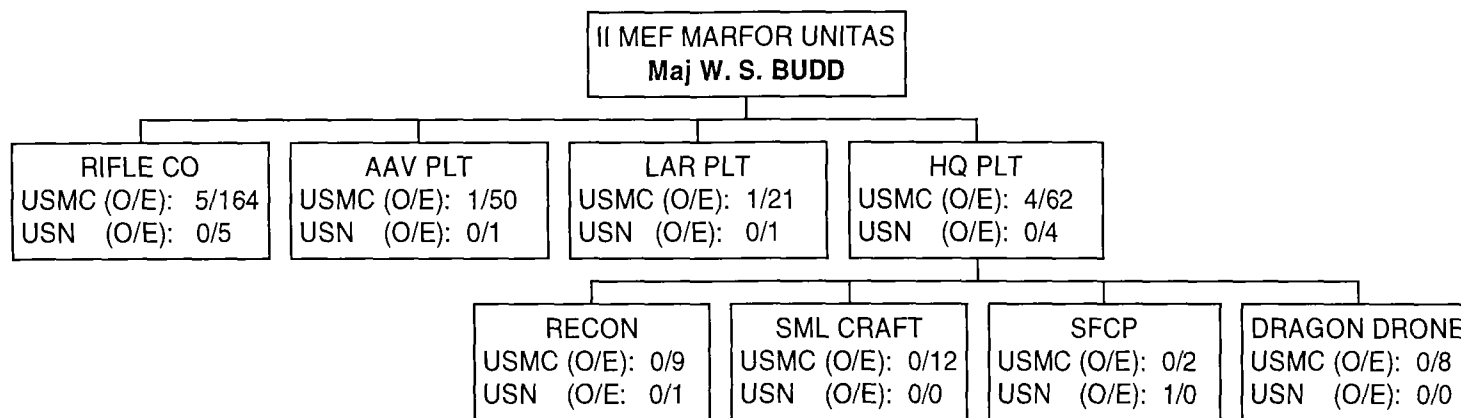

(C) ARMS AND EQUIPMENT IN POSSESSIONS: UNITAS PREDEP MSG 091300Z JUL 99			
NUMBER	ITEM	NUMBER	ITEM
13	AAV P-7	3	LAV-25
1	AAV R-7	1	LAV-L
1	AAV C-7		

Total O/H: 339

Future Plans: Conduct amphibious operations and combined cross training with emphasis on live fire training at Huacho, Peru.

Ref: UNITAS Predeployment msg 091300Z Jul 99. II MEF MARFOR UNITAS sitrep 5 270520Z Aug 99.



EUCOM

EUCOM DEPLOYMENTS

TOTAL DEPLOYED: 2,393*

SECRET

Operation Joint Forge (Ongoing) (EUCOM Theater)

UNIT	STRENGTH (O/E)	MISSION/STATUS
Det, VMU-2	0/7	Provide P-3 downlink imagery connectivity to COMSFOR.
Det, 4th CAG	3/10	Provide CA support to USA 353d CA Brigade.
Det, 4th FSSG	0/8	Provide Movement Control Support for Op Joint Forge.
Det, H&S BN, MCB CAMLEJ	0/1	MWDT for force protection of Task Force Eagle.
Augmentees	24	Individual augmentees provide support to COMSFOR.

Ref: MARFOREUR MSG 170910Z Aug 99/MFL Daily SitRep of 30 Aug 99.

Operation Northern Watch (30 Jun - 30 Sep) (Incirlik Turkey)

UNIT	STRENGTH (O/E)	MISSION/STATUS
Det, VMGR-352	7/33	Provide aerial refueling support for CTF-ONW CSAR aircraft.

Ref: MARFOREUR MSG 170910Z Aug 99 /MFP SitRep of 27 Aug 99.

FAST Security Support - (25 May - 25 Nov 99) (Naples, Italy)

OIC: Capt Lacroix

UNIT	STRENGTH (O/E)	MISSION/STATUS
3d Plt, 2d FAST Co	2/47	Providing security augmentation to COM6THFLEET.

Ref: MCSFBN Norfolk msg 161000Z Aug 99.

* Number includes MEU(SOC) in theater

SECRET

UNCLASSIFIED



CENTCOM DEPLOYMENTS
TOTAL DEPLOYED: 179

FAST Security Support - (02 Aug 99 - 01 Feb 00)
(Manama, Bahrain)

CO: Capt Viscuso

UNIT	STRENGTH (O/E)	MISSION/STATUS
5th Plt, 2d FAST Co	2/47	Providing security augmentation for COMFIFTHFLEET.

Ref: MCSFBN Norfolk msg 161000Z Aug 99.

Operation Resolute Response - (28 Jun - 30 Sep 99)
(Nairobi, Kenya)

OIC: 1stLt J. E. Sneed

UNIT	STRENGTH (O/E)	MISSION/STATUS
2d Plt(REIN), G Co, 2/7	1/59	Providing external security for the temporary American Embassy housed in USAID Building.

Ref: 2/7 Predeployment msg 241630Z Jun 99/MFP SitRep of 27 Aug 99.

JRAC - (Ongoing)
(Riyadh, Saudi Arabia)

OIC: N/A

UNIT	STRENGTH (O/E)	MISSION/STATUS
Det, I MEF	2	Elements assist in the coordination of all Counter Intelligence activities in the CENTCOM AOR.

Ref: MFP Weekly SitRep of 27 Aug 99. I MEF Sitrep 16-99 131616Z Aug 99.

JTF-SWA - (On going)
(Riyadh, Saudi Arabia)

OIC: N/A

UNIT	STRENGTH (O/E)	MISSION/STATUS
Det, I MEF	4	Provide force protection augmentation to the JTF-SWA Staff.

Ref: MFP Weekly SitRep of 27 Aug 99. I MEF Sitrep 16-99 131616Z Aug 99.



CENTCOM DEPLOYMENTS (continued)

SECRET

US MARCENT Coord Element (Ongoing)
(Manama, Bahrain)

OIC: N/A

UNIT	STRENGTH (O/E)	MISSION/STATUS
Det, MFP HQ Element	3	Providing MEU(SOC) and MFP exercise planning cell for forces operating in the CENTCOM AOR.

Ref: MFP Weekly SitRep of 27 Aug 99.

CJTF - Kuwait (Ongoing)
(Kuwait City, Kuwait)

OIC: N/A

UNIT	STRENGTH (O/E)	MISSION/STATUS
Det, I MEF	9	Providing force protection augmentation to CJTF- Kuwait Staff.

Ref: MFP Weekly SitRep of 27 Aug 99.

US Military Training Mission - (Ongoing) OIC: N/A
(Riyadh, Saudi Arabia)

UNIT	STRENGTH (O/E)	MISSION/STATUS
Det, 1st FSSG	1	Elements assist in the coordination of all Counter Intelligence activities in the CENTCOM AOR.

Ref: MFP Weekly SitRep of 27 Aug 99.

NAVCENT Force Protection Ops - (1 Mar - 1 Sep 99) OIC: N/A
(Manama, Bahrain)

UNIT	STRENGTH (O/E)	MISSION/STATUS
Det, HUMINT CO	3	Provides counterintelligence and HUMINT support for force protection issues for NAVCENT.

Ref: I MEF Sitrep 16-99 131616Z Aug 99.

SECRET

UNCLASSIFIED



CENTCOM DEPLOYMENTS (continued)

Carrier Integration (VMFA-323)
(Northern Arabian Gulf)

CO, VMFA-323: LtCol J.R. Keadle

UNIT	STRENGTH (O/E)	MISSION/STATUS
VMFA-323	187	Ops ISO Op Southern Watch through 14 Sep.

Ref: MFP Weekly SitRep of 27 Aug 99. CNO Notes of 30 Aug 99.



PACOM DEPLOYMENTS
TOTAL DEPLOYED: 2,879*

<u>FAST Security Support - (17 Aug 99 - 30 Jan 00)</u> <u>(Yokosuka, Japan)</u>		CO: Capt Mizell
UNIT	STRENGTH (O/E)	MISSION/STATUS
2d Plt, 1st FAST Co	2/44	Providing security augmentation for COMSEVENTHFLEET.
Ref: MCSFBN Norfolk msg 161000Z Aug 99.		
<u>JTF Full Accounting (Ongoing)</u> <u>(South East Asia)</u>		OIC: N/A
UNIT	STRENGTH (O/E)	MISSION/STATUS
Det, 9th ESB	1	Conduct investigations and recoveries to achieve the fullest possible accounting of Americans unaccounted for as a result of the war in South East Asia.
Ref: MFP Weekly SitRep of 27 Aug 99.		
<u>Humanitarian Demining (Ongoing)</u> <u>(Laos)</u>		OIC: N/A
UNIT	STRENGTH (O/E)	MISSION/STATUS
Det, 9th ESB	1	Providing instruction in EOD techniques for the Laotian Armed Forces.
Ref: MFP Weekly SitRep of 27 Aug 99.		



SOUTHCOM DEPLOYMENTS

TOTAL DEPLOYED: 753

<u>New Horizons - Haiti (18 May - 20 Nov)</u>		OIC: N/A
<u>(Port-au-Prince, Haiti)</u>		
UNIT	STRENGTH (O/E)	MISSION/STATUS
Det, MWSS-273	15	Providing crash, fire & rescue support to
Det, 2d IntelBn	64	COMUSSPTGRPHAITI at the Port-Au-Prince Airport.
Det. II MEF	215	CI Teams providing local AT monitoring.
<div style="display: flex; align-items: center;"> Ref: II MEF SitRep 20-99 132358Z Jul 99. MFL Daily SitRep of 30 Aug 99. <div style="font-size: small;"> <p style="margin: 0;">JTF Staffing</p> <p style="margin: 0;">to operation uphold democracy</p> </div> </div>		
<u>New Horizons - Nicaragua (15 May 99- 21 Aug 99)</u>		OIC: N/A
<u>(Esteli, Nicaragua)</u>		
UNIT	STRENGTH (O/E)	MISSION/STATUS
Det, MWSS-271	50	Providing civil affairs and engineer support to
Det, 4th CAG	20 (Rotational)	CINCSOUTH.
Ref: MFL Daily SitRep of 30 Aug 99.		
<u>JTF-B - Honduras (27 May - 07 Sep)</u>		OIC: N/A
<u>(Soto Cano AB, Honduras)</u>		
UNIT	STRENGTH (O/E)	MISSION/STATUS
Det, 4th CAG	1	Providing civil affairs support to JTF-B.
Ref: MFR Semi-Monthly 15-99 290610Z Jul 99.		



SOUTHCOM DEPLOYMENTS (continued)

Panama Canal Zone Security (27 May - 1 Sep)
(Howard AFB, PM)

OIC: Col Johnson

UNIT	STRENGTH (O/E)	MISSION
CJTF Panama	✓6/15	Provides security/force protection of U.S. Forces in JOA.
MARFOR-PM HQ	3 2 / 2	Co E providing security for US installations and facilities
Co E(REIN), 2/8	- 6/171	and high-value transit ships transiting the Panama
Det, SCCo	- 1/21	Canal and as an augmenting force to support
		USCINCSOUTH training initiatives, deployments and
		exercises.

Ref: MARFORSOUTH LN Element SitRep 13 200800Z Aug 99. II MEF SitRep 20-99 132358Z Aug 99.



15th MEU/Bonhomme Richard ARG
PHIBRON 3 - TBD (USN)
USS BONHOMME RICHARD (LHD-6)
USS DENVER (LPD-9)
USS PEARL HARBOR (LSD-52)
PRE- DEPLOYMENT PERIOD: 26 JUL 99 - 23 JAN 00
DEPLOYMENT PERIOD: 24 JAN 00 -24 JUL 00

Current Status: Continue predeployment training.

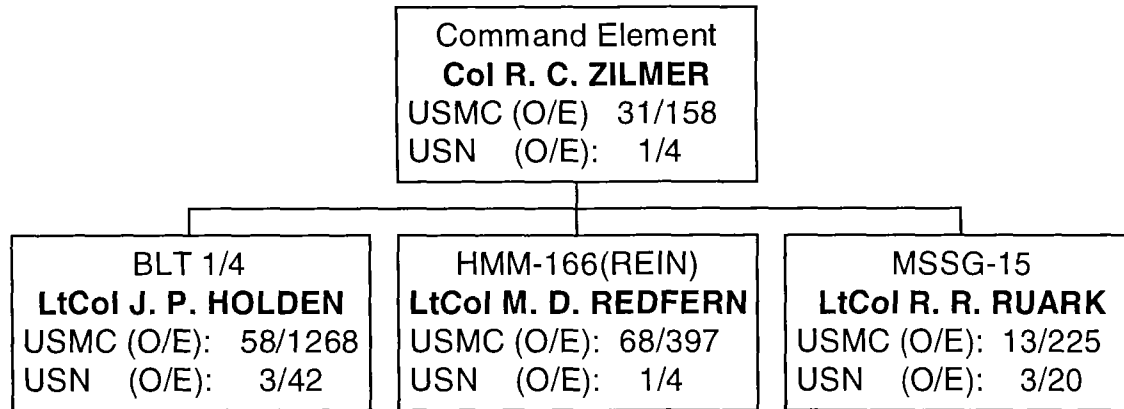

Total O/H: 2,295

Future Plans: Composite Unit Training Exercise (COMPTUEX), 20 Sep - 1 Oct
Ref: 15th MEU SitRep #04-99 of 200900Z Aug 99.



15th MEU/Bonhomme Richard ARG

PHIBRON 3 - TBD (USN)

USS BONHOMME RICHARD (LHD-6)

USS DENVER (LPD-9)

USS PEARL HARBOR (LSD-52)

PRE- DEPLOYMENT PERIOD: 26 JUL 99 - 23 JAN 00

DEPLOYMENT PERIOD: 24 JAN 00 -24 JUL 00

(C) ARMS AND EQUIPMENT IN POSSESSIONS:		15 TH MEU LOI 010116Z JUN 99	
NUMBER	ITEM	NUMBER	ITEM
13	AAV P-7	TBD	LAV-25
1	AAV R-7	1	LAV-C2
1	AAV C-7	2	LAV-L
6	M198	1	AN/MLQ-36A
1	M88	4	M1A1
(C) AIRCRAFT O/H:			
NUMBER	TYPE	NUMBER	TYPE
12	CH-46E	4	AH-1W
4	CH-53E	3	UH-1N
6	AV-8B	2	KC-130 (CONUS STANDBY)

(C) LANDING CRAFT:			
SHIP	NUMBER	TYPE	
USS BONHOMME RICHARD	TBD	TBD	
USS DENVER	TBD	TBD	
USS PEARL HARBOR	TBD	TBD	

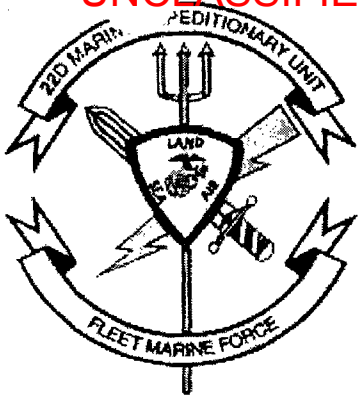

22^d MEU(SOC)/Bataan ARG
PHIBRON 4 - CAPT JASPER (USN)
USS BATAAN (LHD-5)
USS SHREVEPORT (LPD-12)
USS WHIDBEY ISLAND (LSD-42)

PRE- DEPLOYMENT PERIOD: 9 MAR - 16 SEP 99
DEPLOYMENT PERIOD: 17 SEP 99 - 16 MAR 00

Current Status: Block leave through 13 Sep.

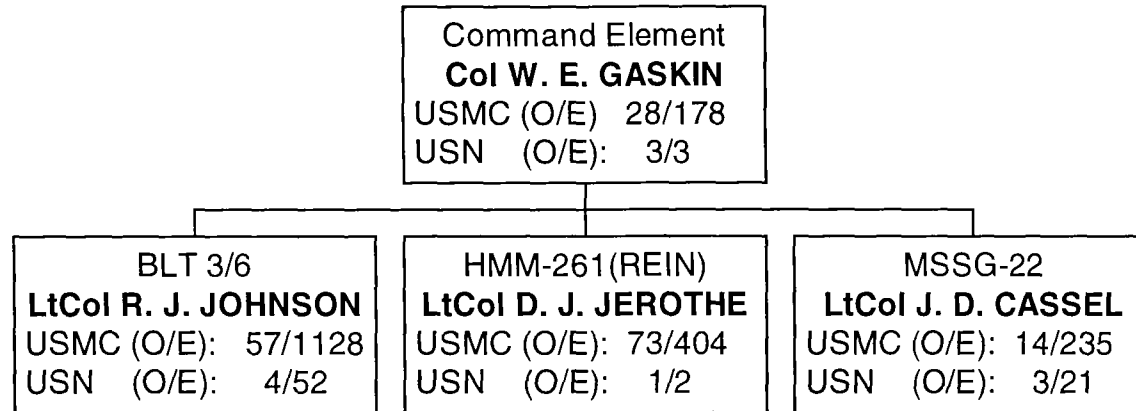

Total O/H: 2,206

Future Plans: Deployment Commences, 18 Sep.

Ref: 22^D MEU(SOC) SitRep #24 of 202235Z Aug 99.

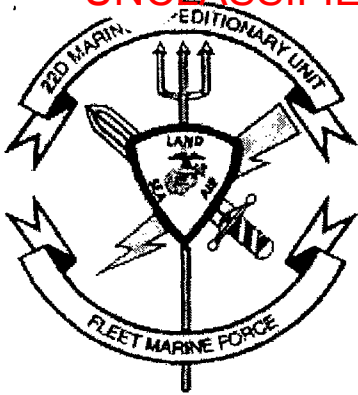

22^d MEU(SOC)/Bataan ARG
PHIBRON 4 - CAPT JASPER (USN)

USS BATAAN (LHD-5)

USS SHREVEPORT (LPD-12)

USS WHIDBEY ISLAND (LSD-42)

PRE- DEPLOYMENT PERIOD: 9 MAR - 16 SEP 99

DEPLOYMENT PERIOD: 17 SEP 99 - 16 MAR 00

(C) ARMS AND EQUIPMENT IN POSSESSIONS:		LF6F 1-00 LOI 181841Z FEB 99	
NUMBER	ITEM	NUMBER	ITEM
13	AAV P-7	4	LAV-25
1	AAV R-7	2	LAV(AT)
1	AAV C-7	1	LAV(L)
10	TOWS	1	AN/TSC-93
6	M198	1	AN/MLQ-36A
1	M88	4	M1A1
(C) AIRCRAFT O/H:			
NUMBER	TYPE	NUMBER	TYPE
12	CH-46E	4	AH-1W
4	CH-53E	2	UH-1N
6	AV-8B	2	KC-130 (CONUS STANDBY)

(C) LANDING CRAFT:			
SHIP	NUMBER	TYPE	
USS BATAAN	3	LCAC	
USS SHREVEPORT	1	LCU	
USS WHIDBEY ISLAND	2	LCAC	

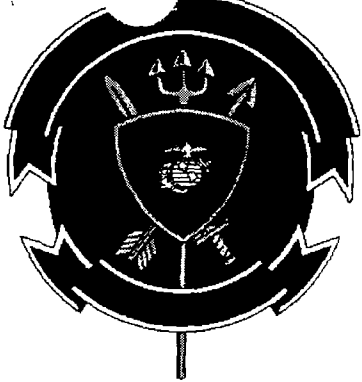

24th MEU/Wasp ARG
PHIBRON 8 - TBD (USN)
USS WASP (LHD-1)
USS TRENTON (LPD-14)
USS OAK HILL (LSD-51)

PRE- DEPLOYMENT PERIOD: 2 AUG - 16 FEB 00
DEPLOYMENT PERIOD: 17 FEB 00 - 18 AUG 00

Current Status: Command Element NBC Defense Training, 30 Aug. Scout Swimmer Course, 30 Aug - 10 Sep.

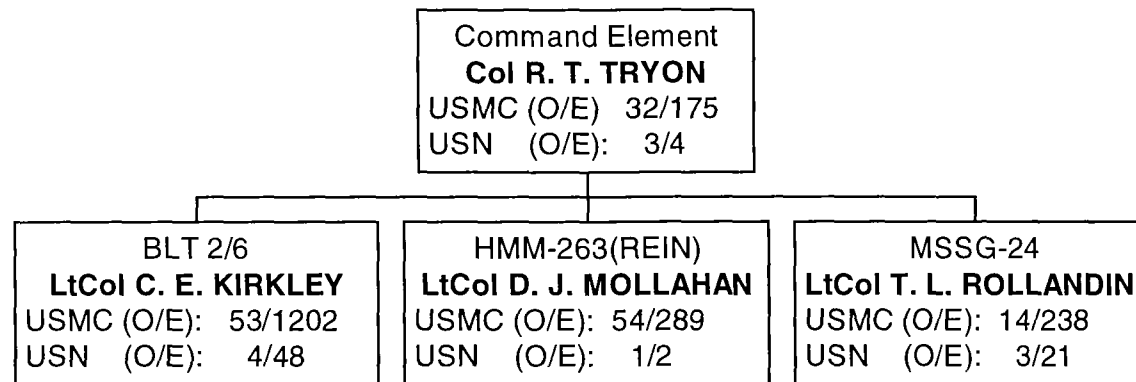

Total O/H: 2,143

Future Plans: TRUE at Ft. A. P. Hill, 8 - 24 Sep.

Ref: 24th MEU SitRep #03 of 192359Z Aug 99.

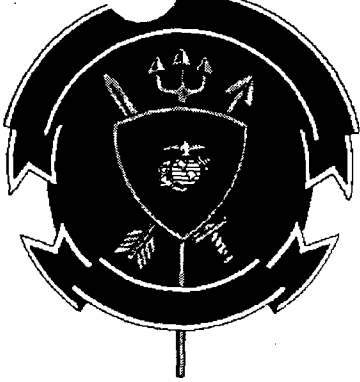

24th MEU/Wasp ARG
PHIBRON 8 - TBD (USN)
USS WASP (LHD-1)
USS TRENTON (LPD-14)
USS OAK HILL (LSD-51)

PRE- DEPLOYMENT PERIOD: 2 AUG - 16 FEB 00
DEPLOYMENT PERIOD: 17 FEB 00 - 18 AUG 00

(C) ARMS AND EQUIPMENT IN POSSESSIONS:		LF6F 2-00 LOI 291700Z JUN 99	
NUMBER	ITEM	NUMBER	ITEM
13	AAV P-7	4	LAV-25
1	AAV R-7	2	LAV(AT)
1	AAV C-7	1	LAV(L)
10	TOWS	1	AN/TSC-93
6	M198	1	AN/MLQ-36A
1	M88	4	M1A1
(C) AIRCRAFT O/H:			
NUMBER	TYPE	NUMBER	TYPE
12	CH-46E	4	AH-1W
4	CH-53E	2	UH-1N
6	AV-8B	2	KC-130 (CONUS STANDBY)

(C) LANDING CRAFT:			
SHIP	NUMBER	TYPE	
USS WASP	TBD	TBD	
USS TRENTON	TBD	TBD	
USS OAK HILL	TBD	TBD	



31st MEU(SOC)/Belleau Wood ARG
PHIBRON 11 - CAPT HAYES (USN)
USS BELLEAU WOOD (LHA-3)
USS DUBUQUE (LPD-8)
USS GERMANTOWN (LSD-42)

Current Status: BLT conducting jungle warfare training on Okinawa, 30 Aug - 3 Sep.

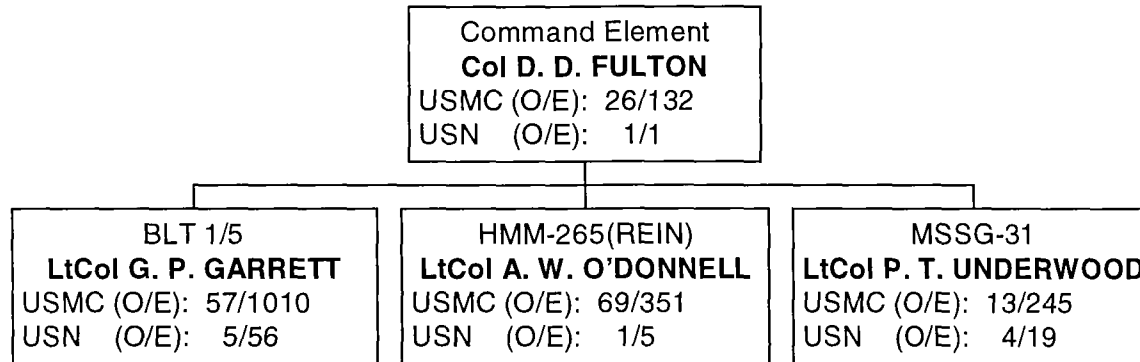

Total O/H: 1,986

Future Plans: Exercise Crocodile 99, Shoalwater Bay Training Area, Australia.
 Ref: 31st MEU SitRep 28-99 of 260731Z Jul 99.



31st MEU(SOC)/Belleau Wood ARG

PHIBRON 11 - CAPT HAYES (USN)

USS BELLEAU WOOD (LHA-3)

USS DUBUQUE (LPD-8)

USS GERMANTOWN (LSD-42)

(C) ARMS AND EQUIPMENT IN POSSESSIONS:			
NUMBER	ITEM	NUMBER	ITEM
12	AAVP-7A1	4	LAV-25
1	AAVR-7A1	2	LAV(AT)
1	AAVC-7A1	1	LAV(L)
6	M198	8	81MM MORTAR
8	TOWS		
(C) AIRCRAFT O/H:			
NUMBER	TYPE	NUMBER	TYPE
12	CH-46E	4	AH-1W
4	CH-53E	3	UH-1N
6	AV-8B	2	KC-130 (OKINAWA STANDBY)
(C) LANDING CRAFT:			
SHIP	NUMBER	TYPE	TYPE
USS BELLEAU WOOD	3		LCU
USS GERMANTOWN	3		LCAC
USS DUBUQUE	1		LCU

CONTINGENCY FORCES

I MEF

WEST PAC CONTINGENCY
EAST PAC CONTINGENCY
I MEF READY ARG

31ST MEU(SOC)
15TH MEU
USS BONHOMME
RICHARD ARG

ALERT MAGTF

CE: MEF(FWD)
GCE: 3/5
ACE: 3D MAW(FWD)
CSSE: 1ST FSSG(FWD)

II MEF

II MEF READY ARF
II MEF READY ARG

22^d MEU(SOC)
USS BATAAN ARG

ACF

CE: 6TH MAR(-)(REIN)
GCE: BLT 1/6
ACE: HMLA-167(REIN)
CSSE: CSSD-20

MPF

CE: II MEF (FWD)
CE: 6TH MAR(-)(REIN)
ACE: MAG-26(-)
CSSE: 2D FSSG(FWD)

FAST CONTINGENCY PLATOON: 6TH PLT, 1ST FAST CO

III MEF

WEST PAC CONTINGENCY
GCE: BLT 1/5(REIN)
ACE: HMM-265(REIN)
CSSE: MSSG-31

31ST MEU(SOC)
USS BELLEAU WOOD ARG

ALERT CONTINGENCY
MAGTF

CE: DET, HQ, 4TH MAR
GCE: 1/2
ACE: 1st MAW, HQ
CSSE: CSSD-39

FOLLOW-ON ALERT
CONTINGENCY MAGTF

CE: DET, HQ, 4TH MAR
GCE: 2/3
ACE: MACG-18
CSSE: CSSD-39

INFANTRY BATTALIONS - MARFORPAC

Unit	Deployment/Dates	Committed*	Returned**	Ops / Load trng	Future Deployment
1/1	<u>11th MEU(SOC)</u> Jun - Dec				<u>11th MEU</u> Jun - Dec 99
2/1			<input type="checkbox"/>		<u>11th MEU</u> Dec 00 - May 01
3/1				<input type="checkbox"/>	<u>13th MEU</u> Jul 00 - Dec 00
1/4		<u>15th MEU</u> Jan - Jul 00			<u>15th MEU</u> Jan - Jul 00
1/5	<u>UDP/31st MEU</u> Jun 99 - Jan 00				<u>UDP/31st MEU</u> Jun 99 - Jan 00
2/5				<input type="checkbox"/>	<u>UDP/31st MEU</u> Jan - Jul 00
3/5				<input type="checkbox"/>	<u>UDP/31st MEU</u> Jul - Dec 00
2/4			<input type="checkbox"/>		<u>UDP/31st MEU</u> Jul 00 - Jan 01
1/7				<input type="checkbox"/>	<u>UDP</u> Feb - Aug 00
2/7				<input type="checkbox"/>	<u>UDP</u> Aug 00 - Feb 01
3/7			<input type="checkbox"/>		<u>UDP</u> Feb - Aug 01
3/4	<u>UDP</u> Aug 99 - Feb 00				<u>UDP</u> Aug 99 - Feb 00
1/3				<input type="checkbox"/>	<u>UDP</u> Oct 99 - May 00
2/3	<u>UDP</u> Mar - Oct 99				<u>UDP</u> Mar - Oct 99
3/3			<input type="checkbox"/>		<u>UDP</u> May 00 - Dec 00

* - Lock-on 90 days for UDP/180 days for MEU

** - Keep on for 60 days

INFANTRY BATTALIONS - MARFORLANT

Unit	Deployment/Dates	Committed*	Returned**	Ops/Local Trng	Future Deployment
1/2	<u>UDP</u> Jun - Dec				<u>26th MEU</u> Oct 01 - Mar 02
2/2				<input type="checkbox"/>	<u>26th MEU</u> Jun - Dec 00
3/2				<input type="checkbox"/>	<u>UDP</u> Dec 99 - Jun 00
1/6				<input type="checkbox"/>	<u>UDP</u> Jun - Dec 00
2/6		<u>24th MEU</u> Feb - Aug 00			<u>24th MEU</u> Feb - Aug 00
3/6		<u>22d MEU</u> Sep 99 - Mar 00			<u>UDP</u> Jun - Dec 01
1/8			<input type="checkbox"/>		<u>22d MEU</u> Jul - Dec 00
2/8			<input type="checkbox"/>		<u>24th MEU</u> May - Oct 01
3/8	<u>26th MEU(SOC)</u> Apr - Oct 99				<u>UDP</u> Dec 00 - Jun 01

Marine Corps Total

Units	Deployed	Committed	Returned	Ops/Local Trng	
15	4	1	4	6	MARFORPAC
9	2	2	2	3	MARFORLANT
24	6	3	6	9	TOTAL

* - Lock-on 90 days for UDP/180 days for MEU

** - Keep on for 60 days after return

CURRENT I MEF EXERCISES

<u>EXERCISE</u>	<u>DATE</u>	<u>LOCATION</u>	<u>UNITS</u>	<u>REMARKS</u>
UFL 99	7 Aug - 4 Sep 99	Korea	Elements from I MEF	Joint training operation in support of OPLAN 5027.

FUTURE I MEF EXERCISES

<u>EXERCISE</u>	<u>DATE</u>	<u>LOCATION</u>	<u>UNITS</u>	<u>REMARKS</u>
DESFIREX 99	1 - 30 Sep	MCAGCC, 29 Palms, CA	11th MAR OCE 2/5 MCE	Regimental live fire support and coordination training exercise
DUTCH WARRIOR II	1 - 30 Sep	Camp Pendleton & MCAGCC, 29 Palms, CA	3d Plt, Force Recon	Bilateral reconnaissance training the Royal Netherlands Marine Corps and the USMC.

CURRENT II MEF EXERCISES

<u>EXERCISE</u>	<u>DATE</u>	<u>LOCATION</u>	<u>UNITS</u>	<u>REMARKS</u>
MWTC 7-99	7 Aug - 1 Sep 99	MCMWTC Bridgeport, CA	2d LAR Bn; 2d CEB; 2d AA Bn 2d Recon Bn	Summer Mountain Warfare Training.
CAX 10-99	23 Aug - 13 Sep 99	MCAGCC 29 Palms, CA	CE: 2d Mar(-)(REIN) GCE: 2/2(REIN) ACE: Det, MAG-31 CSSE: CSSD-27	Combined Arms Exercise.
DUTCH BILAT	30 Aug - 13 Sep	Curacao, The Netherlands	Det, SCCO	Annual bilateral exchange with The Royal Netherlands Marine \ Corps.

FUTURE II MEF EXERCISES

<u>EXERCISE</u>	<u>DATE</u>	<u>LOCATION</u>	<u>UNITS</u>	<u>REMARKS</u>
MWTC 8-99	7 Sep - ' 2 Oct	MCMWTC Bridgeport, CA	1/8	Summer Mountain Warfare Training Course

MARFORRES EXERCISES

<u>EXERCISE</u>	<u>DATE</u>	<u>LOCATION</u>	<u>UNITS</u>	<u>REMARKS</u>
UFL 99	12 Aug - 1 Sep 99	Korea	Dets: 4th FSSG; 4th MAW; 3d CAG	Joint training operation in support of OPLAN 5027.

FUTURE MARFORRES EXERCISES

<u>EXERCISE</u>	<u>DATE</u>	<u>LOCATION</u>	<u>UNITS</u>	<u>REMARKS</u>
TACTICAL FIGHTER WEAPONRY	6-25 Sep	Denmark	Dets: VMFA-242; VMFA-452	Joint Training Exercise
CAPABLE WARRIOR	13-23 Sep	Quantico, VA	4th LAR; 1/25; 3d ForceRecon; 4th SCAMP	Limited objective experiment IV.

CURRENT III MEF EXERCISES

<u>EXERCISE</u>	<u>DATE</u>	<u>LOCATION</u>	<u>UNITS</u>	<u>REMARKS</u>
SOUTHERN FRONTIER II	27 Jul - 8 Sep99	RAAF, Tindal, Australia	MAG-12(-) VMFA-212; Det, MALS-12 Det, VMGR-152 Det, MWSS-171 Det, MACS-4	MAG-sponsored squadron-level unit & combined training deployment.
FUJI 99-4	5 Aug - 23 Sep 99	Camp Fuji, Japan	1/2; Det, 4th Mar; Det, C Btry 1/12	Conduct individual & crew served, direct & indirect live fire and maneuver and combined arms training.
ARTY RELO 99-4	29 Aug - 2 Oct	Camp Fuji, Japan	CAB HqBtry, 12th Mar Btry L, 3/12 HQBtry, 3/12 Btry I, 5/10 CSSD-32	Artillery battery live fire training.

FUTURE III MEF EXERCISES

<u>EXERCISE</u>	<u>DATE</u>	<u>LOCATION</u>	<u>UNITS</u>	<u>REMARKS</u>
GAIT 99-9	13-17 Sep 99	Okinawa, Japan	Dets from: 3/4; MASS-2; Stinger Battery	Ground air integrated training.

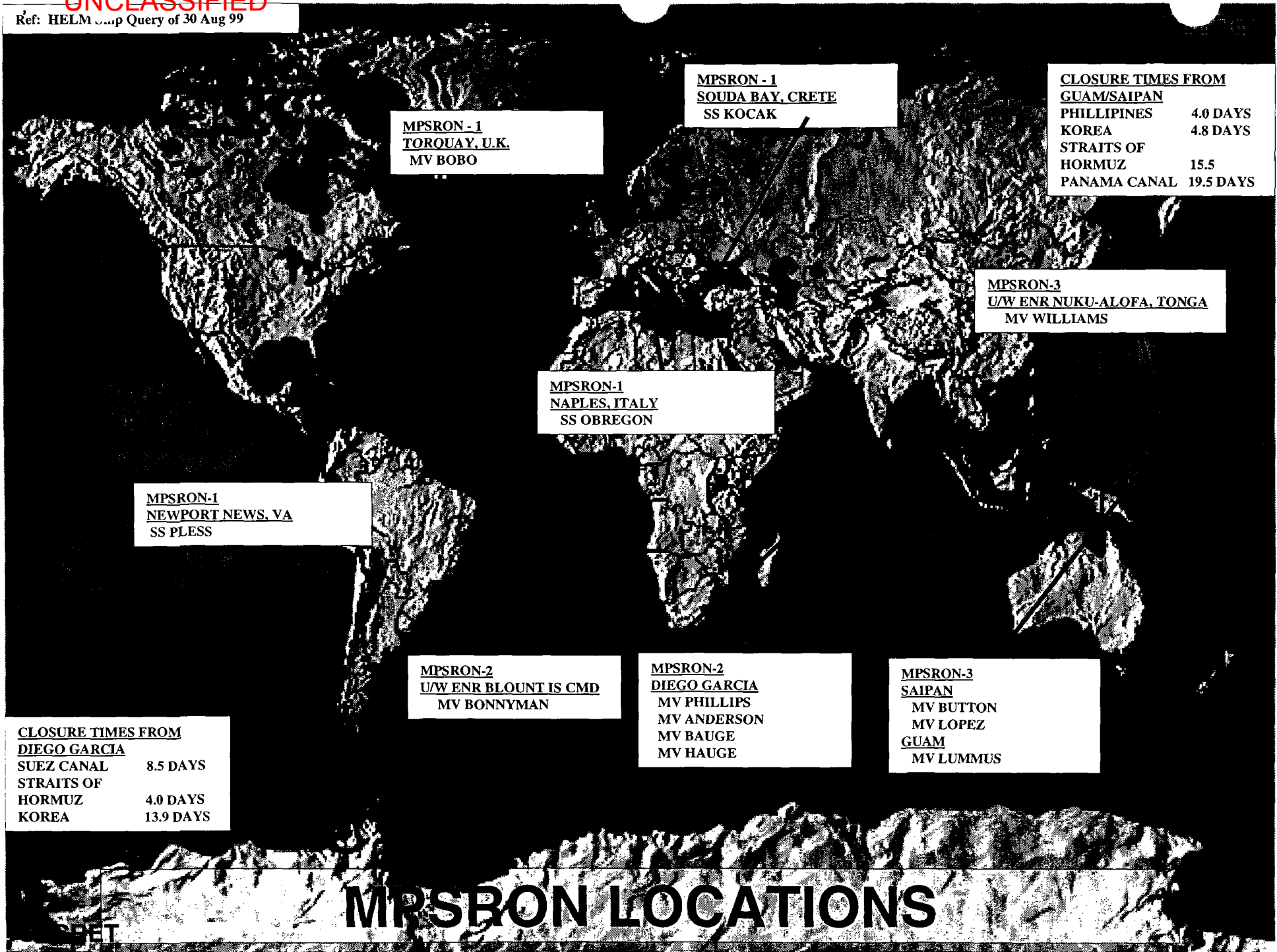

MPSRON - 1
TORQUAY, U.K.
 MV BOBO

MPSRON - 1
SOUDA BAY, CRETE
 SS KOCAK

<u>CLOSURE TIMES FROM</u>	
<u>GUAM/SAIPAN</u>	
PHILLIPINES	4.0 DAYS
KOREA	4.8 DAYS
STRAITS OF HORMUZ	15.5
PANAMA CANAL	19.5 DAYS

MPSRON-3
U/W ENR NUKU-ALOFA, TONGA
 MV WILLIAMS

MPSRON-1
NAPLES, ITALY
 SS OBREGON

MPSRON-1
NEWPORT NEWS, VA
 SS PLESS

MPSRON-2
U/W ENR BLOUNT IS CMD
 MV BONNYMAN

MPSRON-2
DIEGO GARCIA
 MV PHILLIPS
 MV ANDERSON
 MV BAUGE
 MV HAUGE

MPSRON-3
SAIPAN
 MV BUTTON
 MV LOPEZ
GUAM
 MV LUMMUS

<u>CLOSURE TIMES FROM</u>	
<u>DIEGO GARCIA</u>	
SUEZ CANAL	8.5 DAYS
STRAITS OF HORMUZ	4.0 DAYS
KOREA	13.9 DAYS

MPSRON LOCATIONS

CARRIER AIR INTEGRATION MEU/ARG PRESENCE

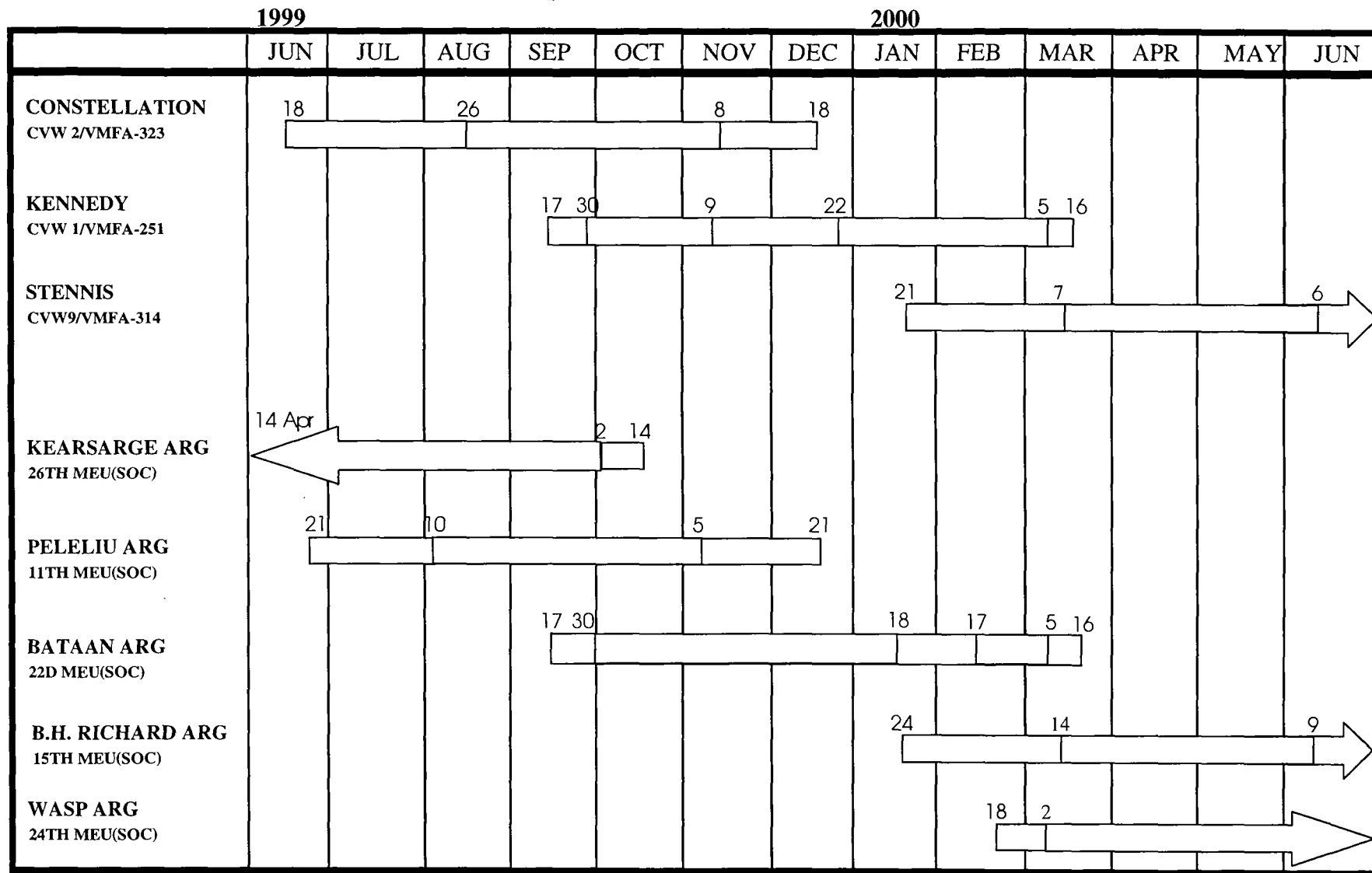

KEY

<input type="checkbox"/>	LANT TRANSIT	<input type="checkbox"/>	EUCOM
<input type="checkbox"/>	PAC TRANSIT	<input type="checkbox"/>	CENTCOM

ACTIVE FORCES AT PARENT COMMAND

<u>CAMP PENDLETON</u>		
<u>1st Mar</u>	<u>5th Mar</u>	<u>11th Mar</u>
1/1# 2/1#	1/5& 2/5	1/11 (A, B, C)
3/1 1/4	3/5 2/4	2/11(E&, F, G)
		5/11(R, S, T)
<u>MAG-39</u>		
HMLA-169*	HMLA-267	HMLA-367
HMLA-369	HMT-303	HMM-364# HMM-268

<u>YUMA</u>		
<u>MAG-13</u>		
VMA-211	VMA-214	VMA-311^
VMA-513	VMU-1@	

<u>MIRAMAR</u>		
<u>MAG-11</u>		
VMFA(AW)-121	VMFA(AW)-225	
VMFA(AW)-242*	VMFAT-101	VMGR-352
VMFA-232	VMFA-323+	VMFA-314+
<u>MAG-16</u>		
HMH-361	HMH-462	HMH-465*
HMH-466	HMM-161	HMM-163
HMM-164	HMM-165#	HMM166

<u>FUTENMA/IWAKUNI</u>	
<u>MAG-36</u>	<u>MAG-12</u>
VMGR-152	VMFA-212
HMM-262	
HMM-265^	

<u>29 PALMS</u>	
<u>7th Mar</u>	<u>11th Mar</u>
1/7 2/7	3/11(I, K, L 3/12*)
3/7 3/4*	
1st Tank Bn	

<u>HAWAII</u>		
<u>3d Mar</u>	<u>12th Mar</u>	<u>1st MAW ASE</u>
1/3 2/3* 3/3	1/12 (A,B,C*)	HMH-362 HMH-363
	K, 3/12 (Okinawa)	HMH-366 HMH-463
		HMT-301

<u>BEAUFORT</u>			
<u>MAG-31</u>			
VMFA-115*	VMFA-122	VMFA-251+	VMFA-312
VMFA(AW)-224	VMFA(AW)-332	VMFA(AW)-533	

<u>CAMP LEJEUNE</u>		
<u>2d Mar</u>	<u>6th Mar</u>	<u>8th Mar</u>
1/2* 2/2 3/2	1/6 2/6# 3/6#	1/8 2/8 3/8#
<u>10th Mar</u>		
1/10 (A, B, C)	2/10 (E, F, G)	3/10 (I, K, L)
5/10 (R, S, T, I 3/12*)		
2d Tank Bn		

<u>CHERRY POINT</u>		
<u>MAG-14</u>		
VMAQ-1	VMAQ-2	VMAQ-3**
VMAQ-4	VMA-223	VMA-231
VMA-542	VMGRT-253	VMAT-203
VMGR-252	VMU-2@	

<u>NEW RIVER</u>		
<u>MAG-26</u>		
HMLA-167	HMM-261#	HMM-264
HMM-266#	HMH-461	HMT-204
<u>MAG-29</u>		
HMLA-269	HMM-162	HMM-263#
HMM-365#	HMH-464	HMT-302

KEY: & - UDP ISO 31ST MEU * - CURRENT UDP UNIT @-OPERATIONAL DEPLOYMENT ** - PTDO STATUS
 ^ - ACFT ISO 31ST MEU + - CARRIER INTEGRATION # - MEU MSE

RESERVE FORCES AT PARENT COMMAND

GROUND UNITS

INFANTRY BATTALIONS

<u>23D Marines</u> (San Rafael, CA)	<u>24th Marines</u> (Kansas City, MO)	<u>25th Marines</u> (Worcester, MA)
1/23 (Houston, TX)	1/24 (Detroit, MI)	1/25 (Camp Edwards, MA)
2/23 (Encino, CA)	2/24 (Chicago, IL)	2/25 (Garden City, NY)
3/23 (New Orleans, LA)	3/24 (Bridgeton, MO)	3/25 (Brookpark, OH)

TANK BATTALIONS

4th Tank Bn (San Diego, CA)	8th Tank Bn (Rochester, NY)
-----------------------------	-----------------------------

AVIATION UNITS

FIXED WING SQUADRONS

<u>MAG-41</u> (Dallas, TX)	<u>MAG-42</u> (Marietta, GA)	<u>MAG-46</u> (Miramar, CA)	<u>MAG-49</u> (Willow Grove, PA)
VMA-124 (Dallas, TX)	VMFA-142 (Cecil Field, FL)	VMFA-134 (Miramar, CA)	VMA-131 (Willow Grove, PA)
VMFA-112 (Dallas, TX)		VMFT-401 (Yuma, AZ)	VMFA-321 (Andrews AFB, MD)
VMGR-234 (Ft Worth, TX)			VMGR-452 (Stewart, NY)

ROTARY WING SQUADRONS

<u>MAG-42</u> (Marietta, GA)	<u>MAG-46</u> (Miramar, CA)	<u>MAG-49</u> (Willow Grove, PA)
HMLA-773 (Marietta, GA)	HMM-764 (El Toro, CA)	HMH-772 (Willow Grove, PA)
HMM-774 (Norfolk, VA)	HMLA-775 (Camp Pendleton, CA)	
HMLA-775, Det A (Belle Chasse, LA)		

GROUND/AVIATION UNIT DEPLOYMENT PROGRAM

1999

2000

	JUN	JUL	AUG	SEP	OCT	NOV	DEC	JAN	FEB	MAR	APR	MAY	
INF BN	3/7		3/4					1/7					
3D AA BN	2/3					1/3							
ARTY BN	Co D (REIN)					Co A (REIN)							
F/W SQDN	C, 1/12					A, 1/12							
HELO SQDN	VMFA(AW)-242					VMFA-232					VMFA(AW)-225		
INF BN	HMLA-169							HMLA-369					
ARTY BN	HMH-465							HMH-462					
F/W SQDN	VMFA(AW)-224					VMFA-115					VMFA(AW)-332		
INF BN	1/2							3/2					
ARTY BN	I, 3/12					T, 5/10							
3D LAR BN	1/5							2/5					
ARTY BN	E, 2/11							K, 3/12					
3D LAR BN	Co B							Co D					

KEY	<input type="checkbox"/>	EAST COAST	<input type="checkbox"/>	UDP ISO 31ST MEU
	<input type="checkbox"/>	WEST COAST		



MCSFBN
NORFOLK, VA (20/193)
1ST FAST CO
NORFOLK, VA (11/274)

2D FAST CO
YORKTOWN, VA (10/256)

MCSF CO
KEFLAVIK, ICELAND (2/64)

MARINE BARRACKS
8TH & I (4/233)

MCSF CO
LONDON UNITED KINGDOM (3/83)

MCSF CO
NAPLES, ITALY (2/63)

MCSF CO
BANGOR, WA (9/431)

MCSF CO
ASU, BAHRAIN (6/142)

MCSF TRNG CO
CHESAPEAKE, VA (8/79)

MCSF CO
PATUXENT RIVER, MD (2/80)

MCSF CO
ROTA, SPAIN (2/67)

MARINE BARRACKS
GUANTANAMO BAY, CUBA (20/375)

MCSF CO
KINGS BAY, GA (10/382)

MCSF CADRES
6 OVERSEAS/10 CONUS (1/75)

MARINE CORPS SECURITY
FORCES BATTALION TOTAL:
(106/2,698)

MARINE CORPS SECURITY FORCES

COUNTERDRUG OPERATIONS

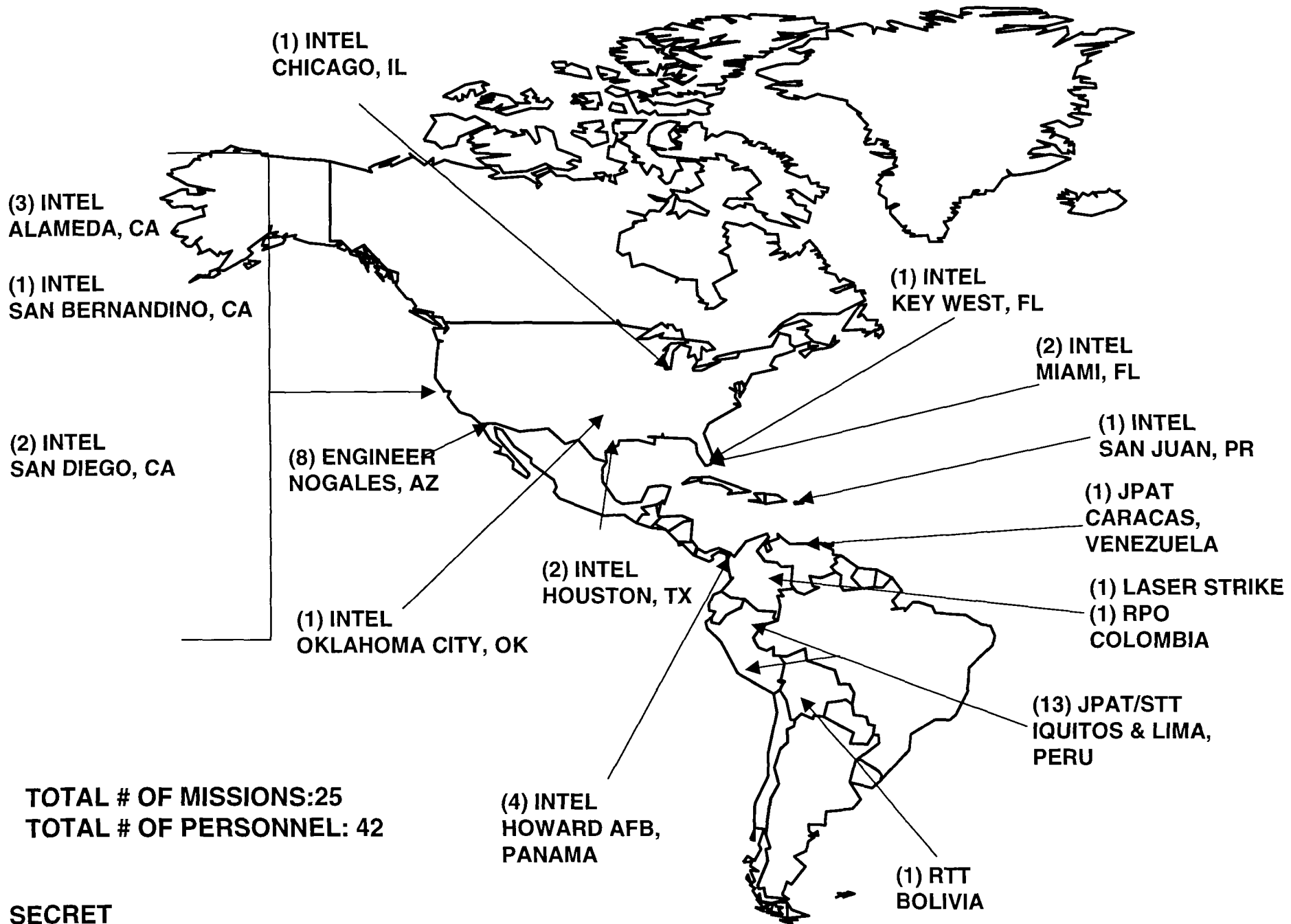

TOTAL # OF MISSIONS: 25
 TOTAL # OF PERSONNEL: 42