

DECLASSIFIED

UNCLASSIFIED

HEADQUARTERS

3d Battalion, 3d Marines, Marine #23  
3d Marine Division (Rein) FMF  
c/o Fleet Post Office  
San Francisco, California, 96601

3d MARDIV (FWD)  
S+C # ~~1608-65~~  
3/JAD/eaw  
3100  
Ser No: 0061-65  
3 September 1965

From: Commanding Officer  
To: Commanding Officer, Fourth Marines  
Subj: Command Diary for period 1 - 31 August 1965  
Ref: (a) DivO 3100.1

1. In accordance with reference (a) the Command Diary for this organization covering the period 1-31 August 1965 is submitted herewith.

*J. E. Muir*  
J. E. MUIR

UNCLASSIFIED

DECLASSIFIED

UNCLASSIFIED

## PART I

## ORGANIZATION DATA SHEET

UNCLASSIFIED

1. Reporting Unit. 3d Battalion, 3d Marines, 3d Marine Division, FMF
2. Period Covered by Report. 1 August 1965 to 31 August 1965
3. Date of Submission of Report. 5 September 1965
4. Commanding Officer. Lieutenant Colonel JOSEPH E. MUIR
5. Location of Command Post at End of Period. Coordinates (BT 530022) CHU LAI
6. Map. AMS Series L701, Sheet 6757III
7. Subordinate Unit Commanders

3d Bn 3d Marines		LtCol J. E. MUIR
H&S Co. 3d Bn, 3d Marines	1 August - 23 August 1965	Lt G.C. LAWTY
	24 August - 31 August 1965	Capt. P.W. DEMARTIN
Co "I", 3d Bn, 3d Marines	1 August - 18 August 1965	Capt. B.D. WEBB
	18 August - 23 August 1965	Lt R. M. FURNELL
	24 August - 31 August 1965	Capt. D.A. RAMSEY
Co "K", 3d Bn, 3d Marines	1 August - 22 August 1965	Capt. J. A. DOUB
	23 August - 31 August 1965	Capt. G.V. GARDNER
Co "L", 3d Bn, 3d Marines		Capt. J.E. MCDAVID
Co "M", 3d Bn, 3d Marines		Capt. C. M. MORRIS

UNCLASSIFIED

UNCLASSIFIED

## PART II

## NARRATIVE SUMMARY

1. GENERAL

a. At the beginning of the period 3d Bn 3d Marines was in a defensive position within its TAOR conducting patrols and ambushes. The Battalion CP was located at (BT 566044). Extensive patrolling was conducted forward of the MLR with results varying from no contact to engagement with Viet Cong forces up to company size. Patrols were conducted twenty-four (24) hours a day, ranging from squad to company size. In addition numerous layouts and ambushes were established. Three combat outposts and a traffic control point were manned forward of the MLR. On 18-20 August the battalion participated in Operation STARLIGHT as one of the assault battalions. On 27 August 1965, 3d Bn 3d Marines was relieved in its MLR positions by the 1st Bn 7th Marines. The battalion moved into a tactical bivouac area as prescribed by 3d Bn 3d Marines Frag Order #35. Frag Order #35 was modified and two (2) platoons from Company "L" were assigned to assist Company "I" in airfield defense. 3d Bn 3d Marines retains operational control of both companies and is responsible for the airfield defense in assigned sector. The Bn CP is located at (BT 530022). CP security is provided by H&S Company, one (1) platoon from Company "M" and the battalion's attached tank and Ontos platoons.

b. Aggressive civil affairs action was aimed at the local hamlets within the TAOR. Whenever possible medical aid, food and gifts were distributed in areas of need. Noticeable achievements in the civil affairs program were evident as village searches and hamlet visits were met with firendliness and cooperation.

c. The battalion continued saturation patrolling and searches of areas in an attempt to net VC. Often the battalion's offensive endeavors were favorable in that the searches resulted in the apprehension and destruction of confirmed Viet Cong and his logistical support.

d. On 2 August 1965, the battalion executed 3d Bn 3d Marines Operation Order 9-65 which was a defensive order assigning missions to the companies within the assigned TAOR. On 6 August 1965 the battalion executed 3d Bn 3d Marines Operation Order 10-65 which was a two day search and destroy operation in conjunction with elements of the 51st Regiment, 2d ARVN Division, and the 3d Vietnamese Marine Battalion. Operation Plan 11-65 provided for a night helicopter operation on the TRUNG PHAN Peninsula, however, it was not executed due to a lack of available aircraft. On 14 August 1965, 3d Bn 3d Marines Operation Order 12-65 was executed ordering a helicopter operation on the TRUNG PHAN Peninsula. The mission was to conduct daytime search and destroy operations and night platoon ambushes. 3d Bn 3d Marines Operation Order 13-65 was published but never executed because of other operational commitments. On 17 August, the battalion executed RLT-7 Operation Order 323-65 which was further amplified by 3d Bn 3d Marines Operation Order 14-65. The operation consisted of an opposed amphibious landing and a search and destroy operation in an area heavily concentrated with Viet Cong.

UNCLASSIFIED

2. MISSIONS ASSIGNED

a. The battalion continued to execute the missions assigned in 4th Marines

UNCLASSIFIED

Frag Order #10-65 of 25 July 1965. Until 27 August 1965, these missions were:

- (1) Occupy and defend along the trace of the MLR in the left sector of the Regimental TAOR.
- (2) Maintain OPLR's within sector.
- (3) Maintain traffic control point to check and control movement of civilians and vehicles through the sector.
- (4) Provide liaison personnel to effect positive coordination with the 2d ARVN Division, Quang Ngai.
- (5) Provide one (1) Rifle Company as Regimental Reserve.
- (6) Conduct and maintain surveillance of seaward approaches within sector, repel overt landings and prohibit infiltration.
- (7) Be prepared to provide one (1) battalion (-) on order for employment as a reaction force to be helilifted or road transported anywhere in the Division Zone.

### 3. OPERATION PARTICIPATION

a. During the reporting period the majority of the offensive actions enacted by the battalion were in the form of saturation patrolling of the assigned TAOR.

(1) On 6-7 August 1965, the battalion participated in Operation THUNDERBOLT. The mission was to search out and destroy all Viet Cong and his logistical support. The operation netted six (6) VC captured. Weapons captured included two (2) carbines and four (4) bounding type mines.

(2) On 17-20 August, 3d Bn 3d Marines executed Operation STARLIGHT. The mission entailed making an amphibious assault landing followed by a rapid movement inland to seek out and destroy the Viet Cong. The battalion killed 215 VC and captured 20 POW's during this operation.

### 4. TERRAIN AND WEATHER

a. Terrain. Terrain within our TAOR is accurately configured on the TRI BINH and SON TRA maps (Series L701, Sheets 6757III and 6757II, compiled by the Army Map Service). As seen, it is gently rolling sand dunes, interspersed with small pine trees, rice paddies, stone temples and huts. West of the Song Tra Bong River, roads have been constructed which permit vehicular traffic to most areas. The highest hill within the TAOR is 141 meters and is located on the East shore of the Trung Phan Peninsula. The terrain east of the Song Tra Bong is rougher and has a heavy growth of underbrush on the high ground.

UNCLASSIFIED



~~UNCLASSIFIED~~

b. Weather. During the month of August there was no rain until the 26th, but from the 26th through the 31st, 5.63 inches of rain was recorded. Temperatures ranged from 70 degrees Fahrenheit to 100 degrees Fahrenheit with a mean temperature of 87 degrees and an average humidity of 78%. Predominate surface winds were from East ~~South~~ East at eight (8) knots. Cloud cover during daylight hours has been minimal permitting almost continuous air operations. Precipitation and cloud cover greatly increased during the latter part of the month, and it is expected to continue increasing through the month of September and October at which time we anticipate the monsoon season. The most reliable estimates indicate the average annual rainfall for this area is about 70 inches.

## 5. MORALE AND DISCIPLINE

a. Food Service. All companies are maintaining individual messes capable of serving "A" or "B" rations as provided by the battalion mess. Both quality and quantity of food has increased greatly during the reporting period. Morale in this area: Excellent.

### b. Liberty and R&R Program

(1) There is no liberty in the Chu Lai area due to location and operational requirements.

(2) The R&R program for this battalion had a quota of 114 for the month. The program is running smoothly. Morale in this area: Excellent.

c. Mail Service Mail service is on a daily basis but still out of sequence. The granting of the free mail privilege has given a great boost to morale. Morale in this area: Excellent.

d. Pay. The men are paid regularly but usually draw only enough for PX supplies and beer. Signing of the pay bill has increased morale. Morale in this area: Excellent.

e. PX Supplies. All units are serviced by the PX truck. PX supplies remain poor in selection and quantity. Morale in this area: Poor.

f. Religious Services. Religious services are held each Sunday for both Protestants and Catholics. Attendance is good and consistent with operational requirements. Morale in this area: Good.

g. Special Services. Due to the displacement of the Battalion CP special service facilities are practically nonexistent. Morale in this area: Poor.

h. Discipline. Disciplinary actions continue to be reduced. Morale in this area: Excellent.

NJP -1

SCM - 5

SPCM -2

~~UNCLASSIFIED~~

II-3 UNCLASSIFIED

UNCLASSIFIED

PART III  
CHRONOLOGICAL NARRATIVE

1 August 1965. Company "M" continued operations on the TRUNG PHAN Peninsula. The company made no VC contact and was retracted by seven (7) LVT's at 0915H. The company moved to the airfield and reverted to Regimental Reserve, relieving Company "K" who reoccupied its former position on the MLR. Companies "I" and "L" remained in position on the MLR and conducted extensive patrolling to the front. At 1710H in the vicinity of OP #1 (BT 560996) a VC threw an M-26 gran at three (3) Marines setting out trip flares and booby traps, resulting in all three (3) being wounded. Two (2) rounds of SA fire was delivered at the fleeing VC with no positive results although some blood was detected. All wounded evacuated by helicopter to "B" Med.

2 August 1965. Companies conducted patrols and ambushes forward of the MLR. Co "M" moved to the MLR and Co "K" reverted to Regimental Reserve. Co "I" moved by LVT to the TRUNG PHAN Peninsula in an attempt to locate the mother of a girl wounded in an encounter with the VC on 31 July. The search proved negative. One (1) platoon from Force Recon was left on the peninsula where they gathered intelligence on any enemy movement.

3 August 1965. Companies conducted active patrolling to the front of the MLR. A detachment from 1st Force Recon (-) operated during the day on the TRUNG PHAN Peninsula. Arty furnished H&I fires throughout the night within the assigned Battalion TAOR. Co "M" was assigned an alert posture to recover Force Recon elements from the TRUNG PHAN Peninsula. At 031920H Recon requested to be evacuated from peninsula (BT 625002) when confronted with a force of twenty-three (23) armed VC. Two (2) platoons of Co "M" were dispatched, but were unable to make contact with the now dispersed VC. At 032000H Co "M" returned to the Bn CP with the Recon Team. At 032005H a second Force Recon Team was retracted from (BS 628975) at which time the helicopter in LZ received SA fire from (BS 629973).

4 August 1965. Companies "I", "L", & "M" conducted patrols and ambushes along and to the front of the MLR. Company "M" with the Battalion Chaplain moved to the TRUNG PHAN Peninsula in LVT's to search for the mother of a young girl wounded on the 31st of July. The search proved fruitful and the mother was brought back and reunited with her daughter. Artillery provided H&I fires throughout the night within the assigned TAOR.

5 August 1965. Companies "I", "L", & "M" again conducted patrols and ambushes along the MLR. The battalion made preparations for the execution of Operation Order 10-65. At 051940H arty fire was delivered on VCS unloading a boat at (BT 644052). Thirty-six (36) rounds were fired with good effect on target area.

6 August 1965. Companies maintained security on the MLR. At 060700H the battalion executed Operation Plan 10-65. (Operation "THUNDERBOLT"). Co's "L" & "K" occupied the vacated positions of Companies "I" & "M" on the MLR. At 060823H Co "I" reported being at LZ WOLF and capturing one (1) VCS at (BS 518858). At 060954H, Co "M" reported receiving SA fire from village of TRA BINH (BS 535858). No casualties. At 060950H Co "M" reported being on objective "A" with four (4) VCS that had been captured vic (BS 548858). Co "I" also reported discovering seven (7) packs (BS 536859). At 061100H, ARVN L19 reported a

UNCLASSIFIED

DECLASSIFIED

UNCLASSIFIED

platoon of VC moving in a column south vic (BS 510875). At 061317H Co "I" reported finding three (3) packs with clothes and food and one (1) carbine with five (5) magazines at (BS 552961). A second carbine was found at (BS 534857) on a dead VC. At 061335H, Company "I" reported receiving twelve (12) rds SA fire vic (BS 532865). No casualties. Co "I" also reported finding eight (8) bounding type mines at same coord. Engineers destroyed all eight (8). At 062010H, Co "I" reported two (2) Marine WIA's from booby trap. One (1) was evacuated and the other returned to duty. At 062330H Co "I" on the MLR reported one (1) Marine with light graze in upper right forearm. WIA occurred as a result of a stray round from PF fire-fight at (BS 565994).

7 August 1965. The battalion continued the execution of Operation THUNDERBOLT, Operation Cedar 10-65. At 070930H Company "L" uncovered a chinese fragmentation grenade at (BS 587865). It was not booby trapped. Operation THUNDERBOLT concluded at 071330H. During the operation Companies "K" and "L" maintained security on the MLR supported by tanks.

8 August 1965. Companies conducted patrols and ambushes along the MLR. Co "M" conducted a equal size amphibious patrol along the SONG TRA BONG River, searching 160 sampans.

9 August 1965. Companies continued to patrol and set ambushes along the MLR. Company "L" prepared a static rifle company display in preparation for General WESTMORELAND's visit to CHU LAI on 10 August. At 092245H OP #1 received SA fire. One (1) VC was killed. Artillery provided illumination during the encounter.

10 August 1965. At 100245H, four (4) tanks and three (3) LVT's moved 2500 meters West down the beach in an effort to force any VC in the area to move into previously established ambush positions located (BS 603013) and (BS 582977). Co "L" provided a static display for General WESTMORELAND's visit at the CHU LAI airstrip.

11 August 1965. At 110645H Co "I" commenced search and destroy operations on the TRUNG PHAN Peninsula. The company received several rds of SA fire during the operation, and arty was called for and delivered with good effect on two (2) occasions. Security of the MLR remained the responsibility of Co's "L" and "M" with Co "K" in Regimental Reserve. At 111800H, in the evening resupply run, one (1) helicopter received sniper fire from (BS 629992).

12 August 1965. Co "I" was retracted from a successful search and destroy operation on the TRUNG PHAN Peninsula at 120800H. Security of the MLR was maintained. The Division Commander inspected Co "M" on the MLR.

13 August 1965. An orientation tour was conducted at the MAG-12 complex and the 12th Marines area to allow 3/3 Officers and SNCO's to become more familiar with supporting arms units. Security was maintained on the MLR.

14 August 1965. At 140847H Co "M" landed by helicopter on the TRUNG PHAN Peninsula (BT 666996) and commenced search and destroy operation. Numerous pieces of equipment were captured the most notable being a Russian HE Rocket Launcher with two (2) rds of ammunition. Patrols and ambushes were conducted along the MLR. Co "K" remained in Regimental Reserve.

III-II  
UNCLASSIFIED

DECLASSIFIED

UNCLASSIFIED

15 August 1965. Companies "I" and "L" maintained security on the MLR. At 150230H Co "I" sent a platoon to the vic (BS 553998) to form a blocking position for a morning search of TBI BINH (1) (BS 555981). At 150600H the remainder of the company searched the hamlet with negative results. Company "M" was retracted from the TRUNG PHAN Peninsula at 151300H. Patrolling on the West side of the SONG TRA BONG River produced negative results.

16 August 1965. The battalion continued active patrolling along the MLR and West of the SONG TRA BONG River. During the night tanks were utilized to provide H&I fires. At 160300H 1st Plat Co "L" received one (1) grenade at (BF 549013). No casualties were sustained.

17 August 1965. At 171000H Company "M" boarded LVT's and departed for the TRUNG PHAN Peninsula to conduct search and destroy operations and to take up blocking position in conjunction with Operation STARLIGHT. The remainder of the battalion boarded U.S. Naval ships during the late afternoon and evening and sailed for the objective area.

18-19 August 1965. Operation STARLIGHT started as a routine search and destroy operation, which escalated into a BLT offensive action. At 160630H the BLT landed with Company "I" on the left flank and Company "K" on the right in LVT's. Company "M" in reserve landed in LCU's and LCM 8's. Tanks and Ontos were also landed in the scheduled waves. Brisk action continued during the day and at 181600H Company "L" 5d Battalion, 7th Marines landed and were placed under operational control of BLT 3/3. On the morning of the 19th BLT 3/3 received a Frag Order narrowing its zone of action to the east and continuing the attack to the sea in zone. The battalion jumped off to the north with Company "K" on the left, Company "L" on the right and Company "M" 3/7 in reserve at 190700H. The zone of action was prepared with heavy gunfire and artillery prior to the commencement of the attack. The battalion moved forward against sporadic resistance which became intense during the late morning hours. Heavy concentrations of air, artillery and naval gunfire were employed to silence VC defenders, and the battalion returned to the previous night's position. During the night, heavy H&I fires were provided by artillery and naval gunfire.

20 August 1965. The battalion continued operation STARLIGHT. No enemy fire was received on the return sweep to Beach GRAM. The battalion was relieved by 1/7 and returned by U. S. Navy Ships to CHU LAI. It returned to defensive positions on the MLR and continued patrolling between the MLR and the SONG TRA BONG River. The only contact during the night was carbine fire received by a Co "M" patrol vic (BF 605015). No casualties were reported. Full information on Operation STARLIGHT is contained in After-action Report #33.

21 August 1965. The battalion continued to improve defensive positions along the MLR. Companies conducted ambushes forward of their positions.

22 August 1965. Active patrolling was carried out by all units. At 221030H a platoon of Company "M" and three squads of Engineers with mine detectors searched the beach area from our MLR to the SONG TRA BONG River for indications of mine emplacement. Reports had been received of large number of VC moving North from BINH SON with intentions of mining the area. Investigation proved Negative.

UNCLASSIFIED

UNCLASSIFIED

23 August 1965. The battalion continued to improve defensive positions along the MLR. Co "I" moved to Regimental Reserve and Co "A" occupied its vacated positions on the MLR; active patrolling to the front of the MLR was carried out.

24-25 August 1965. All units continued to improve defensive positions along the MLR. At 250830H Co "L" reported receiving one (1) round sniper fire at (BT 573017). No casualties. At 252140H Co "K" received one rd SA fire (BT 555001). No casualties. Active patrolling to the front of the MLR was carried out.

26 August 1965. The battalion continued extensive patrolling forward of its MLR. During the day-light hours Co "L" conducted a search and clear operation on the TRUNG PHAN Peninsula. At 261300H at (BT 655006) an empty cave about twenty (20) feet long was destroyed by Engineers attached to Co "L". There was no enemy contact and the company returned to the MLR at 261500H. At 261855H Co "K" apprehended three (3) VCS at (BT 558014) and delivered them to the collection point.

27 August 1965. The battalion was relieved on the MLR by 1st Bn, 7th Marines. Companies were moved into a tactical bivouac behind the MLR.

28 August 1965. The 1st Bn, 7th Marines completed relief of the MLR. Three (3) companies were in a tactical bivouac behind the MLR and Co "I" remains in Regimental Reserve.

29-30-31 August 1965. The battalion continued to assume the defensive responsibility for the Western to the Northern end of the airfield with Co "I" and two (2) platoons from Co "L". The remainder of the battalion remained in a tactical bivouac. Each company sent nine (9) marines to a 60mm Mortar School being conducted by the 81mm Mortar Platoon.

UNCLASSIFIED

III-IV

## PART IV

SUPPORTING DOCUMENTS

1. - 3/3 Operation Order 9-65
2. - 3/3 Operation Order 10-65
3. - 3/3 Operation Order 11-65
4. - 3/3 Operation Order 12-65
5. - 3/3 Operation Order 13-65
6. - 3/3 Operation Order 14-65
7. - 3/3 Frag Order 35-65
8. - 3/3 After Action 31-65
9. - 3/3 After Action 32-65
10. - 3/3 After Action 33-65 (Opn STARLIGHT)
11. - Overlay Legend for period 311200H July - 071200 August 1965
12. - Overlay Legend for period 071200H - 141200H August 1965
13. - Overlay Legend for period 141200H - 211200H August 1965
14. - Overlay Legend for period 211200H - 281200H August 1965
15. - Lessons learned on Operation "THUNDERBOLT"
16. - 3/3 Journal for month of August 1965 (28 Aug NIF)
17. - SOP for Intelligence
18. - Equipment, Weapons, and POW's captured by 3/3 on Operation "STARLIGHT"
19. - Patrol Report 1st FT 3d Sqd 1st Plat Co "L"
20. - Patrol Report 3d Plat Co "I"
21. - Patrol Report ~~1st~~ Plat Co "L"
22. - Patrol Report 3d Sqd Co "M"
23. - Patrol Report 1st FT 1st Sqd 1st Plat Co "L"
24. - Patrol Report 1st FT 2nd Sqd 1st Plat Co "M"
25. - Patrol Report 3d Sqd 2nd Plat Co "I"
26. - Patrol Report 1st Sqd ~~2nd~~ Plat Co "M"
27. - Patrol Report 3d Plat Co "I"
28. - Patrol Report 1st & 3d Sqd 2nd Plat Co ~~"I"~~ Co "M"
29. - Patrol Report 1st & 2nd Sqd 1st Plat Co "L"
30. - Patrol Report 3d Sqd 2nd Plat Co "M"
31. - Patrol Report 3d Sqd 2nd Plat Co "I"
32. - Patrol Report 2nd FT 2nd Sqd 2nd Plat Co "ZU"
33. - Patrol Report 3d Plat Co "I"
34. - Patrol Report 2nd Plat Co "L"
35. - Patrol Report Sqd 106RR Plat H&S Co
36. - Patrol Report 1st Sqd 3d Plat Co "M"
37. - Patrol Report Sqd H&S Co
38. - Patrol Report 3d Sqd 2nd Plat Co "M"
39. - Patrol Report 1st Plat Co "I"
40. - Patrol Report 3d Plat Co "L"
41. - Patrol Report 3d 3d Sqd 3d Plat Co "M"
42. - Patrol Report 1st Sqd 2nd Plat Co "M"
43. - Patrol Report 2nd Sqd 1st Plat Co "M"
44. - Patrol Report 2nd Sqd 2nd Plat Co "M"
45. - Patrol Report 3d Sqd 1st Plat Co "M"
46. - FT 106RR Plat H&S Co

- 47. - Patrol Report 1st Sqd 1st Plat Co "M"
- 48. - Patrol Report Sqd 106RR Plat H&S Co
- 49. - Patrol Report 1st Plat Co "I"
- 50. - Patrol Report 1st Sqd 2nd Plat Co "M"
- 51. - Patrol Report 2nd Plat Co "I"
- 52. - Patrol Report Sqd 106RR Plat H&S Co
- 53. - Patrol Report 1st Plat Co "I"
- 54. - Patrol Report 3d Plat Co "I"
- 55. - Patrol Report 3d Sqd 1st Plat Co "M"
- 56. - Patrol Report 1st Sqd 1st Plat Co "M"
- 57. - Patrol Report FT 106RR Plat H&S Co
- 58. - Patrol Report 1st Sqd 3d Plat Co "I"
- 59. - Patrol Report FT 106RR Plat H&S Co
- 60. - Patrol Report 3d Sqd 2nd Plat Co "I"
- 61. - Patrol Report FT 106RR Plat H&S Co
- 62. - Patrol Report 3d Plat Co "I"
- 63. - Patrol Report 2nd Plat Co "I"
- 64. - Patrol Report 3d Plat Co "I"
- 65. - Patrol Report 3d FT 2nd Sqd 2nd Plat Co "L"
- 66. - Patrol Report 3d Sqd 2nd Plat Co "L"
- 67. - Patrol Report FT 106RR Plat H&S Co
- 68. - Patrol Report 1st Plat Co "L"
- 69. - Patrol Report 2nd FT 1st Sqd 2nd Plat Co "L"
- 70. - Patrol Report 3d Sqd 2nd Plat Co "L" Co "I"
- 71. - Patrol Report 3d Plat Co "I"
- 72. - Patrol Report 2nd Plat Co "L"
- 73. - Patrol Report 3d Sqd 1st Plat Co "L"
- 74. - Patrol Report 2nd FT 3d Sqd 2nd Plat Co "L"
- 75. - Patrol Report 2nd FT 1st Sqd 1st Plat Co "L"
- 76. - Patrol Report 3d Plat Co "M"
- 77. - Patrol Report 2nd Sqd 2nd Plat Co "L"
- 78. - Patrol Report 2nd Plat Co "I"
- 79. - Patrol Report 3d Sqd 1st Plat Co "L"
- 80. - Patrol Report Sqd 106RR Plat H&S Co
- 81. - Patrol Report 1st Plat Co "L"
- 82. - Patrol Report 2nd Plat Co "M"
- 83. - Patrol Report 2nd Plat Co "L"
- 84. - Patrol Report 1st Plat Co "K"
- 85. - Periodic Personnel Report #12
- 86. - Periodic Personnel Report #13
- 87. - Periodic Personnel Report #14
- 88. - Periodic Personnel Report #15
- 89. - Periodic Logistic Report #10
- 90. - Periodic Logistic Report #11
- 91. - Periodic Logistic Report #12
- 92. - Periodic Logistic Report #13

3d Bn (Apt) 3d Marines  
 CHU LAI, VIETNAM  
 021200H August 1965

**Operation Order 9-65**

Ref: (a) 4th Marines Frag Order #10-65

(b) Map: VIETNAM; 1:50,000, AMS Series L701, Sheet 6757II, 6757III, 6756I

Time Zone: H

1. SITUATION

a. Enemy Forces. Viet Cong forces in CHU LAI area are capable of attacking 3/3 positions in strength varying from individual infiltration to seven (7) battalions. Each effort could be supported with 60mm, 81mm and 4.2 inch mortars and/or 105mm howitzers.

b. Friendly Forces

(1) 4th Marines continues to defend CHU LAI airfield and to support logistical facilities in the Regimental TAOR.

(2) 2/4 on the night (West) flank.

(3) 3d Platoon, Co. "A", 3d Tank Bn. DS.

(4) 3d Platoon, Co. "B", 3d AT Bn. DS.

c. Attachments and Detachments. None.

2. MISSION. 3/3 occupies and defends assigned portion MLR; maintains traffic control point on Route #1; provides liaison personnel to 2nd ARVN Division, QUANG NGAI; assigns one company to Regimental Reserve; maintains surveillance over seaward approaches; and prepares for operations anywhere in Division zone.

3. EXECUTION

a. Concept of Operation. 3/3 occupies MLR with three (3) companies on line occupying platoon strong points. Establishes mobile combat outposts 1000-1500 meters in front of MLR. Patrols aggressively throughout business sector.

b. First Company

(1) Occupy defensive positions battalion right (South) flank (BT 545013) to (BT 559018).

(2) Maintain contact with 2/4 on right (South) flank.

(3) Tie in with second Company on left (North) flank.

(4) Establish and maintain traffic control point at (BT 553013).



- (5) Occupy OP vicinity (BT 560996) with minimum one (1) reinforced rifle squad.

c. Second Company

- (1) Occupy defensive positions center sector of MLR (BT 559018) to (BT 569023).
- (2) Tie in with First Company on the right (South) and Third Company on the left (North).
- (3) Maintain mobile OP vicinity (BT 575007) with minimum one (1) rifle squad.

d. Third Company

- (1) Occupy defensive positions battalion left (North) flank (BT 559023) to (BT 578034).
- (2) Tie in with Second Company on right (South) flank.
- (3) Maintain OP vicinity (BT 583029).

e. 81mm Mortar Platoon, H&S Company, Annex B (Fire Support)

f. 106mm Recoilless Rifle Platoon, H&S Company

- (1) General Support
- (2) Occupy positions vicinity Battalion OP.

g. Fourth Company

- (1) Regimental Reserve
- (2) Reference (a)

h. Coordinating Instructions

- (1) Assignment of companies
- (a) First Company - Company "I"
- (b) Second Company - Company "L"
- (c) Third Company - Company "M"
- (d) Fourth Company - Company "K"
- (e) Subsequent reassignments by Frag Order
- (2) Patrol Zones: Annex A (Defense Overlay).

[REDACTED]

- (3) Defensive positions based on platoon strong points with all-around security.
- (4) Wire around strong points will be interconnecting.
- (5) Priority of work:
  - (a) Clear fields of fire
  - (b) Automatic weapons positions
  - (c) Individual positions
  - (d) Wire obstacles
  - (e) Bunkers
  - (f) Communications trenches
  - (g) Camouflage continuous
- (6) Living spaces behind MMR camouflaged and either below ground or behind sandbags.
- (7) Submit overlay of company positions and defensive fire plans.
- (8) Annex A (Defense Overlay)
- (9) Annex B (Fire Support)
- (10) Annex C (Counter-attack Plan)

#### 4. ADMINISTRATION AND LOGISTICS

##### a. Supply

- (1) General. Unit commanders submit timely requests for logistic support.
- (2) Supplies and Equipment available
  - (a) Class I.
    - 1. MMR companies maintain twenty (2) cases MCI's on position.
    - 2. Second Company operate company mess at Company CP. Feed 81 plat (-).

[REDACTED]

3. Third Company operate mess at Company CP.
4. First Company operate company mess at Company CP.
5. H&S Company operate mess for Battalion (-) and attachments.

(b) Class II. Normal

(c) Class III. Those companies operating mess obtain resupply of fuel for burners from the Battalion motor transport POL dump.

(d) Class IV. Consolidated requirements for organic units have been submitted to higher headquarters. Upon receipt, materials will be distributed based on priorities established.

(e) Class V. Maintain B/A per individual.

(f) Water. Water point located at this CP.

(3) Control and Distribution

(a) Supply point distribution.

(b) Battalion supply maintain one (1) BA Class V on hand in the dump with exceptions of following: 4 DOA 81m and 1 DOA 100 M and 3.5.

(4) Resupply. Normal

(5) Air Delivery. Resupply by air on request. Helicopters must be scheduled by 1530 the day prior to delivery.

(6) Captured Material. Evacuate captured material to this CP and turn it in, with accompanying information, to the S-2.

(7) Salvage. All class IV and inoperable equipment will be salvaged.

b. Evacuation and Hospitalization. Normal

4. Transportation

(1) Requests for organic transportation to the Battalion MTO (dispatcher)

(2) Requests for non-organic transportation (trucks and LVT's) to this headquarters (S-4 as soon as requirements become evident. Consolidated truck requests are submitted to higher headquarters by 1730 the day prior to scheduled use, so routine requests must be in by that time.

d. Service. Maximum use will be made of contact teams when appropriate. Submit timely requests to this headquarters (S-4).

e. Personnel

- (1) Strengths. Units will utilize all available personnel in defense of MLR.
- (2) Prisoners of War. After initial processing by the S-2 all POW's will be evacuated to the Regimental Collection Point.
- (3) Graves Registration. All KIA's will be processed through the Battalion Aid Station. Unit commanders insure that personal effects are inventoried within twenty-four hours after evacuation.
- (4) Morale and Personnel Services

a. A PX truck will continue to service units every Monday at each Company CP. Schedules will be promulgated by telephone.

b. Religious services for those desiring to attend will be announced.

- (5) Civil Affairs - Military Government. Civilians entering the MLR will be apprehended and checked for proper identification. In the event that an individual does not possess proper identification or appears suspicious, he will be escorted to the Battalion Collection Point.

- (6) Personnel Procedures

a. Reports of battle casualties will be submitted to the S-1 as soon as operational requirements permit.

f. Miscellaneous

- (1) Submit ammo expenditure reports to the S-4 via telephone prior to 0800 daily. Negative reports required.
- (2) Submit missing weapons reports via telephone to the S-4 immediately upon discovery.
- (3) Close attention to inventory of personal effects.

5. COMMAND AND COMMUNICATIONS - ELECTRONICS

a. Bn. CP (BT 567042).

b. Companies report CP locations.

c. Communications. Maximum use of wire. Alternate lines to all positions.

CONFIDENTIAL

*Joseph E. Muir*

JOSEPH E. MUIR  
Lieutenant Colonel, U. S. Marine Corps  
COMMANDING

Annexes:

- A - Defense Overlay
- B - Fire Support
- C - Counter-attack Plan (To be issued)

DISTRIBUTION: Special

CONFIDENTIAL

Annex A (Defense Overlay) to Operation  
Plan 9-65

3d (A) 5d Marines  
CHU LAI, VIETNAM  
021200H August 1965

Ref: Map: VINT NAM; 1:50,000, Series L701,  
Sheets 6757II, 6757III

Time Zone: H

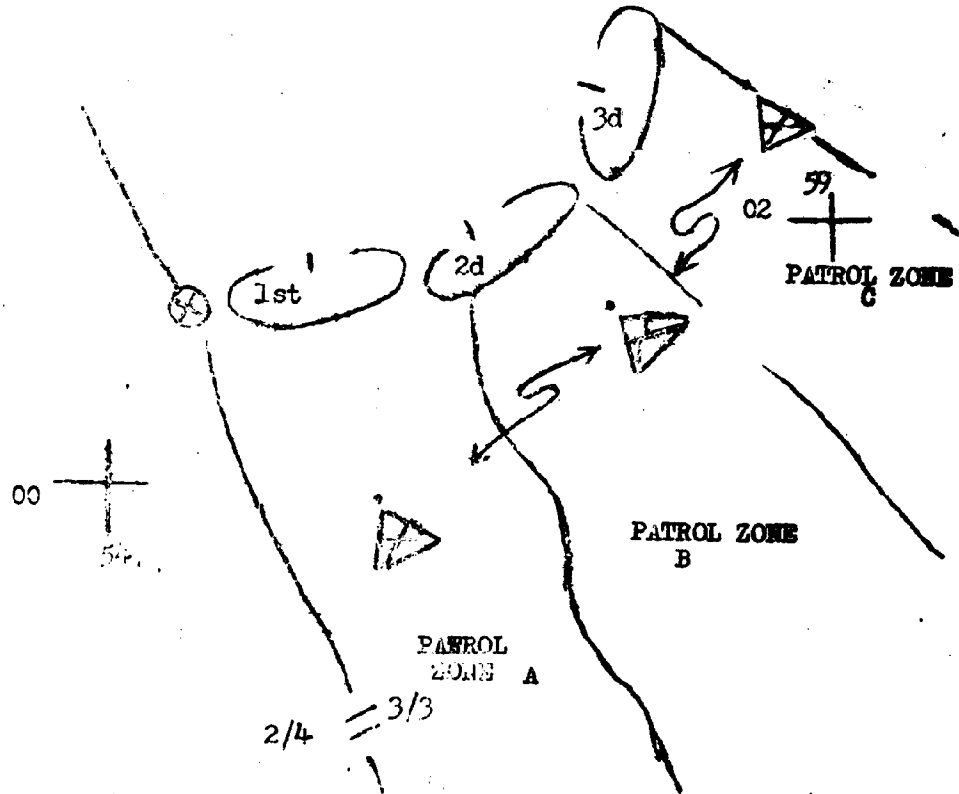
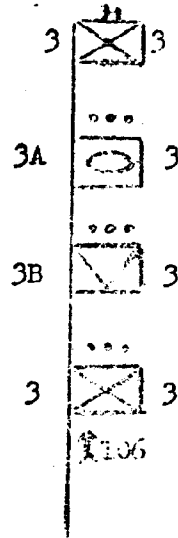

BY COMMAND OF LIEUTENANT COLONEL MUIR

*L. G. Comer*  
L. G. COMER

Major, U. S. Marine Corps  
Executive Officer

DISTRIBUTION: Special

A-1

3d Bn (Rein) 3d Marines  
 CHU BI, VIETNAM  
 021200Z August 1965

Annex B (Fire Support Plan) to Operation Order 9-65

Ref: Map; VIETNAM, 1:50,000, Series L701, Sheets 6757II, 6757III, 6756I

Time Zone: H

1. SITUATION. See Basic Order.
2. MISSION. Provide fire support for defense of MLR in 3d Bn 3d Marines sector of responsibility.
3. EXECUTION.
  - a. 81mm Mortar Platoon
    - (1) General Support.
    - (2) Occupy primary firing positions vicinity (BT 560023).
    - (3) Provide all around security for platoon position.
    - (4) Prepare alternate positions.
    - (5) Provide one barrage for each of the MLR companies.
    - (6) Pre-Planned concentrations for on call fires (Appendix 2)
  - b. Btry "C", 1st Bn, 12th Marines
    - (1) General Support, 4th Marines. Priority of fires 3/3.
    - (2) Provides one barrage to 3/3.
    - (3) Pre-Planned concentrations for on call fires. (Appendix 1).
  - c. 4.2" Btry, 3d Bn, 12th Marines
    - (1) General Support, 3d Bn, 12th Marines.
    - (2) Provides one barrage to 3/3 (Appendix 1).
  - d. Btry "K", 4th Bn, 12th Marines
    - (1) General Support, 4th Marines.
    - (2) Provides one barrage to 3/3 (Appendix 1).
  - e. 1st 8" Howitzer Plat, 1st 8" Howitzer Btry, FMFPAC
    - (1) General Support, 4th Marines.

3d Bn (Rein) 3d Marines  
 CHU LAI, VIETNAM  
 021200H August 1965

Appendix 1 (On Call Fires) (Arty) to Annex B (Fire Support) to Operation Order 9-65

Ref: (a) Map; VIETNAM, 1:50,000, Series L701, Sheets 6757II, 6757III,  
 6756I

Time Zone: H

<u>CONCENTRATION #</u>	<u>COORDINATES</u>	<u>TARGET</u>
CC 100	552001	Trail
CC 104	552996	Trail
CC 105	551989	Crit Terrain
CC 106	543989	Trail Junction
CC 107	544982	Trail
CC 108	567997	Crit Terrain
CC 109	555998	Crit Terrain
CC 110	554003	Crit Terrain
CC 114	546007	Crit Terrain
CC 115	551005	Crit Terrain
CC 116	560012	Village
CC 117	560995	Ave of Approach
CC 207	572021	Ave of Approach
CC 208	577026	Trail
CC 209	580030	Ave of Approach
CC 210	584019	Trail
CC 211	589022	Stream Bed
CC 422	573015	Trail
CC 423	580008	Ave of Approach
"C" Barrage	558012-566011	Ave of Approach
"W" Barrage	549010-550011	Ave of Approach
"K" Barrage	557996-557998	Ave of Approach

BY COLONEL OF MAJORITY COLONEL MUIR

*A. G. Comer*  
 A. G. COMER  
 Major, U. S. Marine Corps  
 Executive Officer

TAB:

A - Overlay On Call Defensive Fires (Artillery)

DISTRIBUTION: Special

B-1-1



321 (Helm) 3d Marines  
CHU BI, VIETNAM  
021200H August 1965

Tab A (On Call Defensive Fires (Arty)) To Appendix I (On Call Fires)  
Tab A and B (Arty Support) To Operation Plan 9-65

Ref: Map: WHEMAN; 1:50,000, AMS Series L701, Sheet 6757II, 6757III, 6756I

Time Zones: H

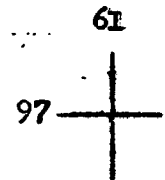
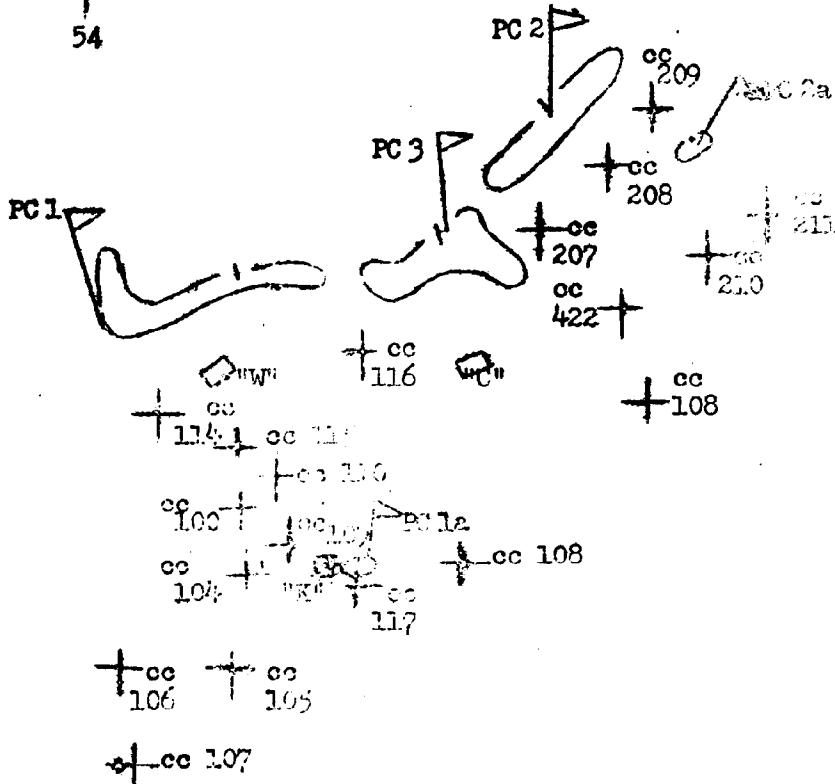
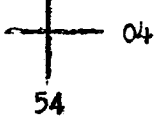

BY COMMAND OF LIEUTENANT COLONEL MUIR

*A. G. Conner*

A. G. CONNER  
Major, U. S. Marine Corps  
Executive Officer

DISTRIBUTION: Special

DECLASSIFIED

3d Bn (Rein) 3d Marines  
 CHU LAI, VIETNAM  
 021200H August 1965

Appendix 2 (On Call Fires) (81mm) to Annex B (Fire Support) to Operation  
 Order 9-65

Ref: Map: VIETNAM; 1:50,000 Series 1701, Sheets 6757II, 6757III, 6756I

Time Zone: H

<u>B/CO</u>	<u>COORDINATES</u>	<u>COMPANY</u>	<u>NATURE OF TARGET</u>	<u>MAX. ORDINATE</u>
B-1	557996	India	Ave. of approach	4741 Ft
B-2	559014	India	Ave. of approach	1722 Ft
B-3	573022	Kilo	Co. boundry	1945 Ft
B-4	578030	Kilo	Ave. of approach	2270 Ft
B-5	564014	Lima	Ave. of approach	2850 Ft
B-6	568011	Lima	Ave. of approach	2535 Ft
301	550011	India	Trail Junc./Village	3047 Ft
302	557010	India	Hwy #1	2351 Ft
304	544020	India	Trail Junc.	2950 Ft
305	552021	India	Trail Junc.	1650 Ft
306	546007	India	High Ground	4412 Ft
307	557007	India	High Ground	3778 Ft
308	553000	India	Trail Junc/ Ave.App	4360 Ft
309	559994	India	Ave. of approach	4419 Ft
327	574024	Kilo	Ave. of approach	1722 Ft
328	576026	Kilo	Trail	2535 Ft
330	576032	Kilo	Ave. of approach	3250 Ft
351	570016	Lima	Dead Space	3350 Ft
Bn	568042	Bn Defense	ave. of approach	3047 Ft

BY COMMAND OF LIEUTENANT COLONEL MUIR

*A. G. Comer*  
 A. G. COMER  
 Major, U. S. Marine Corps  
 Executive Officer

TAB:

A - Overlay On Call Defensive Fires (81mm)

DISTRIBUTION: Special

B-2-1

DECLASSIFIED

3d Bn (Rein) 3d Marines  
CHU LAI, VIETNAM  
021200H August 1965

Tab A (On Call Defensive Fires (81mm))  
To Appendix 2 (On Call Fires)  
To Annex B (Fire Support), to Operation Plan 9-65

Ref: Map: VIETNAM; 1:50,000, Series L701, Sheets 6757II, 6757III, 6756I

Time Zone: H

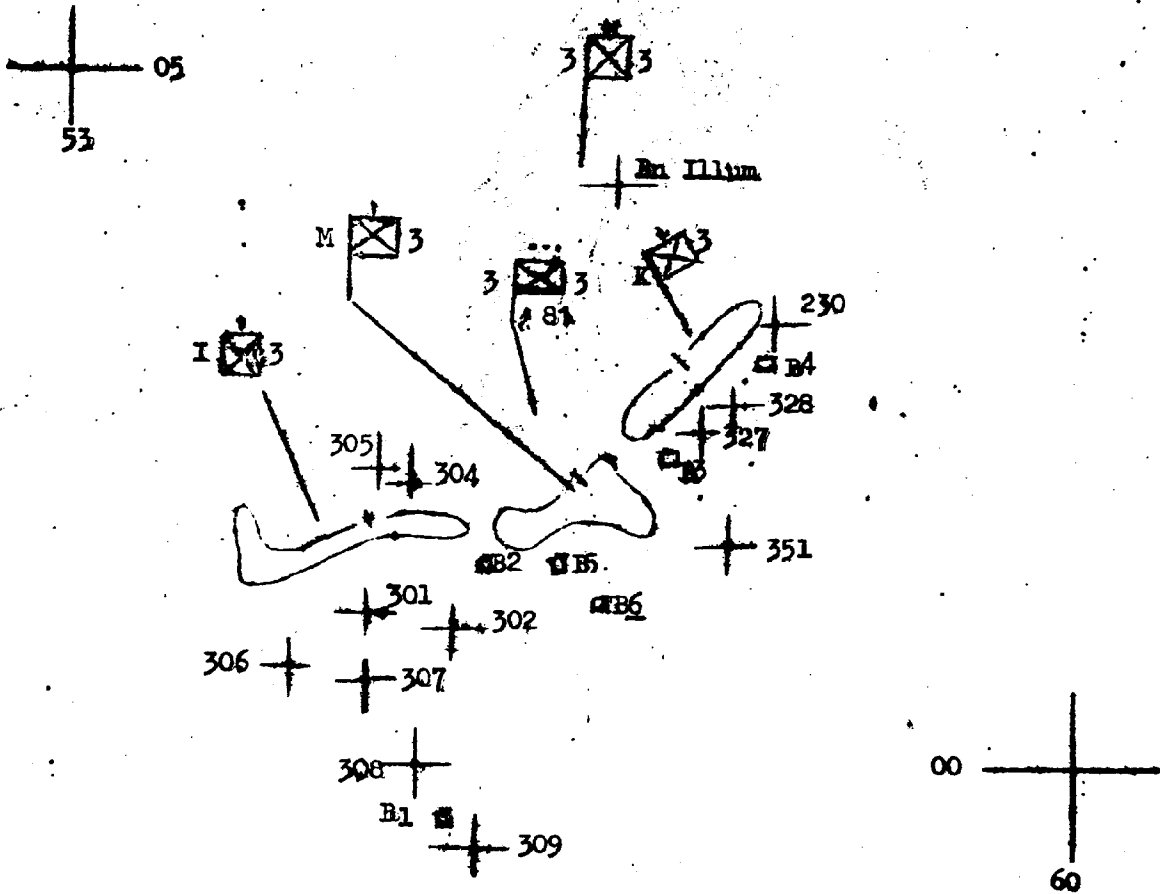

BY COMMAND OF LIEUTENANT COLONEL MUIR

*A. G. Comer*  
A. G. COMER

Major, U. S. Marine Corps  
Executive Officer

DISTRIBUTION: Special

3d (Rein) 3d Marines  
 Chu LAI, VIETNAM  
 031200H August 1965

3D BN, 3D MARINES

S&C #

Operation Order 10-65

COPY

057-65  
 33-OF-66-

Ref: (a) 4th Marines Operation Order 304-65

(b) Map: VIBENAM: 1:50,000, AMS Series L701, Sheets 6757II, 6757XII  
 6756I, 6756IV

Time Zone: H

Task Organization: Annex A (Task Organization).

### 1. SITUATION

a. Enemy Forces. Annex B (Intelligence)

b. Friendly Forces

- (1) 4th Marines (-) (Rein) continues to defend CHU LAI airfield and in conjunction with elements of the 51st Regiment, 2d ARVN Division will conduct combined search and destroy operations South of the TAOR.
- (2) 1st Marine Aircraft Wing provides CAS and helicopter support as required.
- (3) 3/51 ARVN conducts search and destroy operation in zone to left (North)
- (4) Artillery
  - (a) One Platoon, "K" Btry, 4th Bn, 12th Marines, direct support during D-Day and D+1.
  - (b) 107mm Howtar Btry and one (pl) 8" Howitzer direct support night of D-Day.
  - (c) 1st Plat, 8" Howitzer Btry FMF direct support on D+1.
- (5) ~~3d Plat., (Rein) Company "A", 3d Tank Bn., direct support. Prepares for commitment in 3/3 zone on order. Reinforced with flame section, blade tank, and retriever.~~

2. MISSION. 3d Bn, 3d Marines lands by helicopter in Landing Zone WOLF and conducts search and destroy operations in assigned zone.

### 3. EXECUTION

a. Concept of Operation. Annex C (Concept of Operation)

b. Company "I" (REIN)

- (1) Commencing L-Hour on D-Day land by helicopter in LZ WOLF.
- (2) Secure Landing Zone.
- (3) On order, attack eastward to seize and occupy left (East) half Battalion Objective A.
- (4) Search hamlet of TRA BINH (BS 532860) for Viet Cong personnel, equipment, weapons and supplies.
- (5) Be prepared to continue the attack to Battalion Objective B on order.

~~c. Company "I"~~

- ~~(1) Land in LZ WOLF in accordance with Appendix 1 (Sequence of Events) to Annex B (Concept of Operations) to Op Order 10-65.~~
- ~~(2) Seize and occupy high ground vicinity (BS 538865).~~
- ~~(3) Maintain visual contact with Company "I".~~
- ~~(4) Be prepared to continue the attack to seize that portion of Battalion Objective B in zone.~~

c. Company "M" (REIN)

- (1) Land in LZ WOLF in accordance with Appendix 1 (Sequence of Events), to Annex C (Concept of Operations) to Op Order 10-65.
- (2) Seize and occupy right (West) half of Battalion Objective A
- (3) Maintain visual contact with Company "I".
- (4) Be prepared to continue attack on order.

d. 81mm Mortar Plat., H&S Company

- (1) Land two (2) sections in LZ WOLF in accordance with Appendix 1 (Sequence of Events) to Annex C (Concept of Operations) to Op Order 10-65.
- (2) Occupy firing positions vicinity of LZ WOLF.
- (3) General Support
- (4) Be prepared to employ remainder of platoon for defense on night of D+1.

ef. Battalion Reserve, Company "K"

- (1) Land in LZ WOLF in accordance with Appendix 1 (Sequence of Events) to Annex C (Concept of Operations) to Operation Order 10-65.
- (2) Move to Battalion Objective A.
- (3) Provide security for Bn Command Group.
- (4) Be prepared for employment anywhere in Battalion Zone.

fg. Coordination Instructions

- (1) L-Hour to be announced.
- (2) D-Day ~~8~~ August 1965.
- (3) LOD is LOC
- (4) Contact center *LEFT TO RIGHT*
- (5) Companies will report crossing phase lines
- (6) Exercise caution for mines and booby traps.
- (7) Artillery and mortar smoke by authority of this Headquarters only.
- (8) Enemy will not be bypassed.
- (9) Spot reports on contact.
- (10) Annex D (Operations Overlay).
- (11) Annex F (Fire Support).
- (12) Annex G (Air Support)

4. ADMINISTRATION AND LOGISTICSa. Supplies

- (1) General. Unit commanders will obtain initial supplies as needed and directed. The S-L will be responsible for resupply on D-Day and D+1.
- (2) Supplies and Equipment available
  - (a) Class I. Each man will draw one (1) MCI prior to loading. This meal will be carried by the individual and consumed for the noon meal on D-Day. Helicopter resupply of MCI's will be made as scheduled in subparagraph (4) or on call.



- (b) Class II. Units will turn in shovels, picks and one axe per platoon to the Battalion Supply Officer prior to 1600 ~~4~~ August 1965. These will be delivered on position prior to darkness on D-Day.
- (c) Class III. Organic vehicles will not be taken.
- (d) Class IV. Fortification material will not be taken.
- (e) Class V. See Annex H (Ammunition Availability Table) to Op Order 10-65 for listing of ammunition availability.
- (f) Water. Each individual will ~~carry~~ two (2) full canteens. Water resupply, in five (5) gallon cans will be effected by helicopter as scheduled in subparagraph (4) or on call.

(3) Control and Distribution

(a) Class V

1. Each rifleman will carry one hundred (100) rounds of ammunition.
2. Each automatic rifleman will carry one hundred and forty (140) rounds of ammunition.
3. Each machine gun team will carry eight (8) belts of ammunition.
4. Each grenadier will carry twenty-five (25) M-79 rounds.
5. Each 3.5 rocket team will carry four (4) 3.5 rockets.
6. Grenades and other munitions will be carried at the direction of unit commanders.

b. Water Cans. All companies deliver fifty (50) water cans to the battalion S-4 prior to 1700 ~~4~~ August 1965.  
1600 5

(4) Resupply. Resupply is the responsibility of the S-4. All resupply will be by helicopter and requests must provide adequate lead time. Be specific as to time, coordinates and type and amounts of resupply required. Helicopter resupply is prescheduled as follows:

<u>DATE</u>	<u>TIME</u>	<u>COORDINATES</u>	<u>TYPE OF RESUPPLY</u>
05	1630	BS 573865	Ammunition as requested. One hundred twenty-five (125) full water cans, sufficient MCI's for three (3) meals per man. (to be used for evening meal on 6 Aug,



<u>DATE</u>	<u>TIME</u>	<u>COORDINATES</u>	<u>TYPE OF RESUPPLY</u>
			breakfast on 8 Aug and carried as the noon meal on 8 Aug) engineer tools, 81mm Mortars and ammunition. Comm wire as requested.
05	1800	BS 573865	Pick up empty water cans; deliver additional ammunition as requested.
06	0630	BS 573865	One hundred twenty-five (125) full water cans, pick up engineer tools, deliver ammunition as requested.
06	As Requested		As Requested

Additional helicopter resupply on call. The command group will direct a shift in prescheduled times and coordinates should the existing situation dictate such a change.

- (5) Captured Material. Captured material to be evacuated upon withdrawal. If evacuation is not possible, obtain all pertinent information and items of intelligence value and destroy the remainder.
  - (6) Salvage. All inoperative equipment will be salvaged and evacuated.
- b. Evacuation and Hospitalization. All casualties will be evacuated on foot, for evaluation by the battalion surgeon who will be in vicinity of the CP group. After evaluation, casualties will be further evacuated by helicopter as determined by the attending medical officer. All KIA's and less serious casualties will be evacuated by helicopter to the Battalion Aid Station for further processing and treatment. Serious casualties may be helicopter evacuated directly to "B" Medical Company at the discretion of the evaluating medical officer.
- c. Transportation. No organic transportation will be taken.
- d. Personnel
- (1) Strengths. Administrative and support personnel from all companies will remain in the battalion area.
  - (2) Prisoners of War. After processing by the Battalion S-2 section, all POW's will be forwarded to the Regimental Collection Point.
  - (3) Graves Registration.
    - (a) KIA's will be properly tagged by the unit corpsman, and evacuated to BAS as soon as it is operationally feasible.



- (b) Immediately after processing of a KIA by BAS, the cognizant administrative section will initiate action to close out the man's record book and conduct a thorough inventory of his personal effects. . .
- (c) KIA's will be evacuated to Company "B", 3d Medical Battalion, as soon as possible.
- (4) Civil Affairs - Military government. There will be no wanton destruction of public or personal property by any member of this organization.
- (5) Interior management. The absence of the Rifle Companies, and selected units from H&S Company, will necessitate a rearrangement of the CP defensive posture for the period of the operation. The rearrangement will be affected by the H&S Company commander prior to the commencement of the operation.
- e. Miscellaneous. *10 INDIVIDUALS TAKE 100MG TABLETS FOR WATER PURIFICATION*
- (1) Individual weapons and equipment of casualties will be tagged and evacuated with the casualty for recovery at the battalion aid station or Co. "B" 3d Medical Bn. in the case of those casualties not evacuated through the battalion aid station. Persons accompanying evacuees must take positive steps to ensure that weapons and equipment are tagged and recovered.
- (2) Normal arms and equipment with helmet, green side out. Body armor upper torso, optional according to individual choice.
- (3) Property NCO's of units participating will report to the S-4 in the loading zone prior to 0600H on D-Day. These NCO's will assist in the staging and loading of helicopter resupplies and will accompany supplies aboard helicopters to the landing zone where they will supervise and assist in the distribution of such supplies. These NCO's will return to the CP area by subsequent flights where they will continue to effect logistic liaison and exercise supervision and control over helicopter resupply missions for their respective units.
- (4) All personnel take two (2) salt tablets prior to L-Hour. Individual carry an additional ten (10) salt tablets.
- (5) Emphasize control of water cans.
- (6) Report by telephone upon return to the battalion area ammunition expended during the operation.
- (7) The battalion supply officer is the HST commander and will coordinate activities in the loading zone.

- (8) Prior to L-Hour on D-Day the S-1 will furnish the S-4 with strengths of participating units, to include PF and any attachments.
- (9) Unit commanders will insure that all personnel under their immediate command have the following items on their person prior to their departure from the battalion area:
- (a) a complete set of dog tags
  - (b) Geneva Convention Card
  - (c) Identification Card

5. COMMAND AND COMMUNICATION - ELECTRONICS.

- a. Guard radio nets commencing 050530H Aug 65.
- b. Command Posts
  - (1) Command Group initially airborne. When established ashore, CP vicinity (BS540854).
  - (2) Companies report CP locations as established.
- c. Axis of Communications. (BS 540854)(BS 548857) (BS563858) (BS 57086s).
- d. Pyrotechnics
  - (1) Ground to air see Annex G (Air Support) to Op Order 10-65.
  - (2) Red Star Cluster (1) encircled or attacked by the enemy.
  - (3) Red Star Cluster (Continuous fire of three (3) or more signals), request emergency illumination.
  - (4) Green Star Parachute, request ammunition.
  - (5) Green Star (hand held), request evacuation.
  - (6) Red Star Parachute,(hand held), we are withdrawing from this position.
  - (7) Green Smoke, inform us of enemy direction or position.
  - (8) Red Smoke, marking of enemy position.

*Joseph E. Muir*  
JOSEPH E. MUIR

Lieutenant Colonel, U. S. Marine Corps  
Commanding

ANNEXES

- A - Task Organization
- B - Intelligence
- C - Concept of Operation
- D - Operation Overlay
- E - Not Used.
- F - Fire Support
- G - Air Support
- H - Listing of Available of Class V

DISTRIBUTION: Special

3d Ba (Rein) 3d Marines  
 CEU LAI, VIETNAM  
 041800H August 1965

Change No. 1 to Operation Order 10-65

Ref: None

Time Zone: H

1. Make the following pen changes in Operation  
 Order 10-65

a. Basic Order.

- (1) Paragraph 1.b.(5). Delete .
- (2) Paragraph 3.b. title line. Add "(Rein)".
- (3) Paragraph 3.c. Delete.
- (4) Renumber subparagraphs. 3.d through 3.g. to read 3.c through 3f.
- (5) Paragraph 3.c title line. Add "(Rein)".
- (6) Paragraph 3.e title line. Delete "Company K".
- (7) Paragraph 3.f. (2). Change to read "D-day 6 August 1965".
- (8) Paragraph 3.f. (4). Change to read "Contact left to right".
- (9) Paragraph 4.a. (3)(b). Change "... 1700, 4 August ..." to read "... 1600, 5 August..."
- (10) Paragraph 4.a. (4). Substitute "6 August" for "5 August" and "7 August" for "6 August" whenever they appear in the sub-sub-paragraph.
- (11) Paragraph 4.e. Add "(10) Individuals take iodine tablets for water purification."

b. Annex F.

- (1) Page F-1, paragraph 3.b.(2). Delete.
- (2) Page F-1, paragraph 3.b. Renumber sub-subparagraph (3) and (4) to read (2) and (3).
- (3) Page F-1, paragraph 3.c. (3). Delete.
- (4) Page F-1, paragraph 3.c. Renumber sub-subparagraphs (4) and (5) to read (3) and (4).

[REDACTED]

c. Annex G.

(1) Page G-2, paragraph 2.1. (1). Change "(BS 523857)" to read "(BS 528857)."

2. Substitute the following new pages, attached hereto, for the original pages, destroying the replaced pages and reporting destruction to this headquarters:

- a. Annex A. Page A-1.
- b. Annex C. Page C-1.
- c. Annex C, Appendix 1. Page C-1-1.

BY COMMAND OF LIEUTENANT COLONEL MUIR

*A. G. Comer*

A. G. COMER  
Major, U. S. Marine Corps  
Executive Officer

DISTRIBUTION: Special

DECLASSIFIED

3d Bn (-) 3d Marines  
CHU LAI, VIETNAM  
041800H August 1965

Annex A (Task Organization) to Operation Order 10-65

Ref: None

Time Zone: H

All attachments effective 060600H August 1965

3d Bn (-) 3d Marines

LtCol MUIR

- Det., H&S Co. 3/3
- Det., Comm Plat., Hq Co., 4th Mar
- Artillery Ln Sec, Btry "C", 1st Bn, 12th Mar
- Det., Co "B" 3d Engr Bn
- Det., 3d Flat Co "B", 3d AT Bn

Company "I"

Capt. WEBB

- Co "I"
- FO Tm, 81mm Mortar Plat
- FO Tm, Btry "C" 1st Bn 12th Mar
- PLC Tm

Company "M"

Capt. MORRIS

- Co "M"
- FO Tm, 81mm Mortar Plat
- FO Tm, Btry "C" 1st Bn 12th Mar.

81mm Mortar Plat (-) H&S Co

Lt. GIBSON

Battalion Reserve

Lt. BEDNAR

BY COMMAND OF LIEUTENANT COLONEL MUIR

A. G. COMER  
Major, U. S. Marine Corps  
Executive Officer

DISTRIBUTION: Special

OFFICIAL:

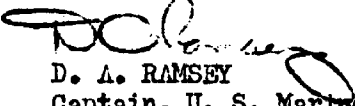
  
D. A. RAMSEY  
Captain, U. S. Marine Corps  
S-3

A-1

DECLASSIFIED

3d Bn (Rein) 3d Marines  
 CHU LAI, VIETNAM  
 030900H August 1965

Annex B (Intelligence ) to Operation Order 10-65

Ref: (a) Maps: VIETNAM, 1:50,000 AMS Series L701, Sheets 6757 II, 6757 III, 6756 I and 6756 IV.

Time Zone: H

1. SUMMARY OF ENEMY SITUATION

- a. See enemy situation overlay.
- b. See current Isums and Summaries as issued.

2. ESSENTIAL ELEMENTS OF INFORMATION

- a. Determine if VC opposition will be encountered during or subsequent to the landing, if so, in what strength?
- b. Do VC forces occupy high ground coord BS 516856 or coord BS 540855 so as to obstruct the landing, and if so, will they defend these areas?
- c. Will the VC be reinforced, if so, when, where, in what strength and by what means?
- d. Determine the identity, strength, composition and disposition of enemy forces located in area of operations. Particular attention to mortar and artillery units.
- e. Determine VC sources of support, supply and routes of infiltration.
- f. Determine if local civilian population will support our forces actively or be passive in their reaction while supporting the VC by covert means.

3. RECONNAISSANCE AND OBSERVATION MISSIONS

a. Orders to subordinate units

(1) All Companies

- (a) Be prepared to conduct reconnaissance missions as directed.
- (b) Particular attention to southern flank of battalion zone of action.

b. Requests to higher, adjacent and supporting units

(1) 4th Marines

- (a) Provide information on enemy strength, disposition, and capabilities.
- (b) Provide current information on enemy disposition after operation commences.

c. Coordinating Instructions

- (1) Companies will notify this Headquarters (S-2) of evacuation of all VC/VCS, captured documents and materials including weapons, and any other pertinent intelligence information.
- (2) All evacuation will be through the Battalion Command Post, either forward or rear.

4. INTELLIGENCE SUPPORT REQUIREMENTS

a. Request following assistance be provided or arranged for by the 4th Marines.

- (1). Composition of villages within area of operation to include village leaders and/or significant personalities.
- (2) Provide minimum of two English speaking ARVN interpreters to assist with matters pertaining to intelligence and security.

5. MEASURES FOR HANDLING PRISONERS, CAPTURED DOCUMENTS AND CAPTURED MATERIALS

a. Prisoners

- (1) All VCS will be interrogated by Detachment CI Team at the Battalion Collection Point at coordinates BT 568043 as soon as possible after capture.
- (2) All VCS will be tagged with the standard POW/Equipment Tag. Tags will be filled out as completely as possible.
- (3) Companies will interrogate prisoners for information of immediate tactical information only.



AL

b. CAPTURED DOCUMENTS

- (1) All captured documents will be tagged with, time, coordinates where found, capturing unit, and description.
- (2) Documents will be evacuated with prisoners and turned over to POW guards at the Battalion Collection Point as soon after capture as possible.

c. CAPTURED MATERIAL

- (1) All material, except documents and weapons, found on VC and VCS will be left on the individual until he is delivered to the Battalion Collection Point.
- (2) All weapons will be removed from prisoners by the capturing unit, tagged with completed tags, and turned in to Battalion Collection Point as soon after capture as possible.

6. MAPS AND PHOTOGRAPHS

- a. In accordance with BnO 3800.1C.
- b. Reference (a) is designated as the standard tactical map, employing the UTM grid system.

7. REPORTS AND DISTRIBUTION

- a. See section VIII of BnO 3800.1C.

BY COMMAND OF LIEUTENANT COLONEL-MUIR

A. G. COMER  
Major, U. S. Marine Corps  
Executive Officer

APPENDIX:

1 - Enemy Situation Overlay

DISTRIBUTION: Special

OFFICIAL:

D. W. STUMP

First Lieutenant, U. S. Marine Corps

S-2

B-3

3d Bn (Rein) 3d Marines  
CHU LAM, VIETNAM  
030900H August 1965

Appendix 1 (Enemy Situation Overlay) to Annex B (Intelligence) to  
Operation Order 10-65

Ref: (a) Maps: VIETNAM, 1:50,000 AMS Series 1701, Sheets 6757 II,  
6757 III, 6756 I and 6756 IV.

Time Zone: H

1. ENEMY SITUATION OVERLAY

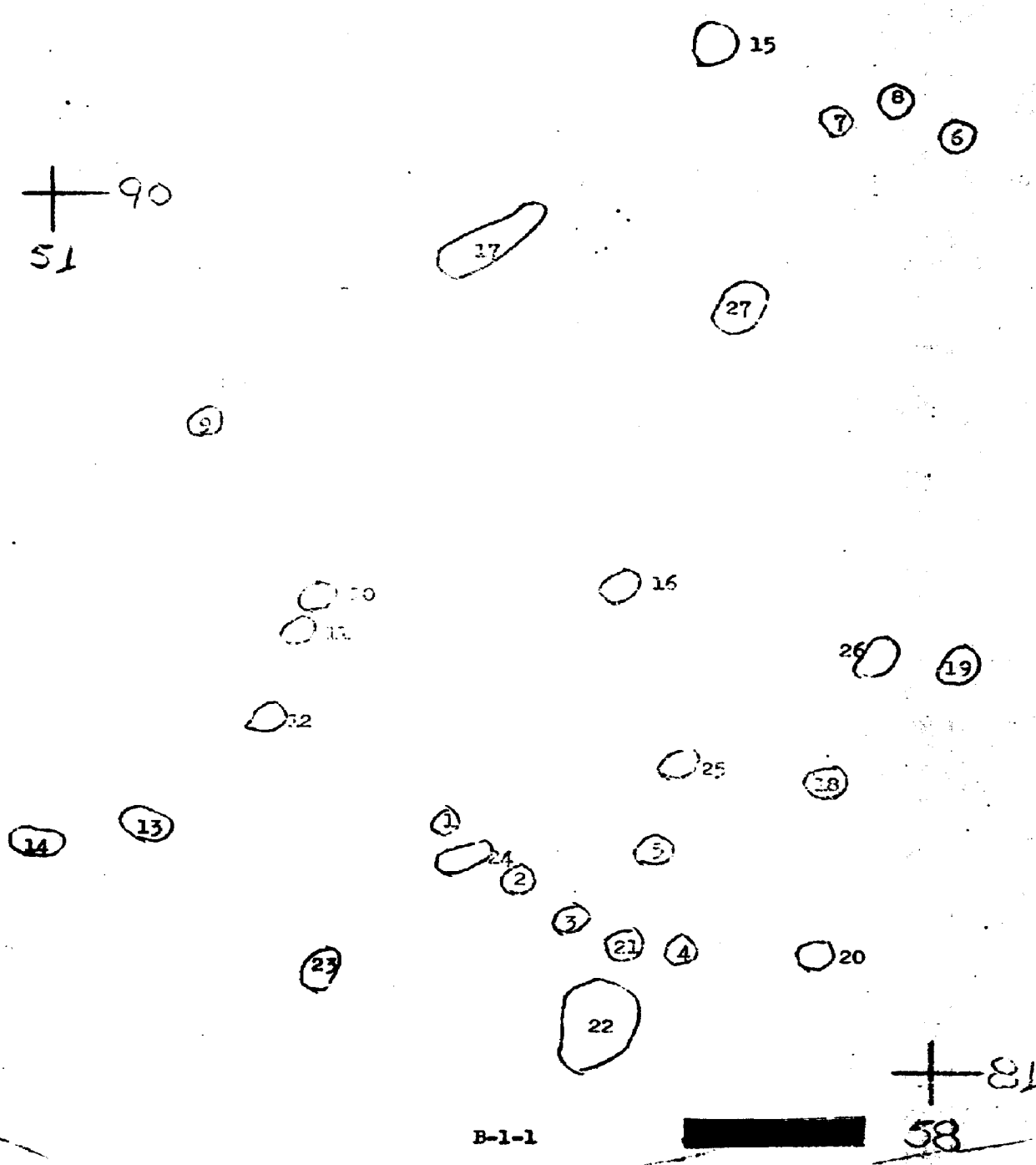

B-1-1

- 
1. 80 foxholes on sides of road; L-Shaped trench line 1400 feet long south side of road.
  2. Possible AW position on hill top.
  3. Trench line
  4. 60 foot trench line
  5. 60 foxholes
  6. possible AW positions (9) along north side of road.
  7. 3 possitive AW positions
  8. Underground bunkers.
  9. Trench line AW position on east end
  10. AW position
  11. 2 buildings surrounded by ditch 8 feet wide
  12. Fortified village centered at BS 528847
  13. 28 Foxholes
  14. 32 Foxholes along sides of road
  15. Fortified village centered at BS 565914
  16. Helicopter landing area marked with H.
  17. Extensive trench lines
  18. Fortified village centered at BS 574839
  19. L-Shaped trench line
  20. Fortified village centered at BS 574822
  21. Possible OP at BS 557823
  22. Strong Point centered at BS 555815, AW positions, 4 Mortar positions, ammo pit, 19 foxholes along side of road. ARVN type camp centered at BS 554817 with 32 foxholes from BS 554818 to BS 522820 along both sides of road.

[REDACTED]

- 23. 25 Foxholes surrounding U/I building 28 feet by 16 feet.
- 24. Trench line centered at BS 544833.
- 25. Two possible AW positions.
- 26. Trench line 925 feet long running NE-SW.
- 27. Possible U/O AA position at BS 568888.

BY COMMAND OF LIEUTENANT COLONEL MUIR

A. G. COMER  
Major, U. S. Marine Corps  
Executive Officer

DISTRIBUTION: Special

OFFICIAL:

*D. W. Stump*  
D. W. STUMP

First Lieutenant, U. S. Marine Corps

S-2

B-1-3

[REDACTED]

DECLASSIFIED

3d Bn (Rein) 3d Marines  
CHU LAI, VIETNAM  
041800 August 1965

Annex C (Concept of Operation) to Operation Order 10-65

Ref: (a) Map: VIETNAM: 1:50,000, AMS Series L701, Sheets 6757II, 6757III,  
6756I, 6756IV

Time Zone: H

1. Mission. See Basic Order.
2. Concept
  - a. Commencing at L - hour on D - day, 3/3 lands in three increments in IZ WOLF.
  - b. The first increment will secure the landing zone in order to facilitate the rapid entry of the remainder of the battalion.
  - c. The second increment will land, proceed along a direction of attack and seize the right (West) portion of Battalion Obj. A.
  - d. The third increment will land and proceed along a direction of attack to the high ground vicinity (BS 538865).
  - e. Upon completion of the landing the first increment will proceed on an axis of advance through the hamlet of TRA BINH and seize the left (East) portion of Battalion Obj. A.
  - f. After seizure of Battalion Objective A the battalion will continue the attack on three parallel axes. One company on the left (North), one company on the right (South), and the Battalion Command Group in the center.
  - g. Annex D (Operation Overlay).

BY COMMAND OF LIEUTENANT COLONEL MUIR

A. G. COMER  
Major, U. S. Marine Corps  
Executive Officer

DISTRIBUTION: Special

OFFICIAL:

  
D. A. RAMSEY  
Captain, U. S. Marine Corps  
S-3

C-1

DECLASSIFIED

Bn, 3d Marines  
 U LMI, VIETNAM  
 041800H August 1965

Appendix 1 (Sequence of Events) to Annex C (Concept of Operations) to Operation Order 10-65

Ref: None

Time Zone: H

1. The below listed events will occur in the sequence indicated on D-Day:

L - 2½ Hours	Reveille
L - 2 Hours	Guard all radio nets
L - 1 Hour	Assemble Vicinity LZ LOON
L - 1 Hour	Loading zone prepared to load
L - 15 Min	Load First Increment
L - 15 Min	Air Preparation of LZ
L - Hour	First Increment lands in LZ WOLF and secures LZ
L - Hour	Air Strike Vicinity (BS 536854) to (BS 545855)
L + 15 Min	Second Increment and Battalion Cmd Gp Load from LZ LOON
L + 30 Min	Second Increment and Battalion Cmd Gp land in LZ WOLF
L + 45 Min	Third Increment loads from LZ LOON
L + 1 Hour	Third Increment lands in LZ WOLF

2. L - Hour in this order is touch-down of leading elements of 3/3 in Landing Zone WOLF.

BY COMMAND OF LIEUTENANT COLONEL MUIR

A. G. COMER  
 Major, U. S. Marine Corps  
 Executive Officer

DISTRIBUTION: Special

OFFICIAL:

  
 D. A. RAMSEY  
 Captain, U. S. Marine Corps  
 S-3

C-1-1

3d Bn (Rein) 5d Marines

CEM. [REDACTED]

031207E [REDACTED] 1965

Operation Order 10-65

Scale: 1:50,000, AMS Series 1701, Sheets 6757II, 6757III, 6756I, 6756II

Time Zone: +8

MARK

52  
+  
92

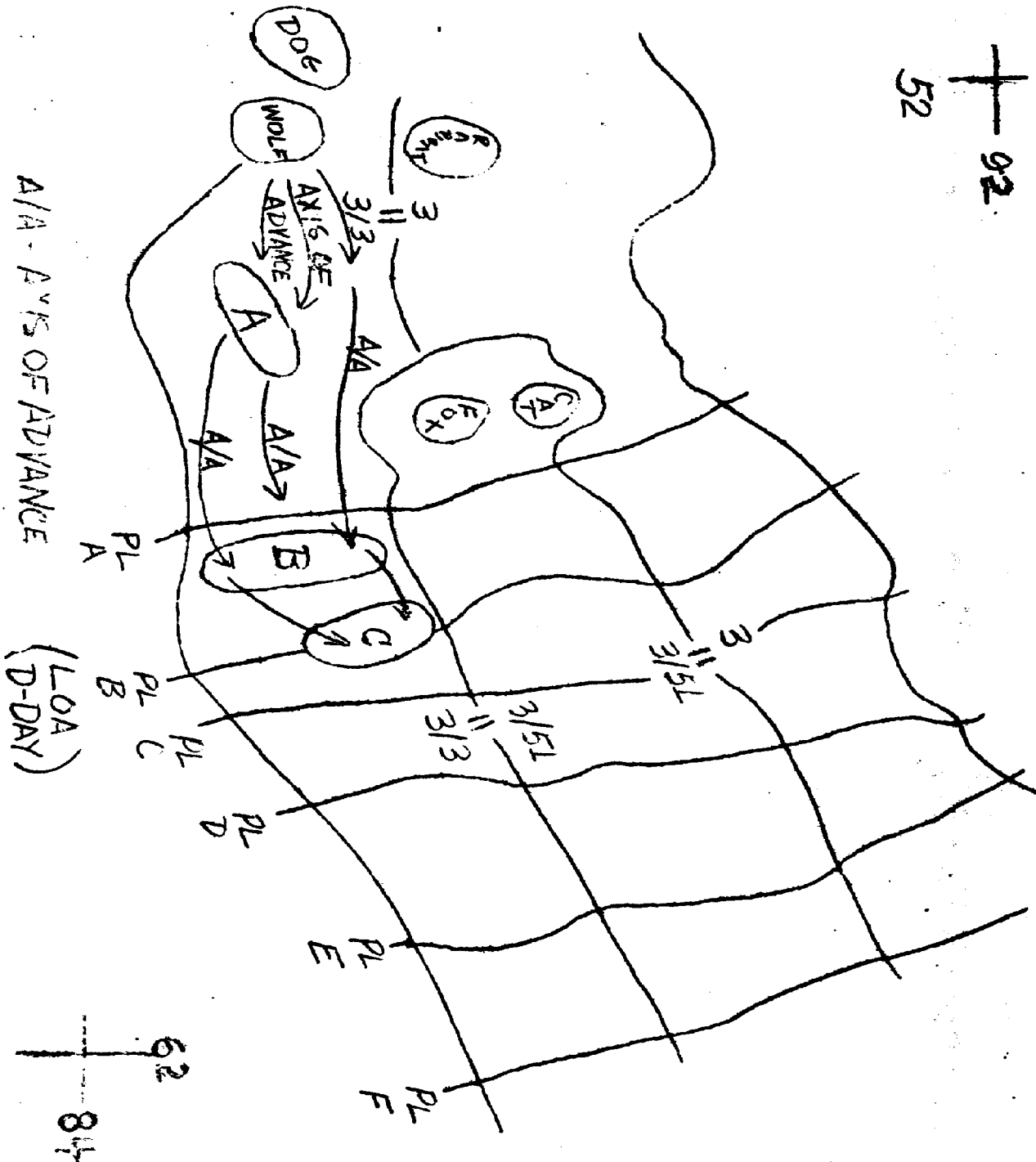

BY COMMAND OF LIEUTENANT COLONEL [REDACTED]

A. G. COMER  
Major, U. S. Marine Corps  
Executive Officer

D-1

3d Bn, 4th Bn, 12th Marines  
 Chu Lai, Vietnam  
 031200H August 1965

Annex F (Fire Support Plan) to Operation Order 10-65

Ref: Map: VIETNAM: 1:50,000 AMS L701 Sheets 6756I, 6756IV, 6757II, 6757III

Time Zone: H

1. SITUATION. See basic order.
2. MISSION. 3d Bn (-) (Rein)-3d Marines conducts search and destroy operation south of the SONG TRA BONG.
3. EXECUTION.
  - a. 81mm Mortar Platoon
    - (1) General Support
    - (2) Land two (2) sections in LZ WOLF and move with CP Group providing on call fire support to rifle companies.
    - (3) Carry sufficient rounds to support operation for D-Day. Resupply by helicopter on evening of D-Day.
    - (4) Embark remaining mortars and personnel with evening resupply on D-Day.
  - b. One Plat. Btry "K", 4th Bn, 12th Marines
    - (1) Occupies forward firing positions prior to L-Hour on D-Day and provides direct support to 3d Bn 3d Marines.
    - (2) ~~Prepares LZ WOLF with Shell HE Fuse VT from L-15 to L-Hour.~~
    - (3) Return to position behind MLR, on order, the evening of D-Day and reoccupy a forward firing position to continue in direct support of 3d Bn, 3d Marines on the morning of D+1.
    - (4) Pre-Planned concentration for on-call fires (Appendix 1).
  - c. 1st 8" Howitzer Plat., 1st 8" Howitzer Btry, FMFPAC
    - (1) General Support
    - (2) Occupies forward firing positions with "K" Btry 4th Bn 12th Mar. on D-Day and provides fire support for Operation Order 10-65.
    - (3) ~~Prepare LZ WOLF with Shell HE Fuse VT from L-15 to L-Hour~~





<sup>3</sup>  
(4) Continues fire support from forward firing position until D+1, on order return to position behind MLR.

<sup>4</sup>  
(5) Pre-Planned concentrations for on call fires (Appendix 1)

d. 107mm Howtar Btry, 3d Bn., 12th Marines

- (1) Lands in designated LZ on evening of D-Day.
- (2) Provides direct support to 3d Bn 3d Marines on evening of D-Day.
- (3) On order the morning of D+1, Btry helilifted out of designated LZ and back to position within MLR.

e. Coordination of supporting arms through 4th Marines FSCC.

4. COMMAND AND COMMUNICATIONS

a. FSCC will move with CP group.

b. Communications. Artillery conduct of fire

BY COMMAND OF LIEUTENANT COLONEL MUIR

A. G. COMER  
Major, U. S. Marine Corps  
Executive Officer

APPENDIX

1 - On Call Fires

DISTRIBUTION: Special

OFFICIAL

*D. A. Ramsey*  
D. A. RAMSEY

Captain, U. S. Marine Corps

S-3





3d Bn (Rein) 3d Marines  
 CHU LAI, VIETNAM  
 031200H August 1965

Appendix 1 (On Call Fires) (Arty) to Annex F (Fire Support) to Operation Order 10-65

Ref: (a) Map; VIETNAM, 1:50,000 AMS Series L701, Sheets 6757II, 6757III, 6756I, 6756F

Time Zone: H

<u>CONCENTRATION #</u>	<u>COORDINATES</u>	<u>TARGET</u>
CC 800	538865	Hill
CC 801	549861	Possible Ambush Area
CC 802	553847	Hill
CC 803	559850	Trail
CC 804	569845	Critical Terrain
CC 805	569854	Critical Terrain
CC 806	578858	Critical Terrain
CC 807	562858	Critical Terrain
CC 808	568861	Critical Terrain
CC 809	568865	Critical Terrain
CC 810	573868	Critical Terrain
CC 811	548856	Critical Terrain
CC 812	540855	Possible Ambush Area
CC 813	552836	Critical Terrain

BY COMMAND OF LIEUTENANT COLONEL MUJR

A. G. COMER  
 Major, U. S. Marine Corps  
 Executive Officer

DISTRIBUTION: Special

OFFICIAL

*D. A. Ramsey*  
 D. A. RAMSEY

Captain, U. S. Marine Corps

S-3

F-1-1



B. Rein) 3d Marines  
 CHU LAI, VIETNAM  
 031200H August 1965

Annex G (Air Support) to Operation Order 10-65

Ref: Map: VIETNAM: 1:50,000, AMS L701, Sheets 6756I, 6756IV, 6757II, 6 757III

Time Zone: H

1. SITUATION

a. Enemy Forces. See Annex B (Intelligence )

b. Friendly Forces

- (1) Escort Aircraft, close air support, and helicopters will be furnished by 1st Marine Aircraft Wing as required.
- (2) Coordination of all aircraft in area of operations will be by 4th Marines Headquarters.

2. PROCEDURES

a. Coordination of Supporting Fires. See ref (a) and Annex F

b. Universal Transverse Mercator (UTM) Grid Reference System will be used for target location.

c. Alert Status of Aircraft. All close air support aircraft will be on thirty (30) minute standby due to condition of SATS at CHU LAI.

d. Ordnance

- (1) Bombs - M81, 250lbs; M82, 500lbs; M83, 750lbs; and napalm.
- (2) Rockets - Aero 7D 19 Shot Packs, 2.75"
- (3) Other - 20mm Cannon

e. Helo Escort

- (1) Helo escort will be utilized during landing of troops in LZ FOX, WOLF, and BEAR.
- (2) Helo escort will be utilized during retraction operations on D+1

f. Suppressive Fires. Suppressive fires will be conducted by escort aircraft, with the first wave into each LZ.

g. Close Air Support will be on station from L-Hour to L+2.

h. Marking of Friendly Positions. Display panels or mark with yellow smoke closest friendly unit prior to execution of close air strikes.

**h. Helicopter Landing Zone Preparation.**

- (1) Prior to L-Hour in each helicopter landing zone the zone will be preped utilizing support aircraft.
- (2) Thirty (30) minutes after LZ WOLF is preped hill mass at (BS 538854) will be preped.

**j. Fast Reaction Force.** At completion of the helilift of 3d Bn 3d Marines and the ARVN Forces, helicopters will be available for lift of reserve forces into designated LZ.

**k. Airborne Observer.** There will be a battalion observer and radio relay aircraft DOG-B on station during daylight hours. Two (2) radio operators will be furnished from the communication platoon as part of the flight crews.

**2. Helicopter Landing Zones**

1. Primary. WOLF 3d Bn 3d Marines (US) (BS 528857)
2. Alternate. DOG 3d Bn 3d Marines (US) (BS 512862)

**n. Helicopter Pickup Zone.** 3d Bn 3d Marines (BT 512862)

**o. Emergency Evacuation.** Request for emergency helicopter will be submitted to the Air Liaison Officer, 4th Marines, by the most expeditious means available and will include the following information:

- (1) Number of personnel to be evacuated
- (2) Nature of injury
- (3) Pickup coordinates and how zone will be marked
- (4) LZ secured or not secured commensurate with the situation.

**o. Casualties.** All minor casualties of 3d Bn 3d Marines will be taken to the Battalion Aid Station 3d Bn 3d Marines. All serious casualties of 3d Bn 3d Marines will be taken to Company "B" 3d Medical Bn. The color RED on the casualty tag will designate casualties to be transported to Co "B" 3d Medical Bn. BLACK on casualty tag will designate casualties for BAS 3d Bn 3d Marines. The BAS LZ is BCBAT - A.

**p. Command Helicopter.** A command helicopter will be located at the 4th Marines command post (coordinates to be announced) during daylight hours.

**q. Resupply.** All resupply requests by helicopter will be submitted to the battalion S-4 who will in turn submit helo requests to the ALO.



Request will include:

- (1) Load to include description , weight, and cube.
- (2) Pickup coordinates ( probably BOBCAT), date time group resupply is desired and destination coordinates.
- (3) How LZ will be marked.
- (4) Whether or not unit being resupplied will be up on LZ control frequency.

3. COMMAND AND COMMUNICATION - ELECTRONICS

- a. All 3d Bn 3d Marines nets will be manned on appropriate frequencies.
- b. Location of Control Agencies
  - (1) All Bn control agencies will be foot mobile with the Bn Command Group.
  - (2) 4th Marines control agencies will be located with the 4th Marines Forward Command Group.

BY COMMAND OF LIEUTENANT COLONEL MUIR

A. G. COMER  
Major, U. S. Marine Corps  
Executive Officer

DISTRIBUTION: Special

OFFICIAL:

  
D. A. RAMSEY

Captain, U. S. Marine Corps

S-3



3rd Bn (Rein) 3rd Marines  
 CHU LAI, VIETNAM  
 031000H August 1965

Annex H - (Listing of Available Class V) to accompany Operation  
 Order 10-65

Time Zone: H

1. The ammunition listed below is available for distribution.

<u>DOD</u>	<u>NOMENCLATURE</u>	<u>NO. ROUNDS</u>
A 124	7.62 tracer	2,880
A 127	7.62 linked	50,400
A 130	7.62 5rd clip	113,400
A 182	Cal..30 carbine	4,700
A 209	Cal..30 linked M-1	6,250
A 475	Cal..50 spotter tracer	728
A 574	Cal..50 linked	2,000
B 568	HE 40mm M407	730
C 222	81mm HE M362	204
C 225	81mm HE M43A1	370
C 226	81mm Illum	138
C 230	81mm smk WP	161
C 650	106 RR HEAT	60
C 651	106 RR HEP-T	64
G 800	Adapter gren proj.	96
G 839	7.62mm otg. rifle gren	516
G 890	Gren hand Frag	357
G 895	Gren hand illum	62
G 900	Gren hand incendiary	32
G 935	Gren hand smk WP	109
G 940	Gren hand smk Green	49
G 950	Gren hand smk Red	110
G 970	Gren rifle HEAT	40
H 030	Gren rifle smk WP	50
H 600	3.5 HEAT	63
H 602	3.5 smk WP	43
K 134	Claymore mine M18A1	167

H-1

DECLASSIFIED



<u>DCD</u>	<u>NOMENCLATURE</u>	<u>NO. QUANTITY</u>
K 910	Thickener incendiary oil (5 1/2 lb)	18 cans
L 275	Signal smk illum (hand held) AN	120
L 311	Signal illum Red star para	102
L 324	Signal illum Green star para	27
L 314	Signal illum green star cluster	144
L 315	Signal illum Red star para	140
L 326	Rifle-green Red Star para	27
L 495	Trip flare M49	30
M 026	Demo kit bangalore	1 cs
M 032	Charge demo TNT 1-lb	50 lbs
M 130	Cap blasting electric	383
M 131	Cap non-electric blasting	230
M 455	Det cord	1,500 ft.
M 680	Ignition cyl flamethrower	200 ea
M 766	Igniter blasting fuse	200 ea
M 756	Charge assembly demo kit M37	46 ea

BY COMMAND OF LIEUTENANT COLONEL MUIR

A. G. COMER  
Major, U.S. Marine Corps  
Executive Officer

DISTRIBUTION: Special

OFFICIAL:

*D.A. Ramsey*

D. A. RAMSEY

Captain, U. S. Marine Corps

S-3

H-2

  
CONFIDENTIAL

3d Bn (Rein) 3d Marines  
 CHU LAI, VIETNAM  
 051400H August 1965

Operation Plan 11-65

Ref: (a) 4th Marines Frag Order #10  
 (b) Map: VIETNAM; AMA L701, Sheets 6757III, 6757II

Time Zone: H

L. SITUATION

- a. Enemy Forces. Current INTSUMS
- b. Friendly Forces
  - (1) 4th Marines continues missions assigned by reference (a).
  - (2) 2d Bn. 4th Marines operates to the right (West) flank of 3d Bn 3d Marines sector.
  - (3) Det. 1st Force Recon Co. direct support. Provides terminal guidance for helicopter.
  - (4) 1st Marine Aircraft Wing provides CAS and helicopter support as required.
  - (5) 3d Bn 12th Marines general support 4th Marines.
- c. Attachments and Detachments. No change.
- d. Assumptions
  - (1) That helicopter support will be provided as required.
  - (2) That a detachment from the 1st Force Reconnaissance Company will be available to provide support as required.

2. MISSION. 3d Bn 3d Marines lands one company by helicopter on TRUNG PHAN Peninsula, establishes night ambushes and conducts search and destroy operations.

3. EXECUTION

- a. Concept of Operation
  - (1) 3d Bn 3d Marines lands one (1) company at H-Hour on D-Day in LZ to be designated; establishes platoon size ambushes vicinity (BS 629992) and (BS 630985). On order conducts search and destroy operations to (BT 621005) where this company will be relieved by a second company that will continue the operation through SON TRA (1) (BT 6201).
  - (2) Each company will be retracted by LVT upon completion of its phase of the operation.



(3) Annex A (Operations Overlay).

b. Company "I"

- (1) Commencing at H-Hour on D-Day land in LZ to be designated on TRUNG PHAN Peninsula .
- (2) Establish platoon size ambushes vicinity (BS 629992) and (BS 630985).
- (3) On order, conduct search and destroy operation to vicinity (BT 621005).
- (4) Effect juncture with Company "M" and upon relief return to MLR by LVT.

c. Company "K". Regimental Reserve.

d. Company "L"

- (1) Continue defense of MLR in assigned sector.
- (2) On order occupy OP #1 (BS 599997) and Company "I" sector of MLR.
- (3) Be prepared to occupy Company "M" sector of MLR on order.

e. Company "M"

- (1) On order, embark in LVT's and relieve Company "I" vicinity (BT 621005).
- (2) Conduct search and destroy operation through SON TRA (1) (BT 6201).
- (3) Upon completion of operation return to MLR by LVT.

f. Coordinating Instructions

- (1) H-Hour 0130H
- (2) D-Day tentatively 11 August 1965.
- (3) Retraction beaches to be designated.
- (4) Landing Zone to be designated.
- (5) Emphasize stealth during night movement.
- (6) All armed indigenes, except assigned PF, will be considered VC
- (7) Civilian curfew between 2000 and 0600.



- (8) Maximum effort will be exercised to prevent injury to innocent civilians or their property.
- (9) Supporting arms on request to FSCC.
- (10) Helicopter rehearsal 102030H August 1965.
- (11) Annex A (Operations Overlay).
- (12) Annex B (Landing Plan).

4. ADMINISTRATION AND LOGISTICS

a. Supply

- (1) B/A Class V
- (2) Two (2) canteens of water and one (1) MCI per man.
- (3) No resupply.

b. Evacuation and Hospitalization. Normal

5. COMMAND AND COMMUNICATIONS - ELECTRONICS

a. Normal communications and pyrotechnics.

b. Command Posts

- (1) Bn CP remains present location (BT 565043). In event of marginal communications, displaces by LVT(C) to (BT 617017).
- (2) Report CP locations when established.

*J. E. Muir*

J. E. MUIR  
Lieutenant Colonel, U. S. Marine Corps  
Commanding

ANNEXES

- A - Operation Overlay (To be issued)
- B - Landing Plan (To be issued)

DISTRIBUTION: Special



3d Bn (Rein) 3d Marines  
 CHU LAI, VIETNAM  
 112200H August 1965

Operation Plan 12-65

Ref: (a) 4th Marines Frag Order #10  
 (b) Map: VIETNAM; AMS L701, Sheets 6757III, 6757II

Time Zone: H

1. SITUATION

a. Enemy Forces. Current INTSUMS

b. Friendly Forces

- (1) 4th Marines continues missions assigned by reference (a).
- (2) 2d Bn 4th Marines operates to the west (right) flank of 3d Bn 3d Marines sector.
- (3) 1st Marine Aircraft Wing provides CAS and helicopter support as required.
- (4) 3d Bn 12th Marines, general support 4th Marines.

c. Attachments and Detachments. No change

d. Assumptions

- (1) That helicopter support will be provided as required.

2. MISSION. 3d Bn 3d Marines lands one company by helicopter on TRUNG PHAN Peninsula, conducts search and destroy operation and establishes night ambushes.

3. EXECUTION

a. Concept of Operation

- (1) 3d Bn 3d Marines lands one (1) company at H-hour on D-day in designated LZ (BT 664996); conducts search and destroy operations in area assigned, establishes platoon size ambushes vicinity

(BS 670950) and (BS 653950) and moves to (BS 678973) from where the company will be retracted by helicopters upon completion of the operation.

- (2) Annex A (Operations Overlay)
- b. Company "I"
- (1) Continue defense of MLR in assigned sector.
  - (2) Continue to occupy OP #1 (BS 559997) and a traffic control point along National Route #1
- c. Company "K" Regimental Reserve
- d. Company "M"
- (1) Continue defense of MLR in assigned sector
  - (2) On order occupy OP #3 and Company "M" sector of MLR.
- e. Company "M" (Rein)
- (1) Commencing at H-hour on D-day land by helicopter at (BT 666996) on TRUNG PHAN Peninsula.
  - (2) Conduct search and destroy operations. Use Annex A (Operations Overlay).
  - (3) Establish platoon size ambushes vicinity (BS 670950) and (BS 653950).
  - (4) At 151200H move to (BS 678973) for return by helicopter to the MLR.
  - (5) M/C Team attached
- f. Coordinating Instructions
- (1) H-hour 0730H
  - (2) D-day tentatively 14 August 1965
  - (3) Attachments and detachments will be effective 140700H Aug 1965
  - (4) All armed indigenous personnel except PT's will be considered VC
  - (5) Civilian curfew between 2000 and daylight
  - (6) Maximum effort will be exercised to prevent injury to innocent civilians or their property.
  - (7) Supporting Arms on request to FSCC
  - (8) Helicopter briefing 131500H August 1965

[REDACTED]

(9) Annex A (Operations Overlay).

4. ADMINISTRATION AND LOGISTICS

a. Supply

- (1) B/A Class V
- (2) Two (2) canteens of water and one (1) MCI per man.
- (3) Contact S-4 for resupply.

5. COMMAND AND COMMUNICATIONS - ELECTRONICS

a. Normal communications and pyrotechnics.

b. Command Posts

- (1) Bn CP remains present location (BT 565043). In event of marginal communications, displaces by LVT (C) to (BT 617017).
- (2) Report CP locations when established.

*J. E. Muir*

J. E. MUIR  
Lieutenant Colonel, U. S. Marine Corps  
Commanding

DISTRIBUTION: Special

3d Bn (Rein) 3d Marines  
CHU LAI, VIETNAM  
112200H August 1965

Annex A (Operations Overlay) to Operation Plan 12-65

Ref: Map: VIETNAM, AMS L701 Sheets 6757III, 6757II

Time Zone: H

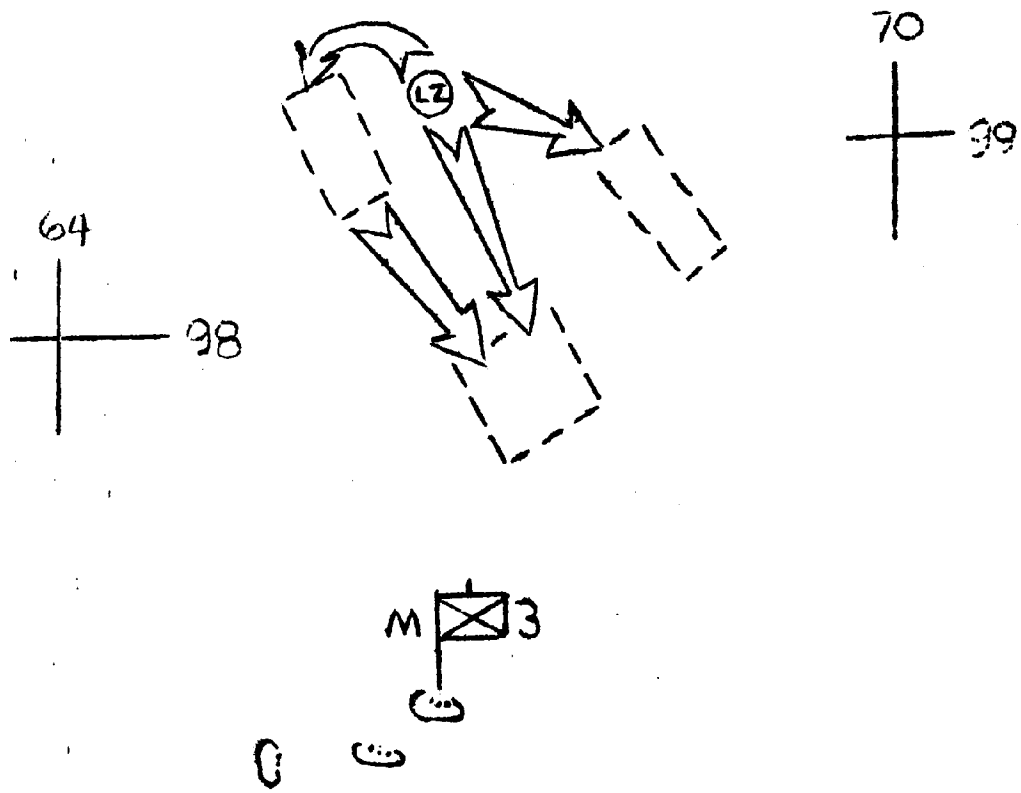

BY COMMAND OF LIEUTENANT COLONEL MUIR

A. G. COMER  
Major, U.S. Marine Corps  
Executive Officer

DISTRIBUTION: Special

OFFICIAL

*[Signature]*  
D. A. RAMSEY  
Captain, U. S. Marine Corps  
S-3

A-1

3d Bn (rein) 3d Marines  
 CHU LAI, VIETNAM  
 131400H August 1965

Operation Plan 13-65

Ref: (a) Map: VIETNAM, 1:50,000 Series L701, Sheets 6757II, 6757III

Time Zone: H

Task Organization: See annex A (Task Organization)

### 1. SITUATION

a. Enemy Forces: See annex B (Intelligence)

b. Friendly Forces

- (1) 4th Marines continue to defend CHU LAI airfield and auxiliary facilities.
- (3) First Marine Aircraft Wing provides CAS and helicopter support as required.
- (4) 3d Bn, 12th Marines, general support 4th Marines, priority of fire one 105mm Howitzer Btry to 3/3.
- (5) 3d Plat, Co "A", 1st Atrac Bn direct support.
- (6) 3d Plat, Co "A", 3d Tank Bn, direct support.
- (7) 3d Plat, Co "B", 3d AF Bn, direct support.
- (8) 3d Plat, Co "B", 3d Engr Bn, direct support.
- (9) Det, Naval Beach Group 1 provides boats as available for interdiction of coastline.

2. Mission. Commencing a-hour on D-day, 3d Bn, 3d Marines lands by helicopter in LZ [redacted] and [redacted], conducts search and destroy operation in assigned area, and returns to battalion area on order.

### 3. Execution

a. Concept of Operation

#### 1. Phase 1 (D-day)

- (a) Land two (2) companies in LZ [redacted] and one company in LZ [redacted].
- (b) Search generally to the North in zone to phase line Yo-Yo.

(c) Consolidate positions along Phase Line YO-YO on night of D-day.

(d) Establish night ambushes and patrols throughout area.

2. Phase II (D+1)

(a) Search generally to the North in zone to water line of the VUNG DUNG QUAT.

(b) Retract two (2) companies by helicopter and one (1) company by LVT.

b. Company "I"

(1) Commencing H-hour on D-day land by helicopter in LZ MARTEN.

(2) Secure LZ.

(3) On order attack to the North in zone.

c. Company "L"

(1) Commencing H-hour on D-day land by helicopter in LZ MUSKRAT.

(2) Search sub hamlet of PHUOC HO (2) (BS 672975).

(3) Be prepared to continue the attack on order.

d. Company "M"

(1) Commencing H-hour on D-day land by helicopter in LZ MARTEN.

(2) Attack to the West in zone.

e. 81mm Mortar Platoon, H&S Co. 3/3

(1) Commencing H + 30 min on D-day land by helicopter in LZ MARTEN and establish firing positions.

(2) General support.

(3) Maintain two (2) firing sections at all times.

f. 107mm HOWITZER Btry. 3/12.

(1) On order land by helicopter in a zone to be designated.

(2) General support.

(3) Be prepared to retract by helicopter on the morning of D + 1.



g. Coordinating Instructions

- (1) H-hour 0600
- (2) ~~Day~~ 18 August 1965.
- (3) ~~Exercise~~ caution for mines and booby traps.
- (4) Spot reports on all contacts.
- (5) See Annex C (Operation Overlay)
- (6) See Annex D (Fire Support)
- (7) See Annex E (Air Support)

4. ADMINISTRATION AND LOGISTICS. See Administrative Plan 13-65.

5. COMMAND AND COMMUNICATIONS - ELECTRONICS

- a. Guard all radio nets commencing 180500H August 1965.
- b. Command Posts
  - (1) Command Group initially airborne. When established ashore CP vicinity Hill 83 (BS 648988).
  - (2) Companies report CP locations when established.
- c. Axis of Communications. See Annex C (Operation Overlay)
- d. See Annex F (Communications - Electronics)

*J. E. Muir*  
J. E. MUIR

Lieutenant Colonel, U. S. Marine Corps  
Commanding

ANNEXES

- A - Task Organization
- B - Intelligence
- C - Operation Overlay
- D - Fire Support Plan
- E - Air Support
- F - Communications - Electronics

DISTRIBUTION: Special

Annex C ( Operations Overlay) to operation  
Plan 13-35

Ref: (a) map: VIETNAM, 1:50,000, AMS,  
Series L701, 6757II, 6757III

Time Zones: H

62

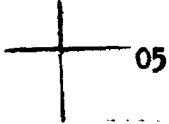

CONFIDENTIAL

3d Bn (Rein) 3d Marines  
CHU LAI, VIETNAM  
131400H August 1965

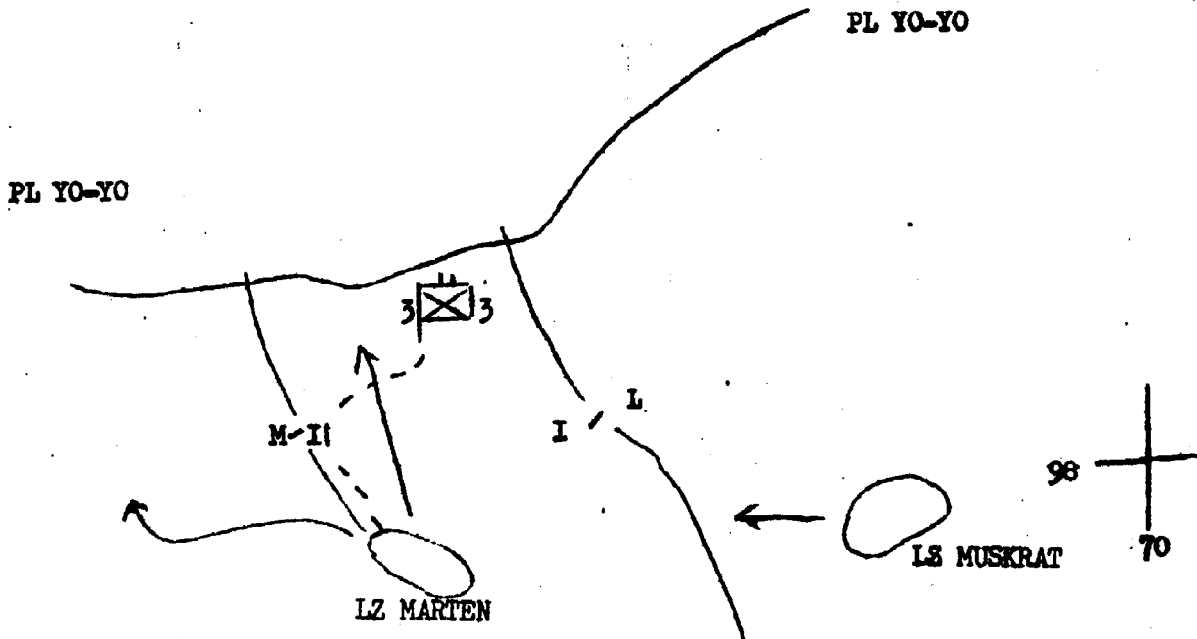

BY COMMAND OF LIEUTENANT COLONEL MUIR

*A. G. Conner*  
A. G. Conner  
Major, U. S. Marine Corps  
Executive Officer

DISTRIBUTION: Special

3d Bn (Rein) 3d Marines  
 CHU LAI, VIETNAM  
 160100H August 1965

Annex D (Fire Support) to Operation Plan 13-65

Ref: Map: VIETNAM; 1:50,000 Series L701, Sheets 6757II, 6757III

Time Zone: H

1. SITUATION. See Operation Plan 13-65.
2. MISSION. Provide fire support for Operation Plan 13-65.
3. EXECUTION
  - a. 81mm Mortar Platoon
    - (1) General support.
    - (2) Land in LZ MARTEN at h+30 on D-day and set up firing positions.
    - (3) Move with command group always maintaining two (2) firing sections
    - (4) Carry enough rounds to support operation on D-day.
    - (5) Resupply by helicopter.
  - b. 107mm Howtar Btry 3d Bn 12th Marines
    - (1) On order land by helicopter in a zone to be designated on the eveing of D-day.
    - (2) Direct support to 3d Bn 3d Marines.
    - (3) Be prepared to retract by helicopter on the morning of D+1.
  - c. Btry "C" 1st Bn 12th Marines
    - (1) General support, 4th Marines. Priority of fires to 3d Bn 3d Marine
  - d. 1st 8" Howitzer Pl.t., 1st 8"howitzer Btry, FMFPAC
    - (1) General support, 4th Marines. Priority of fires to 3d Bn 3d Marine
  - e. Btry "K" 4th Bn 12th Marines
    - (1) General support, 4th Marines, Priority of firs to 3d Bn 3d Marines.
  - f. 3d 155Gun Btry, FMFPAC
    - (1) General support 4th Marines. Priority of fires to 3d Bn 3d Marines

g. Coordinating Instructions

- (1) See Annex E (Air Support) to Operation Plan 13-65
- (2) Fire Support Coordination , Bn Order 3000.10 (SOP for Operations and Training)

4. ADMINISTRATION AND LOGISTICS. Normal

5. COMMAND AND COMMUNICATION & ELECTRONICS

- (a) FSCC land in LZ MARTEN and proceed to hill 83 on Phase Line YOYO with command group.
- (b) Communications. Normal.

BY COMMAND OF LIEUTENANT COLONEL MUIR

*A. G. Comer*  
A. G. COMER  
Major, U. S. Marine Corps  
Executive Officer

APPENDIX

1 - On Call Fires

DISTRIBUTION: Special

3d Bn (Rein) 3d Marines  
 CHU LAI VIETNAM  
 160100H August 1965

Appendix 1 (On Call Fires) to Annex D (Fire Support) to Operation Plan 13-65

Ref: Map: VIETNAM; 1:50,000 AMS L701 Sheets 6757II, 6757III

Time Zone: H

<u>CONCENTRATION</u>	<u>COORDINATES</u>	<u>TARGET</u>
CC 901	632961	Trail
CC 902	636964	Ambush area
CC 903	646963	Trail
CC 904	673966	"
CC 905	675956	"
CC 906	685965	"
CC 907	694968	"
CC 908	683972	Ambush area
CC 909	682976	LZ MSUKRAT
CC 910	652978	Critical terrain
CC 911	643975	LZ MARTEN
CC 912	633977	"
CC 913	624983	Caves
CC 914	624991	"
CC 915	648988	Critical terrain
CC 916	664985	Possible enemy position
CC 917	675985	Critical terrain
CC 918	683992	" "
CC 919	668991	Possible enemy position
CC 920	657999	Critical terrain
CC 921	639997	Caves
CC 922	623004	Hill
CC 923	635006	Critical terrain
CC 924	645004	Caves
CC 925	650005	Critical terrain
CC 926	663007	Trail
CC 927	671001	Critical terrain
CC 928	674021	Trail intersection
CC 929	666026	Escape route
CC 930	637023	Caves
CC 931	623018	Critical terrain
CC 932	666036	Critical terrain
CC 933	665047	Caves
CC 934	642055	

BY COMMAND OF LIEUTENANT COLONEL MUIR

A. G. COMER

Major, U. S. Marine Corps  
 Executive Officer

DISTRIBUTION: Special

D-1-1

3d Bn (Rein) 3d Marines  
 CHU LAI, VIETNAM  
 162100H August 1965

Operation Order 14-65

Ref: Map: VIETNAM; AMS L701, Sheets 6757II, 6757II, 6756I

Time Zone: H

Task Organization: Annex A (Task Organization)

1. SITUATION

a. Enemy Forces. Annex B (Intelligence)

b. Friendly Forces

- (1) RLT 7, commencing at 180630H August lands over BEACH GREEN and in Landing Zones RED, WHITE, and BLUE and attacks to the NORTHEAST
- (2) BLT 2/4, commencing at 180645H August lands in Landing Zones BLUE, WHITE, and RED, effects juncture with 3/3 and attacks to NORTHEAST.
- (3) Artillery
  - (a) Plat, Btry "K", 3d Bn 12th Marines direct support RLT-7
  - (b) Plat, 1st 155 Gun Btry (SP) FMF direct support RLT-7
  - (c) 107mm Howtar Btry, 3d Bn 12th Marines direct support RLT-7
  - (d) 2d Plat, 107mm Howtar Btry 3d Bn 12th Marines direct support BLT 3/3
- (4) DD- direct support BLT 3/3
- (5) 1st Marine Aircraft Wing provides CAS and helicopter support as required.

2. MISSION. Commencing 180630H August BLT 3/3 lands over BEACH GREEN and secures high ground in zone, prepared to continue the attack on order.

3. EXECUTION

a. Concept of Operation. BLT 3/3 lands by LVT with two (2) companies abreast and one (1) company in reserve in accordance with Annex D (Landing Plan) to Operation Order 14-65 and attacks to the NORTHEAST. One company infiltrate overland to blocking position on D-1.

b. Company "I"

- (1) Commencing 180630H August, land over South (left) portion of

**BEACH GREEN.**

- (2) Attack through AN CUONG (1) (BS 717922) and seize Hill 22 (BS 71592)
  - (3) Be prepared to continue the attack on order and clear the river line to the South.
  - (4) Once link up is made with BLT 2/4 maintain visual contact.
- a. Company "K" (Rein)
- (1) Commencing 180630H August land over NORTH (right) portion of BEACH GREEN.
  - (2) Attack and seize high ground to West in zone (BS 715928)
  - (3) Be prepared to continue the attack on order.
- d. Company "I" (Rein)
- (1) Commencing 170830H August land over Beach BLACK.
  - (2) Conduct search and destroy operations to South.
  - (3) Be in blocking position vicinity (BS 682975) by 180600H August.
  - (4) Prevent VC escape to the North.
  - (5) Receive by helicopter and provide security for, 107mm Howitzer Btry approximately 180720H August.
- e. 81mm Mortar Plat, H&S Co
- (1) Land over Beach GREEN in accordance with Annex D (Landing Plan) to Operation Order 14-65.
  - (2) General support
  - (3) Maintain two (2) firing sections at all times
- f. 3d Plat (Rein) Co "A" 3d Tank Bn
- (1) Commencing 180630H August land over South (left) flank of Beach GREEN.
  - (2) Direct support to Co "I" initially.
  - (3) Be prepared to revert to general support on order.

g. 3d Plat Co "B" 3d AT Bn

- (1) Commencing 180630H August, land over North (right) flank of Beach GREEN.
- (2) Direct support Co "K" initially.
- (3) Be prepared to revert to general support.

h. 3d Plat (Rein) Co "L" 1st Antrac Bn

- (1) Land over Beach GREEN in accordance with Annex D (Landing Plan) to Operation Order 14-65.
- (2) General Support.

i. BLT Reserve

- (1) Company "L" (Rein).
  - (a) Land over Beach GREEN and assemble vicinity (BS 715923).
  - (b) Be prepared for employment anywhere in battalion zone.

j. Coordinating Instructions

- (1) See Annex C (Operation Overlay).
- (2) See Annex D (Landing Plan).
- (3) Contact right to left.
- (4) Exercise caution for mines and booby traps.
- (5) Maintain visual contact.
- (6) Enemy will not be bypassed.
- (7) Report crossing of phase lines.
- (8) Spot reports on contact.
- (9) Emphasize EEI's. See Annex B (Intelligence).

4. Administration and Logistics. See Administration Order 14-65.

5. Command and Communication - Electronics.

- a. (1) See reference (b).
- (2) Radio silence until lifted by BLT order.
- (3) Guard radio nets commencing 180330H August.





b. Command Posts

- (1) RLT-7.....LSD -
- (2) BLT 3/3.....LST -
- (3) Report location ashore when established.

c. Axis of Communications. See Annex C (Operation Overlay).

*Joseph E. Muir*

JOSEPH E. MUIR  
Lieutenant Colonel, U. S. Marine Corps  
Commanding

Annexes:

- A. Task Organization
- B. Intelligence
- C. Operation Overlay
- D. Landing Plan

DISTRIBUTION: Special



3d Bn (Rein) 3d Marines  
 CHU LAI, VIETNAM  
 162100H August 1965

Annex A (Task Organization to Operation Order 14-65)

Ref: None

Time Zone: H

Task Organization

3d Bn (Rein) 3d Marines Lt Col MUIR

H&S Co (-)

NGF Liaison Tm 3d Bn 12th Marines

Arty Liaison Tm 1st Bn 12th Marines

3d Plat (-) Co "B" 3d Engr Bn

Det INT

Company "I" (Rein)

Co "I"

Capt WEBB

FO Tm 81mm Mortar Plat

FO Tm Btry "C" 1st Bn 12th Marines

Det 3d Plat Co "B" 3d Engr Bn

FAC Tm

Company "K" (Rein)

Capt DOUB

Co "K"

FO Tm 81mm Mortar Plat

FO Tm Btry "C" 1st Bn 12th Marines

Det 3d Plat Co "B" 3d Plat Co "B" 3d Engr Bn

NGF Spot Tm

Company "L" (Rein)

Capt MCDAVID

Co "L"

FO Tm 81mm Mortar Plat

FO Tm Btry "C" 1st Bn 12th Marines

Company "M" (Rein)

Capt MORRIS

Co "M"

FO Tm 81mm Mortar Plat

FO Tm Btry "C" 1st Bn 12th Marines

Det 3d Plat Co "B" 3d Engr Bn

81mm Mortar Plat (-)

Lt GIBSON

3d Plat (Rein) Co "A" 3d Tank Bn

Lt THOMPSON

Sec Flame Tanks

3d Plat Co "B" 3d AT Bn

Lt MCCOY

3d Plat (Rein) Co "A" 1st Antrac Bn

Lt BANNON

E.J. MUIR

Lieutenant Colonel, U. S. Marine Corps  
 Commanding

DISTRIBUTION: Special

A-1

3d Bn (Rein) 3d Marines  
 CHU LAI, VIETNAM  
 162400H August 1965

Annex B (Intelligence) to Operation Plan 14-65

Ref: (a) MAPS: VIETNAM, 1:50,000 AMS Series 1701, Sheets 6756 I, 6756 IV,  
 6757 II and 6757 III

Time Zone: H

1. SUMMARY OF ENEMY SITUATION

- a. See enemy situation overlay (Appendix 1).
- b. See current Isums as issued.

2. ESSENTIAL ELEMENTS OF INFORMATION

- a. Determine if VC opposition will be encountered during or subsequent to the landing, if so, in what strength?
- b. Do VC forces occupy Green Beach area from coord (BS 720918) to coord (BS 718927) so as to obstruct the landing, and if so, will they defend these areas?
- c. Will the VC be reinforced, if so, when, where, in what strength and by what means?
- d. Determine the identity, strength, composition and disposition of enemy forces located in area of operations.
- e. Determine VC sources of support, supply, and routes of infiltration.
- f. Determine if local civilian population will support our forces actively or be passive in their reaction while supporting the VC by covert means.
- g. Determine location of storage area for weapons and food.

3. RECONNAISSANCE AND OBSERVATION MISSIONS

- a. Orders to subordinate units
  - (1) All Companies
    - (a) Be prepared to conduct reconnaissance missions as directed.
- b. Requests to higher, adjacent and supporting units
  - (1) 7th Marines

CONFIDENTIAL

- (a) Provide information on enemy strength, disposition, and capabilities.
- (b) Provide current information on enemy disposition after operation commences.

c. Coordinating Instructions

- (1) Companies will notify this Headquarters (S-2) of evacuation of all VC/VCS, captured documents and materials including weapons, and any other pertinent intelligence information.
- (2) All Evacuation will be through the Regimental Collection Point coord (BT 520046).

4. INTELLIGENCE SUPPORT REQUIREMENT

- a. Request following assistance be provided or arranged for by the 4th Marines.
  - (1) Names and descriptions of any significant personalities within area of operation.
  - (2) Provide minimum of one English speaking ARVN interpreter per Company to assist with matters pertaining to intelligence and security.
  - (3) Provide one ITT Team to assist in initial intelligence determination

5. MEASURES FOR HANDLING PRISONERS, CAPTURED DOCUMENTS AND CAPTURED MATERIALS

a. Prisoners

- (1) All VCS will be interrogated by intelligence personnel at the Regimental Collection Point, coord (BT 520046) as soon after capture as possible.
- (2) All VCS will be tagged with the standard POW/Equipment tag. Tags will be filled out completely.
- (3) Companies will interrogate prisoners for information of immediate tactical information only.

b. Captured Documents

- (1) All captured documents will be tagged with time, coordinates where found, capturing unit, and description.
- (2) Documents will be evacuated with prisoners and turned over to the Regimental Collection Point as soon after capture as possible.

B-2

CONFIDENTIAL

c. Captured Material

- (1) All material, except documents and weapons, found on VC and VCS will be left on the individual until he is delivered to the Regimental Collection Point.
- (2) All weapons will be removed from prisoners by the capturing unit, tagged with completed tags, and turned in to the Regimental Collection Point as soon after capture as possible.

6. MAPS AND PHOTOGRAPHS

- a. In accordance with EnO 3800.1C.

7. REPORTS AND DISTRIBUTION

- a. See section VIII of EnO 3800.1C.

BY COMMAND OF LIEUTENANT COLONEL MUIR



A. G. COMER

Major, U. S. Marine Corps  
Executive Officer

APPENDIXES

- 1 - Enemy Situation Overlay
- 2 - Beach Study
- 3 - Counter Intelligence Plan

DISTRIBUTION: Special

3d Bn (Rein) 3d Marines  
CHU LAI, VIETNAM  
162400H August 1965

Appendix 1 (Enemy Situation Overlay) to Annex B (Intelligence) to  
Operation Plan 14-65

Time Zone: H

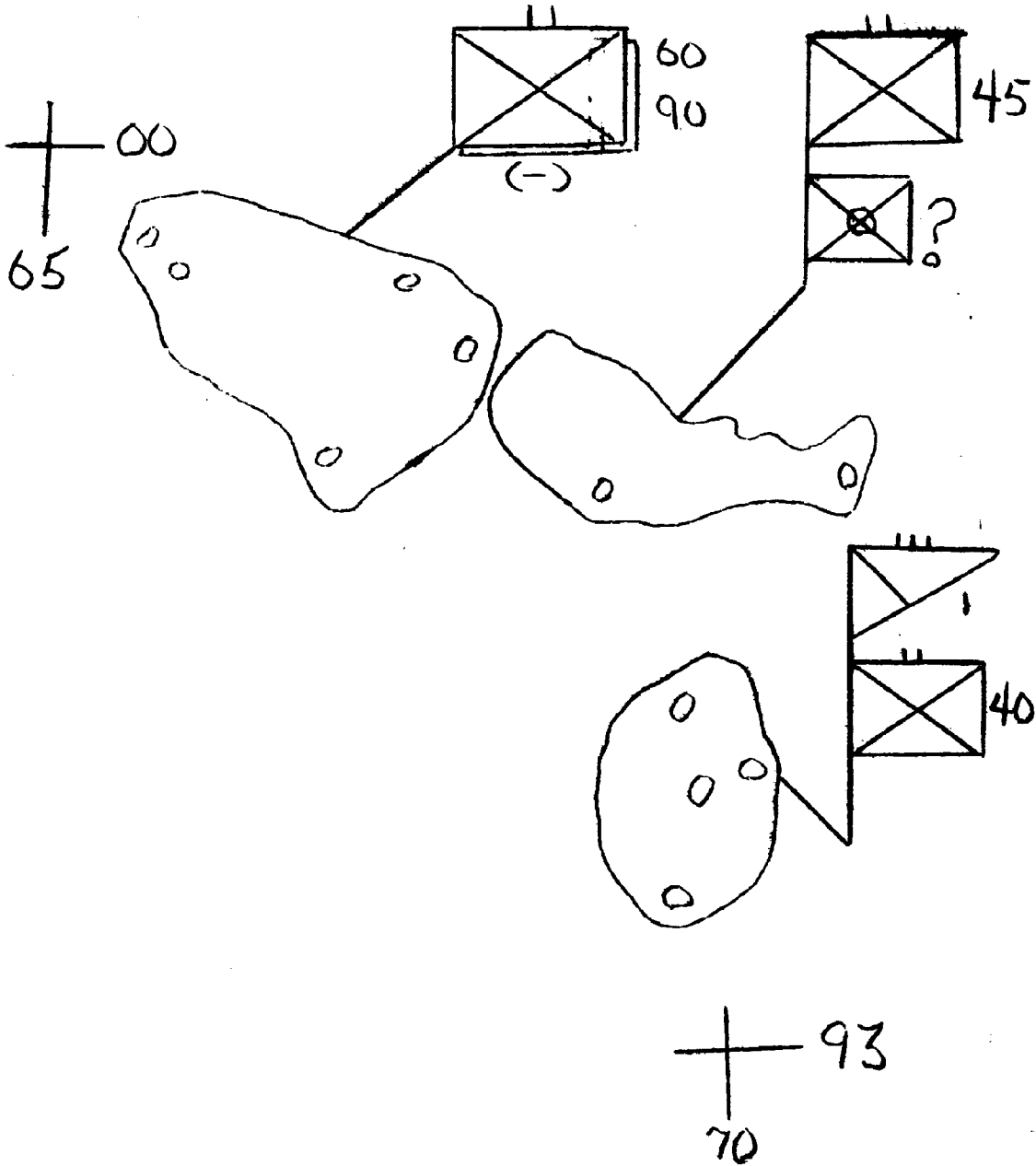

B-1-1

DECLASSIFIED

[REDACTED]

BY COMMAND OF LIEUTENANT COLONEL MUIR

*A. G. Comer*  
A. G. COMER  
Major, U. S. Marine Corps  
Executive Officer

DISTRIBUTION: Special

B-1-2

[REDACTED]

DECLASSIFIED

3d Bn (Rein) 3d Marines  
 CHU LAI, VIETNAM  
 162400H August 1965

Appendix 2 (Beach Study NIS Beach 12) to Annex B (Intelligence) to  
 Operation Plan 14-65

- Ref: (a) Joint Imagery Intelligence Center Detailed Imagery Intelligence  
 Report 106-64
- (b) MAP: VIETNAM, 1:50,000 AMS Series L701, Sheets 6756 I, 6756 IV,  
 6757 II and 6757 III

Time Zone: H

NIS BEACH 12

1. LENGTH AND WIDTH

Nine Kilometers in length, 46 to 146 meters wide at low water; 37 to 73  
 meters wide at high water.

2. GRADIENTS

Steep (1:5 to 1:55, low water to high water), steep (1:5 to 1:10 high  
 water zone)

3. APPROACHES

Nearshore bottom slopes gently to flat shoreward of the 1 fathom depth  
 contour 137 to 357 meters off high water line of SE half of beach and  
 gentle to mid shoreward of the 3 fathom depth contour 319 meters to  
 631 meters off high water line of NW half: 6 fathom depth contour 675  
 to 1183 meters off high water line; offshore approaches partly obstructed  
 by reef-fringed islands 25 kilometers NE of beach; nearshore approach  
 partly obstructed by reefs fringing unusable parts of beach; bottom  
 sand; anchorage in 5½ fathom depth 457 meters off SE part of beach;  
 anchorage bottom unknown.

4. SURF AND TIDAL RANGE

Surf 4 feet or greater can be expected to occur only 4% of the time with  
 a tidal range of 4 feet.

Tide Table - D-Day

HIGH TIDE is 3.5 feet at 0245

LOW TIDE is 2.9 feet at 0712



[REDACTED]

5. MATERIAL, FIRMNESS, AND EXITS

Sand, firm in wet areas, soft where dry. Exits cross country or by trails and unsurfaced roads leading inland from villages to surfaced National Route 1, 7 to 10 kilometers behind NW part of beach.

6. TERRAIN IMMEDIATELY BEHIND BEACH

Beach is backed partly by tree covered dunes extending 31 meters to 1 kilometer inland; dunes backed by extensive lowlands covered with rice fields and other cultivated fields and traversed by numerous streams bordered by salt pans; lagoons immediately backed by dunes behind central part of beach; isolated wooded hills on lowlands; villages at NW end of beach and on lowlands.

BY COMMAND OF LIEUTENANT COLONEL NUIR

*A. G. Comer*

A. G. COMER  
Major, U. S. Marine Corps  
Executive Officer

DISTRIBUTION: Special

3d Bn (Rein) 3d Marines  
CHU LAI, VIETNAM  
162400H August 1965

Appendix 2 (Counterintelligence Plan) to Annex B (Intelligence) to  
Operation Plan 14-65

Time Zones: H

1. GENERAL

a. The following conditions can be expected which will effect the security actions of all commands:

- (1) Hostile activity by unfriendly indigenous elements and/or enemy agents with missions of espionage.
- (2) Involvement with civilians in populated areas, including security problems.

2. MILITARY SECURITY

a. Security of Military Information

- (1) Commanders are directly responsible for the Military security training of their units and for the safeguarding of all classified matter in their command. Classified information will be handled in accordance with OPNAVINST 5510.1B.
- (2) No classified information will be taken forward of the Bn Command Post except as absolutely required in the conduct of operations.
- (3) Access to classified information and material will be limited to US personnel. In addition, the following measures will be taken:
  - (a) Surveillance of known or suspected enemy agents
  - (b) Control of civilian movements as required
  - (c) Security classification and control of plans, orders, and reports
- (4) Units will thoroughly police command posts upon displacement to insure that no documents or objects of possible value to the enemy have been left behind

- (5) Personnel will not carry personal documents with exception of I.D. Cards, Dog Tags and Geneva Convention Cards on their person which would be of value to the enemy in case of capture or loss.
- b. Code of Conduct. All personnel will be instructed in the Code of Conduct for members of the Armed Forces.
- c. Security, Discipline and Training
- (1) Personnel will be instructed on security of Military information, personnel censorship and proper use of challenge and passwords.
  - (2) Personnel will be instructed as to what articles may not be carried into combat. Prohibited items include unit leader notebooks and personal radios.
  - (3) Personal records and diaries will not be maintained by members of this command.
- d. Counter-subversion
- (1) Attempts at subversion of friendly forces through use of propaganda by the enemy will be reported to this Headquarters (Attn: S-2).
- e. Classification. Operation Plans will be classified "CONFIDENTIAL" or higher if warranted.
- f. Sign and Countersign. To be issued.
3. CIVIL SECURITY
- a. Civil Leaders
- (1) All civilian leaders claiming to be friendly will be considered as "gray personalities" until their names and loyalties can be verified by this Headquarters. They will not be treated as prisoners during verification, but will be closely watched.

BY COMMAND OF LIEUTENANT COLONEL MUIR

*A. G. Comer*  
 A. G. COMER  
 Major, U. S. Marine Corps  
 Executive Officer

DISTRIBUTION: Special

B-3-2.

3d Bn (Rein) 3d Marines  
G.I. B.I., VIETNAM  
170200H August 1965

Annex D (Landing Plan) to Operation Order 14-65

Ref: (a) FMFM 6-3

Time Zone: H

1. GENERAL

a. This plan calls for:

- (1) Landing one BMT across Beach GREEN with two (2) companies abreast.
- (2) Landing of scheduled waves to be by LVT, LCU, and LCU.
- (3) The landing of the battalion reserve and 81mm mortar platoon by LCU.

b. For detailed instructions see appendixes.

2. CONTROL MEASURES

a. ship-to-shore control in accordance with ref (a).

b. Tac-log group organizes and functions in accordance with reference (a) and Administrative Order 14-65.

BY COMMAND OF LIEUTENANT COLONEL FUHR

A. G. COMAR  
Major, U. S. Marine Corps  
Executive Officer

APPENDICES:

- 1. Landing Diagram
- 2. Landing Craft and Amphibious Vehicle Assignment Table

DISTRIBUTION: Special

OFFICIALS:

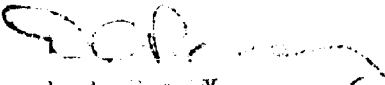
  
D. A. Ramsey  
Captain, U. S. Marine Corps  
S-3

3d Bn (Rein) 3d Marines  
 CHU LAI, VIETNAM  
 170200H August 1965

Appendix 1 (Landing Diagram) to Annex D (Landing Plan) to Operation Order 14-65

Ref: (a) FMFM 6-3

Time Zone: H

LANDING DIAGRAM

H-HOUR 0630

Beach GREEN

WAVE 1	Co. "I" and Co. "K"										
H-Hour	1-1	1-2	1-3	1-4	1-5	1-6	1-7	1-8	1-9	1-10	1-11
	X	X	X	X	X	X	X	X	X	X	X
WAVE 2	TANKS			AND			Ontos				
H+2 min	2-2			2-1			2-3				
	U			M			M				
WAVE 3	Co. "L" AND 81mm MORTAR PLATOON										
H+75min	3-2					3-1					
	M					M					
WAVE 4	TANKS										
H+25min	4-1										
	U										
WAVE 5	ONTOS										
H+50min	5-2					5-1					
	M					M					
WAVE 6	TANKS										
H+50min	6-1										
	U										
WAVE 7	TANKS AND H&S Co. (-)										
H+75min	7-2			7-1				7-3			
	M			U				M			
LEGEND:	X.....LVTP			U.....LCU				M.....LCM			

BY COMMAND OF LIEUTENANT COLONEL MUIR

A. G. COMER  
 Major, U. S. Marine Corps  
 Executive Officer

DISTRIBUTION: Special

OFFICIAL:

D. A. RAMSEY  
 Captain, U. S. Marine Corps  
 S-3

D-1-1

3d Bn (Rein) 3d Marines  
 CHU LAI, VIETNAM  
 170200H August 1965

Appendix 2 (Landing Craft and Vehicle Assignment Table) to Annex D (Landing Plan) to Operation Order 14-65

Ref: (a) FMFM 6-3

Time Zone: H

CRAFT	PERSONNEL AND MATERIAL	BOAT SPACES	FORMATION
LVTP 1-1	1st Plat Co "I"	25	1-1
	1st Tm 3.5 1st Sqd	2	X
	1st Tm M.G. 1st Sqd	3	1-2
	Sqd Ldr 1st MG Sqd	1	X
LVTP 1-2	Plt Sgt 1st Plat Co "I"	1	1-3
	2d Tm 3.5 1st Sqd	2	X
	2d Tm M.G. 1st Sqd	3	1-4
	Company Commander	1	X
	Radiomen	2	1-5
	Company Gunnery Sgt	1	X
	Company Armorer	1	1-6
	Co Driver	1	X
	81 FO Tm	2	1-7
	Plt Cmr Wpns Plat	1	X
	Sect. Ldr MG Sect	1	1-8
	1st sqd 2d Plat Co "I"	8	X
	Plt Cmr 2d Plat	1	1-9
	Messenger 2d Plat	1	X
Sqd Ldr 2d Sqd M.G.	1	1-10	
1st MG Tm 2d Sqd	2	X	
1st FT 2d Sqd 2d Plt	3	1-11	
LVTP 1-3	Sqd Ldr 2d Sqd 2d Plat Co "I"	1	
	Grenadier 2d Sqd 2d Plat	1	
	2d FT 2d Sqd 2d Plat	3	
	1st 3.5 Tm 2d Rocket Sqd	3	
	2d MG Tm 2d Sqd	2	
	3d Sqd 2d Plat	10	
	Guide 2d Plat	1	
	Corpsman 2d Plat	1	
	Sqd Ldr 2d Sqd 3.5	1	
	Plt Sgt 2d Plat	1	
	Sect Ldr 3.5	1	
	1st Sqd Ldr 1st Sqd 3d Plat	1	
	Grenadier 1st Sqd 3d Plat	1	
	1st & 2d Ft 1st Sqd 3d Plat	6	

D-2-1

GRAFT	PERSONNEL AND MATERIAL	BOAT SPACES	FORMATION
LVTP 1-4	3d FT 1st Sqd 3d Plat Plat Cmdr 3d Plat Messenger 2nd Sqd 3d Plat Sqd Ldr 3d MG Sqd 1st Team MG 3d Sqd 3d Sqd 3d Plat Corpsman 3d Plat Plat Guide	3 1 1 11 1 3 10 1 1	
LVTP 1-5	2nd Team MG 3d Sqd Corpsman 3d Plat Plat Sgt 3d Plat Co XO Plat Sgt Weapons 1st Sgt Radioman Assistant Armorer Chief Corpsman Mule Driver	4 1 1 1 1 1 1 1 1 1	
LVTP 1-6	1st Plat Co "K"	30	
LVTP 1-7	1st Plat Co "K" 81 FO Tm Co Runners Co Radiomen	22 2 2 2	
LVTP 1-8	Co CO Co Gysgt Arty FO Senior Corpsman Arty Radioman Co Runner Co Radioman 2nd Plat	1 1 1 1 1 1 1 1 23	
LVTP 1-9	2nd Plat 3d Plat	22 6	
LVTP 1-10	3d Plat	30	
LVTP 1-11	3d Plat Co XO Co Radioman Wpns Plat GP	16 1 1 1 3	

CRAFT	PERSONNEL AND MATERIAL	BOAT SPACES	FORMATION
LCM 2-1	2 Ontos 6 Crew		2-1 M 2-2 U      2-3 M
LCU 2-2	3 Tanks 15 Crew		
LCM 2-3	2 Ontos 6 Crew		
LCM 3-1	81mm Mortar Platoon		3-1 3-2 M M
LCM 3-2	Co. "L"		
LCU 4-1	Tanks		4-1 U
LCM 5-1	Ontos		5-1 5-2 M M
LCM 5-2	Ontos		
LCU 6-1	Tanks		6-1 U
LCU 7-1	Tanks		7-1 U 7-2 7-3 M M
LCM 7-2	H&S Co. (-)		
LCM 7-3	H&S Co. (-)		

BY COMMAND OF LIEUTENANT COLONEL MUIR

A. G. COMER  
Major, U. S. Marine Corps  
Executive Officer

DISTRIBUTION: Special

OFFICIAL:

*D. A. Ramsey*  
D. A. RAMSEY  
Captain, U. S. Marine Corps  
S-3

D-2-3



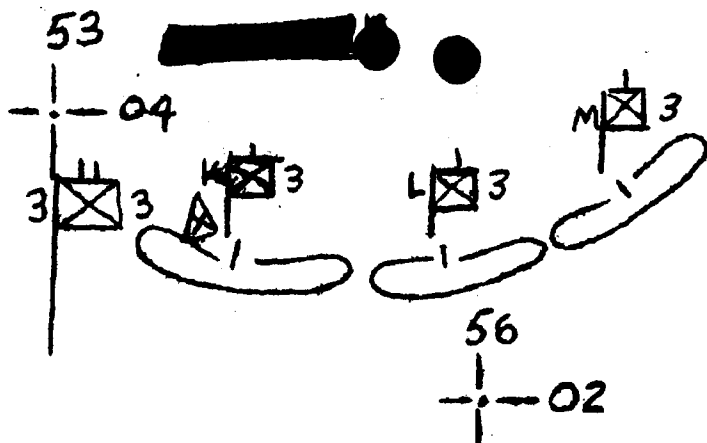

3d Bn (Rein) 3d Marines  
 CHU LAI, VIETNAM  
 272000H August 1965

Frag Order #35

Ref: (a) Map: VIETNAM; 1:50,000, AMS Series L701, Sheets 6757III, 6756IV

Time Zone: H

1. SITUATION

- a. Enemy Forces. Current INTSUMS
- b. Friendly Forces. No change
- b. Attachments and Detachments. No change

2. MISSION. 3d Bn 3d Marines occupies tactical bivouac along assigned portion of MRP.

3. EXECUTION

- a. Concept of Operation. Effective 27 August 1965 3d Bn 3d Marines will be relieved by 1st Bn 7th Marines and establish a tactical bivouac.
- b. Effective 280600H Company "L" detach one (1) reinforced rifle platoon to 1st Bn 4th Marines.
- c. Companies "K" and "M" shift to cover the sector vacated by Company "L".
- d. H&S Company (Rein) occupy and defend the new CP location (BT 530022).

4. ADMINISTRATION AND LOGISTICS. Normal

5. COMMAND AND COMMUNICATIONS

- a. Battalion OP (BT 550022)
- b. Communications - Radio

JOSEPH E. MUJR  
 Lieutenant Colonel, U.S. Marine Corps  
 Commanding

DISTRIBUTION: Special

3d Bn (Rein) 3d Marines  
CHU LAI, VIETNAM  
030930H August 1965

3d Bn (Rein) 3d Marines After Action Report #32

1. Unit: 3d Bn, 3d Marines (-) (Rein), 3d MarDiv (Rein) FMP

Strength: 53 Officers, 466 Enlisted, 6 PW's, 1 ARVN Officer, 4 ARVN Interpreters

Time: 060550L to 071515H August 1965

Place: Area as indicated in 3d Bn, 3d Marines Operation Order 10-65 also, see appended overlay

Casualties: Two (2) KIA

Nature of Action: Search and Destroy

2. General. The battalion (-) (Rein) conducted a search and destroy operation in an area as indicated on appended overlay. The entire battalion (-) (Rein) was helilifted to and from the area of operations.

a. At 060706H the battalion (-) boarded helicopters at LZ LOON (BT 568022) and moved to LZ WOLF (appended overlay). At 050810H the entire battalion (-) was landed and executing 3/3 Operation Order 10-65. At 060823H Company "I" found one (1) VC hiding in a stream (BS 529854). At 060823H Company "M" began receiving small arms fire from TRA BINH (BS 553858). The company quickly returned fire and briefly had the VC pinned down at (BS 540860); however, the enemy finally filtered into the dense undergrowth that characterized the terrain. At 060930H, Company "I" moved on to TRA BINH and found several packs containing clothes, medicine, VC uniforms, food, cooking utensils and toilet articles at (BS 533857); four (4) VCs were apprehended in the vicinity of the packs. At 061120H Company "I" found one (1) wounded VC at (BS 534887) and evacuated him (DOA) back to the Bn CP. At 061200H three (3) more packs with clothing and food along with one (1) carbine and five (5) magazines were found in the vicinity (BS 552861). At 061200H a second carbine was found while searching the immediate vicinity of the wounded VC previously mentioned. At 061230H Company "I" received several rounds of small arms fire (BS 532865). Fire was returned with unvisible results. At 061241H Company "M" found eight (8) land mines (BS 547856); four (4) of them antipersonnel bounding type and four (4) home made mines. All were destroyed in place by Engineers. The battalion moved on to the night defensive positions vicinity (BS 570864) without further incident arriving at 061640H. At 061700H the resupply and Howtar's for the night defense, arrived. During the preparation of the night defense, Company "I" received two (2) WIA's at 061712H from a pressure type mine vicinity (BS 572858). One man was evacuated, while the other Marine incurred only superficial wounds and was returned to duty. Throughout the night, the battalion conducted h&i fires expending 158 Howtar rounds and thirty-two (32) 81mm rounds. No contact was made with the enemy during the night. At 070730H, the battalion moved onward to Phase Line FOXROT (appended overlay) arriving at 071325H. The entire movement from the night defensive positions to the conclusion of the operation was conducted without incident.

At 071337H the battalion began helilifting back to the MLR. The retraction was completed by 071515H.

### 3. Remarks

a. The zone of action assigned for this operation was too large for the battalion to adequately cover. The terrain and vegetation was such that two (2) companies were unable to conduct a thorough search in the time allowed.

b. HOWLERS were to be brought into the night defensive positions at a time to be designated. They were brought in early and before the battalion was ready to receive them. This resulted in confusion and congestion of air traffic in the landing zone.

c. Auxiliary water cans should be kept on helicopters that are used for evacuations. When a Marine succumbs to heat exhaustion his companions use all their water to cool him off and give him comfort; consequently, several Marines are left without water and they become potential heat casualties. This becomes a vicious circle. If water cans were carried on the helicopters men could refill their canteens on the spot. Provisions would have to be made for recovery of water cans.

d. Communications maintenance is essential. During this operation six (6) AN/PRC-10's ceased to function for a variety of reasons. Three (3) of these were put back into action by a technician in the field. This is a desirable practice and is recommended for future operations. Only a small quantity of tools must be carried for quick field repair.

e. Aerial photographs were invaluable for planning. It is recommended that photos of the area of operation be made available to company commanders in the amount of two (2) copies per company.

f. One interpreter per company is inadequate for offensive operations over a wide zone of action. He is just not there when needed, because he is involved with some other platoon. One (1) interpreter per platoon is considered satisfactory.

g. Helicopter availability was changed at the last moment and the battalion was not notified. This necessitated a change of the landing plan at the loading zone.

h. While representatives from various news media are always welcome, it is felt that the battalion should be advised as to how many are expected to appear. Heliteams are planned ahead of time and unexpected riders merely confuse the issue.

*J. E. Muir*  
J. E. MUIR

Lieutenant Colonel, U. S. Marine Corps  
Commanding

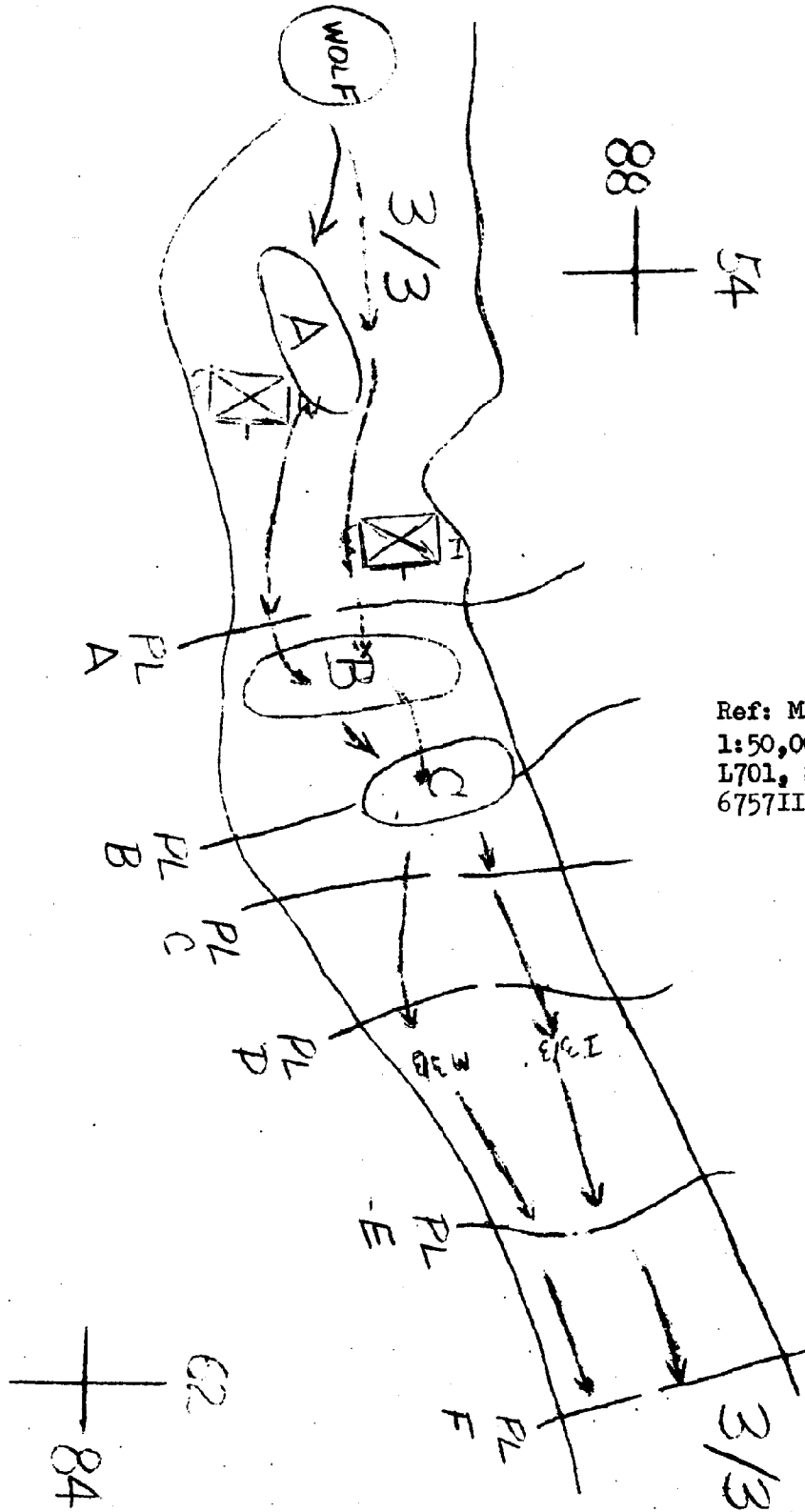

Ref: Map: VIETNAM:  
1:50,000, AMS Series  
L701, Sheets 6757II,  
6757III, 6756I, 6756IV

3d Bn (Rein) 3d Marines  
 CHU LAI, VIETNAM  
 131400H Aug 1965

3d Bn (Rein) 3d Marines After-Action Report #32

Ref: (a) DivOpO 321-65

1. Unit: Company "I" 3d Bn 3d Marines (Rein) 3d MarDiv FMF

Strength: 7 Officers, 159 Enlisted, 2 Interpreters, 2 PF's and 3 Civilian correspondents

Time: 110730H - 120915H August 1965

Place: Area enclosed by (BS 6298) (BT 6201) (BT 6503) (BS 6798) (BS 6298)

Casualties: three (3) Marine WIA

2. General. Company "I" conducted search and destroy operations on the TRUNG PHAN Peninsula. The company was carried to the peninsula by LVT's and retracted by helicopter.

a. At 110845H Company "I" landed at (BT 653037) and began moving inland on a search and destroy operation. At 111000H the company moved to (BT 646009) where a brief fire fight was held with an estimated four (4) VC. No casualties were incurred. The fire fight was almost coincidental with a brief skirmish at (BT 651011) where S-2 scouts also received small arms fire. Although the VC escaped, one of the enemy did drop his ID Card. The company was taken under fire from a hill (BT 650005). An attempt was made to encircle the hill, however; the enemy, two men cornered in brush were able to escape into the dense underbrush. At 111130H sniper fire was received from vicinity (BT 656000). No casualties. The company moved onward with scouts covering the forward movement and were taken under fire at (BS 653994) from the vicinity of (BS 659992) where an armed VC in black clothes was seen retreating. The village of DONG LE (4) (BT 660015) was searched but met with negative results. The company moved to (BS 657999) where tunnels were found and blown. At (BS 639988) the company again received small arms fire. The enemy escaped through the brush and into a village at (BT 630003). Small arms was received and VC were sighted at (BT 623004), artillery fire was called in on the VC position and the company made an assault. During the course of action, the Marines received two (2) WIA's. At 111615H, the company CP at (BS 635000) received small arms fire and five (5) rounds of 60mm mortar fire. No casualties. Artillery was directed on to the suspected VC position. One (1) Marine received a minor wound by small arms during the incident. At 111845H vicinity (BS 631986) during the resupply, the company received heavy small arms fire from (BS 630995). The VC were able to escape again. There was no further action until 120540H when the ambush at (BS 632984) opened fire on six (6) VC. The VC escaped however one man was believed wounded. At 120640H while moving from (BS 632984), the company was taken under a heavy volume of fire from an estimated VC squad at (BT 633984). Fire was returned with no observed results. The company began retraction by helicopter at 120810H and was completed by 120910H.

  
3. Remarks

a. The VC were willing to snipe at the Marines and were well prepared in that they had excellent avenues of escape whenever the Marines gave chase.

b. Communications hindered effective pursuit in that during the maneuvering of the elements of the company, communications was often negligible. A reliable radio for distances to five (5) miles is required for company, platoons, and squads.

4. Recommendations

a. That ambush sites not be predetermined, rather the sites should be picked during movement in daylight hours and the size of the ambush be set by the terrain and action of the day.

b. That company operations be 3 - 7 days in duration. Flexibility is lost by trying to meet time schedules for resupply and evacuation from an operation area.

BY COMMAND OF LIEUTENANT COLONEL MUIR

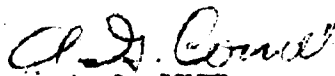

A. G. COMER

Major, U. S. Marine Corps  
Executive Officer

3d (Rein) 3d Marines  
 CHU LAI, VIETNAM  
 231400H August 1965

UNCLASSIFIED

3d Bn (Rein) 3d Marines After-Action Report #33

Ref: (a) DivOpO 321-65

Encl: (1) Company "I" After-Action Report  
 (2) Company "K" After-Action Report  
 (3) Company "L" After-Action Report  
 (4) Company "M" After-Action Report ✓

1. Unit: BLT 3/3

Strength: 46 Officers and 882 Enlisted Marines.

Time: 171000H - 201925H August 1965

Place: Area of operations enclosed by (BS 719919 - BS 700920 - BS 697926  
 BS 700940 - BS 713962 - BS 732952)

Casualties: Friendly - KIA 2/22, WIA 3/112, DOW 0/3  
 Enemy - 215 Confirmed Kills.

Nature of Action: Operation STARLIGHT

2. During the aforementioned period, the battalion participated in Operation STARLIGHT, an operation which started as a routine search and destroy mission, but which escalated into a BLT offensive action. The first element of BLT 3/3 to approach the objective area was Company "M" which landed by LVT across a beach to the north in the vicinity of (BT 650034) on D-1 at 171000H and commenced movement overland by foot. The remainder of the BLT embarked aboard amphibious shipping and sailed for the objective area during the afternoon and night of 17 August 1965. Company "M" established a blocking position vicinity (BS 683971) at about 180600H (H-30min) and the BLT landed across Beach GREEN vicinity (BS 718922) at H-hour (180630H) with Company "I" on the left (Beach GREEN ONE), Company "K" on the right (Beach GREEN TWO) in LVT's and Company "L" in reserve landed in LCUs and LCMs. Tanks and Ontos were also landed in the scheduled waves by LCP's and LCM's. A large charge of explosives was detonated on the beach in front of Company "I" on landing, however it had no effect and the Company pushed on through the sub-hamlet of AN CUONG (1) vicinity (BS 717922). Company "K" moved through the northern edge of the sub-hamlet without incident and secured Hill 22 (BS 715924) Company "L" in the second wave received heavy small arms fire from the right flank of the beach on landing. The company was immediately committed to the attack toward Phase Line APPLE and the firing ceased. Two Marines were slightly wounded. Companies "I" and "K" continued their movement westward. Company "K" turned to the northeast in the vicinity of (BS 708928) and moved toward Phase Line APPLE. Company "I" executed a flanking movement to the northeast in the vicinity (BS 702922) and was taken under heavy small arms fire from the left flank in the 2/4 zone of action (BS 703923). The company was directed to attack the source of the fire (AN CUONG (2) (BS 701928)) reinforced by a heavy section of

UNCLASSIFIED

UNCLASSIFIED

tanks and commenced the attack across the stream. During the course of the assault the Commanding Officer, Company "I" was killed in action by an enemy fragmentation grenade. Three members of his party were wounded. The company also received a small amount of 60mm mortar fire wounding three more. After the sub-hamlet was secured, Company "I" returned to the 3/3 zone of action and commenced sweeping in a northeasterly direction toward Phase Line APPLE. At this time (181115H) a disabled UH-1E landed near Company "I" positions and ten (10) Marines with three tanks were left behind to guard the aircraft. At this time Company "K" was receiving a heavy volume of automatic fire in the vicinity of (BS 714938) and went into the attack to overcome the resistance. At this time (181225H) five (5) LVT's full of supplies (rations, water) were taken under small arms, mortar, and recoilless rifle fire vicinity (BS 698932) as they were attempting to reach the battalion position. Company "I" was dispatched to the scene to assist the LVT's at 181305H. At approximately 181400H Company "I" was again taken under heavy fire vicinity (BS 703927) which inflicted several casualties. Companies "K" and "L" continued their attack to the north and at 181525H Company "K" became engaged in a fire fight which resulted in several friendly casualties, however Companies "K" and "L" assaulted the hill vicinity (BS 713942) and established a perimeter of defense at about (181550H). Meanwhile, Company "I" recovered the ten (10) Marines at the downed UH-1E and a platoon of Company H 2d Battalion 4th Marines that was pinned down by enemy fire and was continuing the advance to reach the LVT's but was suffering rather heavy casualties which impeded their progress somewhat. At approximately 181600H Company "L" 3d Battalion, 7th Marines landed vicinity (BS 708927) and were assigned to operational control of BLT 3/3. Company "L" 3d Bn, 7th Marines reinforced with a light section of tanks, and a tank retriever from Company "B" 1st Tank Battalion were assigned the mission of effecting juncture with Company "I" 3d Bn 3d Marines vicinity (BS 700930). Company "L" 3d Bn 7th Marines moved but at approximately 1730H with two platoons abreast followed by the tanks. As they approached the preassigned juncture point they came under extremely heavy small arms and mortar fire from the west. The company continued its attempt to cross the open rice paddy in the area but was unable to do so because of the intense enemy fire. As darkness fell patrols were dispatched to the north and to the west to locate Company "I", the tanks, and the LVT's. The patrol to the north was unsuccessful; the patrol to the west returned and reported locating one burning tank and one disabled LVT vicinity (BS 698926). Two courses of action were proposed; one to close the remainder of the battalion with Company "L" 3d Bn 7th Marines. second to move Company "L" 3d Bn, 7th Marines into the battalion perimeter at (BS 713942). After communicating with Company "I" as to their situation and a determination that they had the means available to adequately overcome the VC resistance that they were encountering, a decision was made to execute a night movement of Company "L" 3d Bn, 7th Marines to the BLT 3/3 perimeter. At the same time two tanks formerly in support of Company "H" 2d Bn 4th Marines moved to the resupply LVT's to increase the defensive capability in that area. These tanks arrived at approximately 182300H. At 182330H Company "L" 3d Bn 7th Marines commenced its movement to the battalion perimeter, arriving 190130H. Company "I" remained in the village in contact with the VC until 190145H when it began its return to the battalion secondary command post arriving at 190500H. Company "I" was then assigned the mission of providing security for the RLT CP and the beach area. Company "L" 3d Bn 7th Marines upon arrival at BLT 3/3 area, was integrated into the defensive perimeter for the night. On the morning of 19 August 1965 BLT 3/3 received a

UNCLASSIFIED



UNCLASSIFIED

Frag Order narrowing its zone of action to the east, and BLT 3/7 (-) was assigned the mission of recovering the LVT's. BLT 3/3 was assigned the mission of continuing the attack to the sea in zone. The battalion jumped off to the north with Company "K" 3d Bn 3d Marines on the left, Company "L" 3d Bn 3d Marines on the right and Company "L" 3d Bn 7th Marines in reserve at approximately 190700H. The zone of action was prepared with naval gunfire and artillery prior to the commencement of the attack. The battalion moved toward the beach, against sporadic resistance. As the force reached Phase Line CHERRY Company "L" 3d Bn 3d Marines, Company "K" 3d Bn 3d Marines and the battalion command group came under intense small arms and mortar fire from (BS 712957). The battalion moved quickly to the dune line just inboard of the beach and returned the fire. Artillery and air strikes were called in on the VC positions and the fire ceased. At 191710H after intensive preparation of the zone of action by air, artillery, and naval gunfire, BLT 3/3 continued the attack to the south with Company "L" 3d Bn 7th Marines on the left, Company "L" 3d Bn 3d Marines in the center, and Company "K" 3d Bn 3d Marines on the right. On arrival at Phase Line BANANA the BLT established a defensive perimeter at BS 713943. Company "K" 3d Bn 3d Marines and Company "L" 3d Bn 3d Marines closed at approximately 191855H. Company "L" 3d Bn 7th Marines was delayed due to evacuation of heat casualties. A platoon from Company "L" 3d Bn 3d Marines was attached to the company for assistance and the entire unit arrived in the BLT area at 192140H. A defensive posture was maintained during the night with heavy H&I fires being provided by artillery and naval gunfire. The following morning patrols were sent out from each company to locate any by-passed VC pockets of resistance. All returned reporting no contact. At approximately 201050H Company "K" 3d Bn, 3d Marines, Company "L" 3d Bn 3d Marines and the Executive Officers group commenced movement southward toward Beach GREEN arriving without incident at 201240H. The Commanding Officer Group, Company "L" 3d Bn 7th Marines and the 3d Plat, Company "B", 3d AT Bn remained to receive BLT 1/7 and guide them into position. BLT 1/7 commenced landing at approximately 201330H and the Commanding Officers Group of BLT 3/3 commenced movement to Beach GREEN at 201440H arriving at 201550H. Retraction followed shortly and the BLT set sail for CHU LAI aboard LST 1161.

### 3. Remarks.

a. During Operation STARLIGHT, BLT 3/3 used naval guns extensively for preparatory fires, illumination and flushing fires. The BLT was supported quite satisfactorily by the naval guns as far as accuracy and volume were concerned. The illumination is excellent. The time required to obtain the first round of naval gunfire was often too long due to the requirement of positioning the ship. It is believed this discrepancy will not exist in operations where the planning phase is longer than thirty-six (36) hours. However, anticipating that other operations will be undertaken on short notice, it is recommended that this important supporting arm be given all possible planning time. On the evening of D+1 the fire support ship that had been registered was changed after dark. Re-registration was required and was a difficult task. It is recommended that once a ship has the night defensive fires laid in and has moved to, she should not be changed unless out of ammunition.

UNCLASSIFIED

UNCLAS

b. Artillery support, while extremely effective once delivered, was slow to the point of being unsatisfactory because of so much traffic on the conduct of fire net. The only agencies on a single conduct of fire net should be the supporting battery, the FO's and the liaison team. BLT 3/7 and BMT 3/3 were both on the same conduct of fire net and was to difficult to enter the net when fire missions were required. It is recommended that on future operations each BLT have its own conduct of fire net.

c. Wide zones of action are permissible on routine search and destroy operations, however there is a definite need for a maneuver element when the BLT meets resistance. If the BLT is assigned a wide zone of action it has a choice of two courses of action. It may put all available companies on line for a more thorough search or it may keep one element in reserve thereby decreasing the efficiency of the search. Usually the former course of action is preferred. On future operations where contact with a strong enemy force is expected it is recommended that a narrow zone of action be assigned so that a thorough search can be conducted and so that a maneuver element may be available for reaction to heavy resistance.

d. Preparatory fires were used extensively on D+1 with excellent effect. It is recommended that preparatory fires be used to the maximum extent practicable on future operations to reduce friendly casualties. It is also recommended that fires be delivered behind the advancing unit to discourage snipers from shooting from the rear.

e. Close air support during Operation STARLIGHT was very good. Aircraft were available, there was a minimum of delay, and pilots were on target. U. S. Marine close air support was the most responsive supporting arm during the operation and it was a distinct pleasure for all hands to observe such accurate and timely support. There were four occasions of friendly aircraft dropping bombs or strafing too close to friendly lines, however, no serious casualties occurred.

f. Confirmed enemy kills break down as follows:

Company "I"	125
Company "K"	20
Company "L"	6
Company "M"	5
H&S Company	12
LVT's, Tanks and Ontos	47
	<u>215</u> Total VC dead

UNCLASSIFIED

*Joseph E. Muir*  
 JOSEPH E. MUIR  
 Lieutenant Colonel, U. S. Marine Corps  
 Commanding

Company "I" 3d Bn 3d Marines After-Action Report

Ref: (a) DivOpO 321-65

1. Unit: Company "I" 3d Bn 3d Marines

Strengths: 7 Officers, 170 Enlisted

Time: Duration of Operation, 180630H - 201700H August 1965.

Place: Area as indicated in Operation Order 14-65

Casualties: Company "I" - KIA 14, WIA 47, Attachments 2 Corporal WIA, 1 Corporal KIA, 1 Arty WIA, 2 GI PO's WIA

Nature of Action: Amphibious Assault followed by search and destroy

2. General. Company "I" landed over the South (left) portion of Beach GREEN to conduct a search and destroy operation against the Viet Cong. Company "I"'s mission was to sweep the village of AN CUONG (1) pushing in a westerly direction until contact was made with the right flank of 2d Bn 4th Marines. When contact was made in the area of coordinates (BS 703926), the company mission was to make a flanking movement, sweeping generally in a north northwesterly direction reaching by the end of the first day the ocean in the area of coordinates (BS 717958). The next day resweeping the same area.

a. At 180730H Company "I" landed over the southern portion of Beach GREEN. An explosion occurred just as the ramps were dropping on the LVT's. No one was injured. The company formed on line and proceeded to search the village. The only significant find was communication wire running from the explosive point to a trench line 150 meters to the rear. It appeared as if an electrical charge was set off to disrupt our landing. After searching the village the company moved out to the west and discovered a covered trench line, which lead to two cave systems, at (BS 714923). A search of the caves revealed only digging tools. The company continued forward and started its turning movement to the North at (BT 702922). At this point an air strike occurred to our right flank and the company held up. Two (2) superficial WIA's were sustained at this time. It is suspected that the injury's were the results of bomb fragments. After the strike, the company continued its sweep to the North. The company began receiving heavy fire from the village of AN CUONG (2) (BS 700928). The fire was returned and permission from Battalion Commander was requested to cross over into 2/4 sector and engage the enemy in this village. During this time we were accompanied by three (3) tanks from Co "A" 3d Tanks who were protected by a squad from the 1st Plat Company "I". After receiving permission from the Battalion Commander to sweep AN CUONG village, the tanks were sent down a trench line that stretched East to West bordering the Southern edge of the village, 1st plat was deployed on the left, 2nd on the right and the third in reserve. The 1st and 2nd platoons assaulted the trench line and into the village along with the tanks who reached the trenchline and were unable, due to the width of the trench line, to advance further. As the 1st and 2nd plcts

UNCLASSIFIED

entered the village the CP group followed close behind. At this time a concealed Viet Cong threw a grenade which killed the Company Commander, and wounded three (3) others. Following the grenade explosion two (2) rounds of 60 mm mortars fell in the area wounding the artillery FO and the two (2) FO's from 81's. At this time the Company Executive Officer assumed command of the company. After contacting the Battalion Commander, the company was instructed to continue the attack to the north. Before continuing the attack a Marine UH-1E helicopter landed to our immediate rear with its gas tanks full of bullet holes. Upon instruction of Battalion, a ten (10) man squad was left to protect the UH-1E, as were the tanks, which were unable to cross the trench line. We were under no fire at this time and counted approx 30 VC dead in the trench line and village. The company moved through the village and proceeded north, shifting slightly to the east back into the company Z/A. We received only occasional sniper fire until we rejoined Company "K" and the Battalion Headquarters Group at approximate coord (BS 711939). Upon arriving at the area of the Bn CP the company was ordered to board Amtracs and Ontos to return to grid coordinates (BS 720928) where the Bn Supply point was set up under the direction of the Bn Executive Officer. "I" Company's mission was to locate and attack the enemy force that had isolated a tank and LVT supply column. After a briefing by the Battalion Executive Officer it was decided to proceed down the trail to the west back to the village of AN CUONG (2), coord (BS 700928) where Company "I" had left the three (3) tanks and two (2) squads to protect the helicopter. One (1) tank in the lead, followed by five (5) Amtracs and five (5) Ontos. As we got to the top of the ridge line coord (BS 703927) the lead tank was hit by a 57mm RR and stopped. We started deploying immediately while several 81mm mortar rounds dropped in on our position. We immediately deployed around the vehicles but only a few sniper rounds were directed into our position. We then turned our attention to the wounded and called for helicopter evacuation. The results of the mortar barrage on the Amtracs resulted in five (5) dead and seventeen (17) wounded. After the first helicopters arrived, a small evacuation team was left behind to get the wounded out. The company then advanced to the edge of AN CUONG (2) village and covered the withdrawal of a platoon of Company "H" 2d Bn 4th Marines along with the three (3) tanks and two squads of Company "I" left behind to provide security for the downed helicopter earlier in the day. During the time Company "I" was going up to Company "K" positions several events occurred. The crew of the helicopter repaired the gas leaks and dropped the rocket pods leaving instructions to the security personnel to blow the rockets. This was done with a team of engineers of Company "H" 2d Bn 4th Marines. After the pods were blown, one (1) platoon of Company "H" 2d Bn 4th Marines joined by three (3) tanks and two (2) squads from Company "I" proceeded to advance to the north whereupon they engaged a large force of VC at approx (BS 701931). After suffering several casualties they withdrew back to coord (BS 702927) where they were covered by Company "I" who arrived in the area. The casualties sustained in this engagement were fifteen (15) WIA and two (2) KIA. Since the helicopter evac landing zone was receiving increasing sniper fire Company "I" left back the 2d platoon for area security. At this time we were brought under 81mm mortar fire. An air strike on AN CUONG (2) village was called for but failed to arrive. The two (2) platoons of Company "I" then advanced west to coord (BS 698927) and began sweeping north in an attempt to locate the supply column when we engaged a VC force at coord (BS 700930) resulting in one (1) KIA and

A12 MAY

UNCLASSIFIED

one (1) WIA. The V.C. lost six (6) KIA. This contact occurred at around 1930. The V.C. broke contact and a helicopter evacuation was conducted for the two casualties. By the time the evacuation was completed it was dark. We were unable to locate supply train and were ordered to return back to Grid. Coordinates (BS 704927) where Company "I" second platoon and a platoon from Company "H" 2d Bn 4th Marines were located, then return back to the 7th MarinCP to provide security for the CP. Our return back was hampered by continuous illumination. We were fired upon on two occasions and returned fire. We surprised six (6) VC in the village and killed them and returned back to grid coordinates (BS 704927) around 190345H. There we gathered up our second platoon and a platoon from Company "H" 2d Bn 4th Marines and proceeded back to the Regiment CP. and set up security. We stayed at the Regiment CP the 19th of August and retracted around 1700 20 August 1965

*R. M. Purnell*  
R. M. PURNELL  
Lieutenant U. S. Marine Corps  
Commanding

ENCLOSURE (1)

UNCLASSIFIED

3

## Company "K" 3d Bn (Rein) 3d Marines After-Action Report

Ref: (a) DivOpO 321-65

## 1. Units: Company "K" 3d Bn 3d Marines (Rein) 3d Mar Div FMF

Strengths: 8 Officers 161 enlisted

Time: 180700H to 201500H August 1965

Place: As prescribed by 3d Bn 3d Marines Operation Order 14-65

Casualties: Company "K" KIA 2, WIA 16  
Enemy Killed 20 Wounded 18

Nature of Action: Amphibious assault followed by search and destroy

2. Company "K" (Rein) landed on the right flank of Beach GREEN and was immediately taken under fire by automatic weapons from the extreme flank of the beach area. 1st platoon searched right portion of village, AN CUONG (1) coord (BS 718924) the 2d and 3d platoon pushed through right half of beach neutralizing fire and proceeding inland in prescribed axis of advance. 2nd Plat secured high ground, located Coord (BS 712925) and 3d Plat secured high ground Coord (BS 715928). 1st Plat in reserve. 2nd Plat then moved forward and secured high ground located Coords (BS 709928). On order 2nd and 3d Plats moved out in a Northerly direction. At (BS 714938) 2nd and 3d Plats came under heavy automatic fire from left flank and trench line directly in front. 1st Plat came from reserve and assaulted to left, 2nd Plat assaulted straight ahead over hill and 3d Plat moved up to hill on right flank. Company set in night defenses coord (BS 715942). After setting in, naval gunfire and air were called in on enemy troop concentrations located at (BS 714947) to (BS 718945). Arty was also called but never got on target. Naval gunfire was observed in area where troops were noted and numerous secondary explosions were observed as a result of one air strike. Naval gunfire was also used by Co "K" for H&I fires throughout the night. At 190700 Co "K" moved out to village located at (BS 710945). Prior to moving through the village and high ground located along (BS 711949) to (BS 713953) an air strike was called. Co "K" passed through village and proceeded to high ground at above Coord. Prior to starting to beach, naval gunfire was called on (BS 708958) to (BS 711957). Arty and Air were also called in same area. While moving to beach located at (BS 701962), Co "K" came under fire at (BS 712961). 1st Plat moved to clear high ground (BS 708961). 2nd and 3d Plats moved down beach and assembled vic coord (BS 727924). At 191730 and returned to previous nights defensive positions. Naval gunfire H&I were again used throughout night. At 201100H Co "K" moved and swept to beach GREEN and set in defensive positions along left flank. At 201500H Co "K" commenced back loading. See overlay to Operation Order 14-65 for overlay of operations.

3. Remarks. All hostile villages, trench lines, and ridge lines Should Be Prepared regardless of civilian casualties prior to jumping off. Company Zones of Action should be small enough to give Company Commander ability to

ENCLOSURE (2)

UNCLASSIFIED

~~CONFIDENTIAL~~

employ a maneuvering element. Naval gunfire produced a salutary effect on all targets. Air Support was also commendable. Arty support was inefficient and delay time was inexcusable. Resupply by Amtrac proved not to be feasible and should not be planned more than 1000 meters inland. Zones of Action were too wide for thorough and proper search. Adjacent ~~MS~~ must cover areas of responsibility and must not bypass large pockets of enemy activity. For future operations more prior planning be effected and more flexibility be shown in execution of Basic Order. No interpreters were attached to this unit.

J. A. DOUB  
Captain, U. S. Marine Corps  
Commanding

UNCLASSIFIED

ENCLOSURE (2)

~~CONFIDENTIAL~~

3d Bn (Rein) 3d Marines  
 CHU LAI, VIETNAM  
 232115H August 1965

Company "L" 3d Bn (Rein) 3d Marines After-Action Report

Ref: (a) DivOpO 321-65

1. Unit: Co "L" 3d Bn 3d Marines (Rein) 3d Mar Div FMF

Strength: 6 Officers 161 Enlisted

Time: 180700H to 201500H August 1965

Place: As prescribed by 3d Bn 3d Marines Operation Order 14-65

Casualties: Company "L" KIA 2, WIA 16  
 Enemy Killed 0 Wounded 1

Nature of Action: Amphibious assault followed by search and destroy

2. At 180700H August 1965 Company "L" (Rein) landed in the center of Beach GREEN at (BS 718924). We immediately moved on the double to the right flank of the beach. The 1st Platoon was taken under fire by enemy in the tree line using small arms and at least one (1) automatic weapon. The remainder of the company still moving up the beach was also receiving fire. I moved the 3rd Platoon to the right to flank the fire and brought the 2nd Platoon into the center. Due to the crowded type landing, it took the platoon a short time to come on line and start advancing. To cover the hill I took an Ontos that was sitting on the right flank of Co "K" and moved him into the fire. His machine gun jammed and he started using his spotting rifle. The crew chief distinguished himself in this action and continually exposed himself to direct fire; He could not fire his 106's because of the closeness of the terrain and the troops behind the Ontos. To further cover the area I brought in a M-60 MG to the left of the Ontos. The Gunner was Pfc BOAST who also particularly distinguished himself by moving into the open on the top of a small hill into direct fire, where he calmly set in his MG with the incoming cutting the leaves around him. He opened fire and with fire from the Ontos, secured the incoming. We moved forward with three (3) platoons on line into our Zone of Action continually receiving light to moderate small arms fire. At coord (BS 718928) a very large cave network was found which was later blown by the Engineers. During this early action we received one (1) WIA, wounded slightly in the left upper arm, not evacuated. Under sporadic fire the company, three (3) platoons on line, moved across Phase Line APPLE. Between PL APPLE and PL BANANA, the company received fire from Hill #45 and to the Northeast (BS 720939). This fire was moderate and continuous. Fire was returned with 3.5, MG, and small arms. In excess of twenty (20) VC were seen at one time or another moving on hill. The company was being held at this time. Artillery was called with poor accuracy, next 81's with some improvement. Ontos platoon arrived and the hill was raked, with good accuracy. When the company was allowed to move forward, no further fire was encountered. Upon arrival on Hill #45 with the 3d and 2nd Platoon, I was called to WH 5

UNCLASSIFIED

1

ENCLOSURE (3)



CONFIDENTIAL

position. The 1st Platoon was at this time moving toward its objective. As I was departing from my CP I (and my party) received accurate sniper fire from the area into which the 1st Platoon was to move. I waited until 1st Platoon had passed and then moved to WH 6 position. Company "L" next moved to night position around 3/3 CP with Company "K". The morning of 19 August 1965, Company "L" jumped off with Co "K" and Co "L" 3/7 on a sweep to the sea. One (1) prisoner was taken (confirmed VC) and one (1) family desiring to escape the VC was picked up. Hostile fire was not incurred until the vicinity of coord (BS 726952). At this time the 1st and 3d Platoon had already moved across to the sand dunes. At that time I told the 2nd Platoon to investigate. They moved out into the open toward the fire followed by Lt BEDNAR. They continued to move under moderate fire until redirected by Lt BEDNAR toward the beach as they were moving into Company "K" area and L/3/7. I had no radio contact at this time with the 1st or 2nd Platoon. The 2nd Platoon arrived in the beach area and joined with 1st and 3d Platoon. While at the beach, the company received light to moderate small arms fire that was fairly accurate. Fire was returned. Fire support was given to Co "K" until requested to secure. Sniper fire continued. At this point we received enemy mortar fire. A round landed in the 2nd Platoon area, killing one (1) and wounding eleven (11). Lt SWARTZ immediately ran into the area and removed smoking WP 3.5 rounds from the vicinity to prevent further injury. The CP Corpse men immediately went to the aid of the injured. They were evacuated. The two (2) corpse men with the 2nd platoon were wounded but elected to remain with the company. The company started to sweep back to our previous position at 1700H. Half-way back Sgt MOORE and the 3rd Platoon were detached and sent back to find and bring in Co "L" 3/7, which he did with great efficiency. The company set in for the night and the next morning swept the left flank of the road returning to the beach. Nothing remarkable was noted. Some additional packs were uncovered and a VC body. Numerous VC packs were encountered during the operation some with much explosive content. A VC claymore mine was also uncovered. While waiting on the beach, the 3d Platoon was utilized to search the caves where documents etc. (including the body and claymore) were found. The company withdrew leaving the 2nd Platoon as a rear guard.

J. E. McDAVID  
 Captain, U. S. Marine Corps  
 Commanding

UNCLASSIFIED

ENCLOSURE (3)

Company "M" (Rein) 3d Marines  
 CHU LAI, VIETNAM  
 232115H August 1965

Company "M" 3d Bn (Rein) 3d Marines After-Action Report

Ref: (a) DivOpO 321-65

1. Unit: Co "M" 3d Bn 3d Marines (Rein) 3d Mar Div FMF

Strength: 7 Officers 177 Enlisted

Time: 171000H to 201925H August 1965

Place: As prescribed by 3d Bn 3d Marines Operation Order 14-65

Casualties: Company "M" one (1) WIA  
 Enemy Killed 5 Wounded 2

Nature of Action: Search and Destroy, Blocking, Radio Relay, Security

2. Company "M" (Rein) departed area at 171000H and proceeded to (BT 650034) by LVT's. Conducted search and destroy operations moving in Southerly direction moving in a tri-axis of advance along ridge lines (BS 656013) to (BT 667995) and (BS 650007) to (BT 658997) and valley floor between ridges. Receiving two (2) sniper rounds from approx (BS 663007) at 171430H. Could not make contact. Found one (1) M-1 and one (1) grenade w/out pin in "C" ration can at (BS 657998), it was destroyed. One (1) man was slightly wounded by Booby Trap grenade at (BT 652005) at 171505H. Spent night at (BT 667995) where we received two (2) sniper rounds which came from the Northeast from a long range. The company moved out at 180100H and proceeded to (BT 683971) where we arrived at 180420H. The area was secured and the Company proceeded to dig in. Whisky Btry started to arrive at 180930H. Security was provided. Co "G" 2/4 arrived at 181500 and set in to the West of the Company area. Day and night patrols were sent out during the entire period. One (1) Plat (Rein) patrol was sent out at 190630H with the mission of securing and establishing an outpost position at (BS 700975) while moving up the hill they sighted 12 VC moving along the ridge in a Southerly direction. They (the VC) were taken under immediate fire and five (5) bodies were found when Marines reached the area. This Marine platoon probably was taken for a VC unit by 2/4 Marines as an air strike was run from the East to the West and although three (3) 250 lb bombs fell within 100 meters from the platoon, noone was hurt prior to our getting the air strike stopped. During the evenings of 18 and 19 August the Company and Btry was hit by 3" 58 Naval gunfire star clusters and HE shells. These did not explode and most were later destroyed. No further action took place on the 20th and the company started retraction by Helo at 201835H and the last unit arrived back in the Bn Area at 201925H.

3. Remarks

a. Forcing troops to keep spread out pays off. Only one man was wounded by the tripped booby trap.

1

ENCLOSURE (4)

UNCLASSIFIED

DECLASSIFIED

b. There is a need for close, constant communications between units to avoid inflicting friendly casualties.

C. M. MORRIS  
Captain, U. S. Marine Corps  
Commanding

UNCLASSIFIED

2

ENCLOSURE (4)

DECLASSIFIED

## DECLASSIFIED

2/8

OVERLAY LEGEND  
PERIOD COVERED

311200H July to 071200 August 1965

- (1) Three vendors apprehended at 021715H vicinity (BT 559015) (Co. "L").
- (2) Two (2) men dressed in black with rifles sighted at 022024H vicinity (BS 622936) (Recon).
- (3) Seven (7) men in black unloading boat sighted at 030010 vicinity (BT 622002) (Recon).
- (4) Four (4) VCS with rifles dressed in black sighted at 031706H vicinity (BT 625002). Later at same coordinates four (4) men with weapons dressed in black at 031715H. At 031725H five (5) more men in camouflage uniforms some with packs sighted at same coordinates (Recon).
- (5) At 051920H twenty three (23) armed VC sighted vicinity (BT 625003) (Recon).
- (6) At 043920H Recon requested evacuation from vicinity (BT 623002). Two (2) platoons of Co. "MF" dispatched to carry out mission. (Recon).
- (7) At 053000H Recon evacuated from vicinity (BS 628975). Helicopter received SA fire (Recon).
- (8) At 044240H Women screening vicinity (BT 558014) (Co. "I").
- (9) At 051830H six (6) to eight (8) VCS observed unloading large boxes and supplies from boats (BT 644052). Arty fire called in, 36 rounds fired. (HEI 33)
- (10) At 062740H one (1) Marine KIA by stray round from PF fire fight ... vicinity (BS 568954).

DECLASSIFIED

10-2-11

SITUATION OVERLAY 3/3

Period Covered

311200H to 071200H Aug 66 - w/ Encl #11

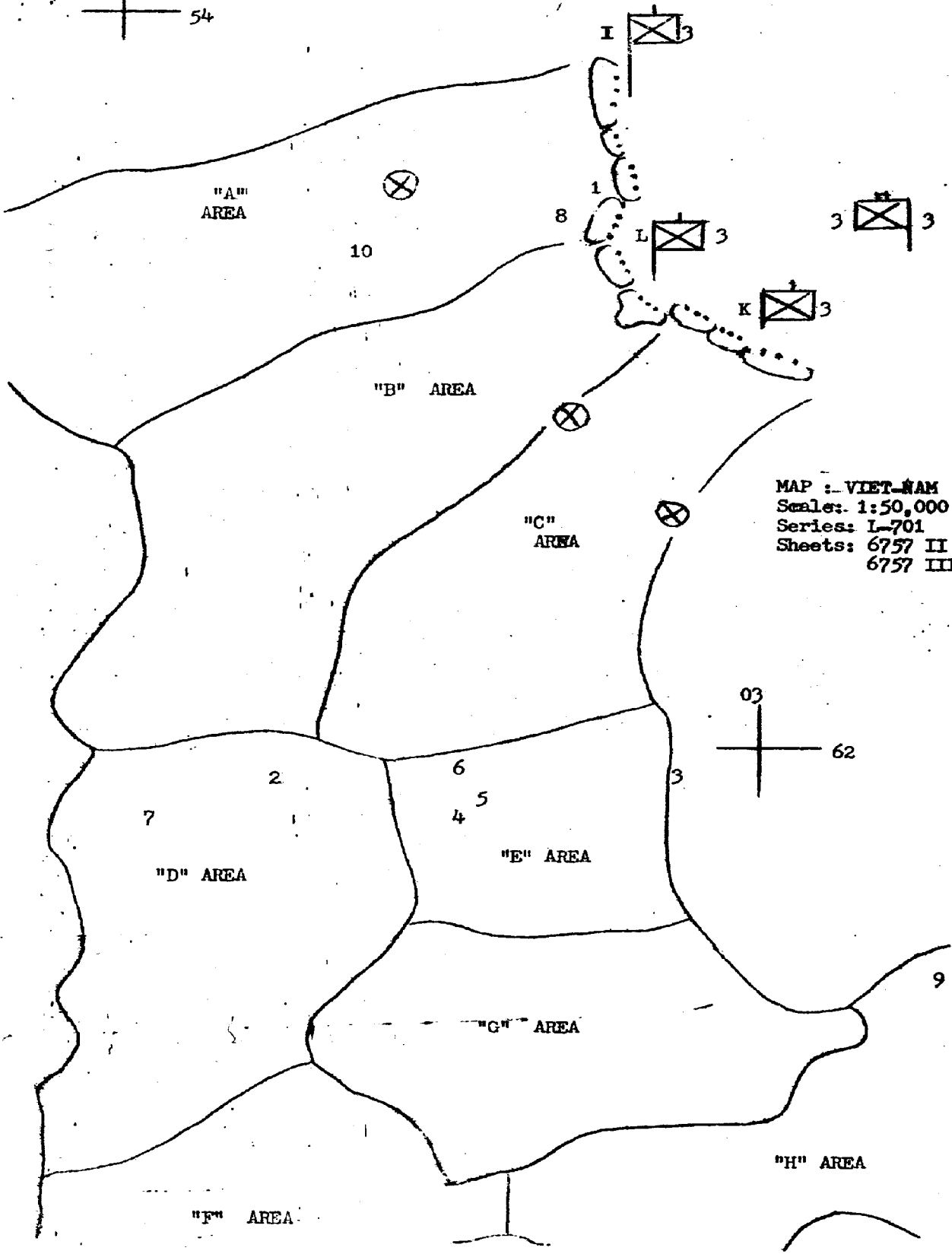
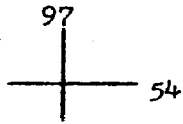

MAP : VIET-NAM  
Scale: 1:50,000  
Series: L-701  
Sheets: 6757 II  
6757 III

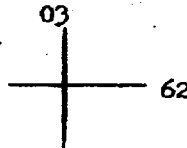

DECLASSIFIED

3/3

OVERLAY LEGEND  
WEEKLY SITUATION OVERLAY  
070500H - 140800H August 1965

- (1) At 070930H Chinese fragmentation grenade (BS 587865) (Co "L") See Overlay 2
- (2) At 092245H OP #1 received small arms fire. (BS 567996) one (1) VC killed. (Co "I")
- (3) At 110830H an H&S Co. patrol apprehended two (2) VN males (BT 563036) (H&S Co.)
- (4) At 111615H ten (1) VC (two (2) of which appeared wounded) sighted (BT 643003) (Co. "I")
- (5) At 111630H one (1) S-2 Scout WIA (BT 623004) (Co "I")
- (6) At 111650H two (2) Marines WIA (BS 635995) and (BS 630992) (Co "I")
- (7) Five (5) rounds of 60mm Mortar received (BS 560992) (Co "I"), (111645H).
- (8) At 111800H Helicopter received SA fire (BS 629992)

DECLASSIFIED

Small #12

2/3  
SITUATION OVERLAY

Period Covered  
070000H to 140000H August 1965 w/Encl 12

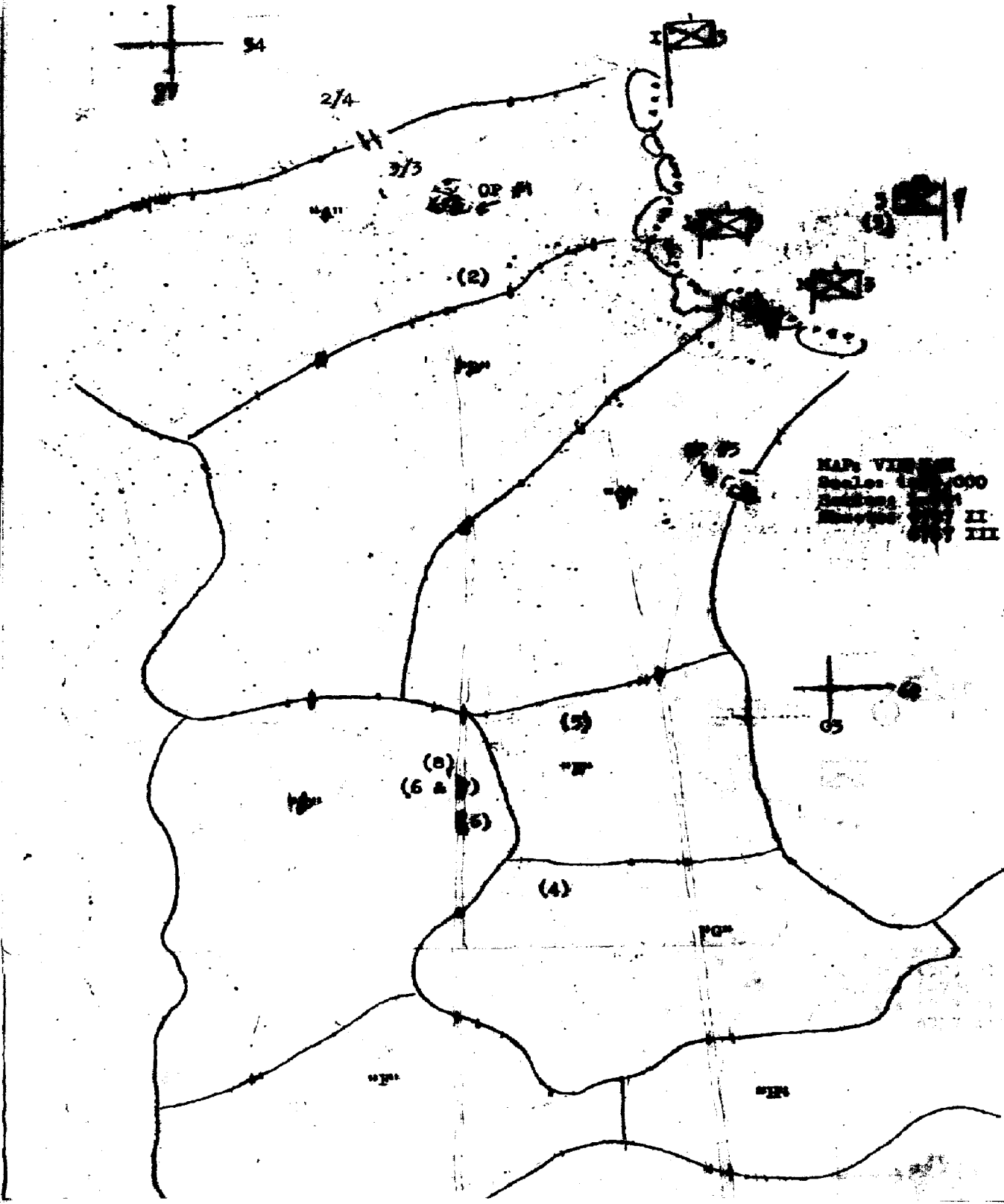

WIKLEY SITUATION OVERLAY

SHEET #2

Period Covered.  
070000Z to 140000Z August 1965

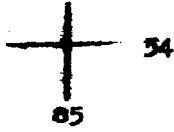

MAP: VINT HALL  
SCALE: 1:50,000  
SOURCE: L-704  
SHEETS: 6757 I  
6758 IV

(1)

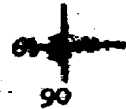



DECLASSIFIED

3d Battalion, 3d Marines  
Situation Overlay Legend  
140800H to 210800H August 1965

- (1) Company "M" reported ten (10) VC with packs and weapons on hill (BT 650004), taking them under fire. Time of sighting 140855H. Neg results.
- (2) At 140930H Company "M" received small arms fire from (BS 666986). No casualties.
- (3) At 140950H thru 141020H VC sighted at following coordinates 3 (BS 655995) 3-A (BT 650005) 3-B (BS 661991) and 3-C (BS 668993). Company "M" was taken under SA fire from last three (3) coordinates, but maintained contact and continued to pursue. No casualties.
- (4) At 141155H Company "M" found a large mock-up map drawn on the side of a building at coord (BS 660992). Pictures were taken of the map and building destroyed.
- (5) At 141300H three (3) VC sighted at coord (BS 666996). All had weapons. No contact made with Company "M".
- (6) At 141315H Company "M" requested Arty mission on suspected mortar position coord (BS 664984). Position destroyed.
- (7) At 141320H Company "M" found one (1) VC dead at (BS 655999) VC had a Russian HE Rkt launcher with two (2) rounds.
- (8) Company "M" reported another VC dead at 141405H at coord (BT 654001) His equipment included weapons cleaning gear, ammo, cartridge belt, and three (3) grenades. No weapon was on body.
- (9) At 141745 Company "M" forwarded twelve (12) VCS to 3/3 collection point. VCS were taken at coord (BS 663993).
- (10) At 142220H, the Bn CP received one (1) rd of carbine fire from south on left flank. No casualties. Coord BT 568043.
- (11) At 152245H Company "L" received SA fire from vic coord (BT 568013) and returned fire at two (2) VN males moving through the brush. Negative results and no casualties.
- (12) At 160320H Company "I" received one (1) grenade at (BT 549013). No casualties and negative results from returned fire.

End #13

DECLASSIFIED

2/3 20 Cont = 13

SITUATION OVERLAY

Period Covered  
140800H To 210800H  
August 1965

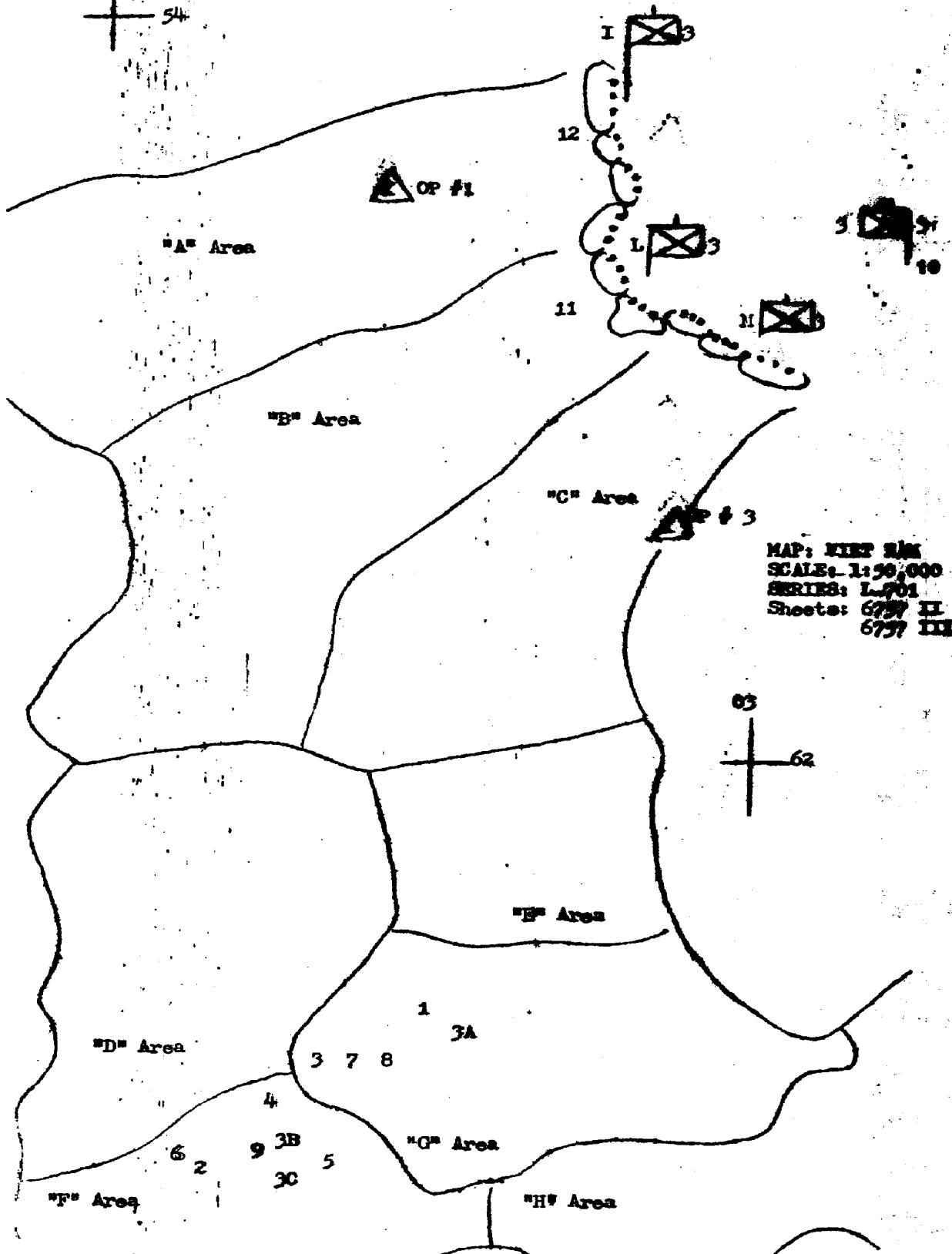
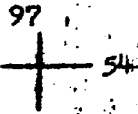

MAP: KINT S/M  
SCALE: 1:50,000  
SERIES: L-701  
Sheets: 6757 II  
6757 III

3/E, Aug 65  
OVERLAY LEGEND

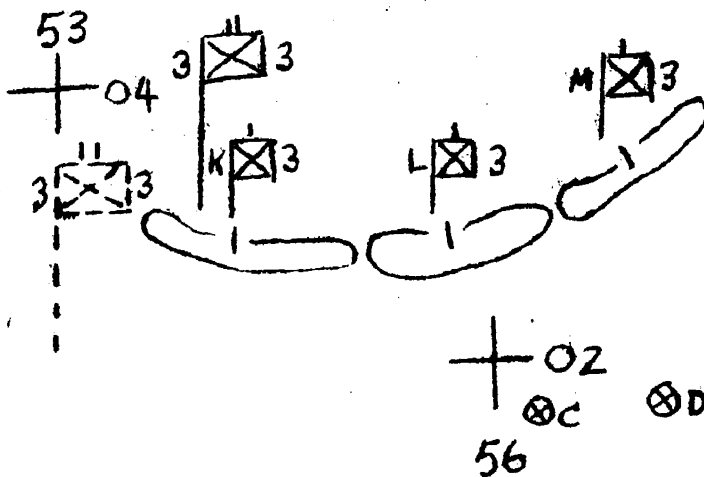

MAP: VIETNAM  
Scale: 1:50,000  
Series: L-701  
Sheets 6757II  
6757III

Period covered 220800H to 280800H

<u>When</u>	<u>Who</u>	<u>What</u>	<u>Where</u>	<u>Action</u>
260030H	Co "M"	3 Sniper Rds	(BT 602014)	Continued patrol encountered no further incidents. No casualties.
252140H	Co "K"	1 Sniper Rd	(BT 555001)	Illuminated, saw nothing, R; casualties, no further action taken.
250830H	Co "L"	1 Sniper Rd	(BT 573017)	No Casualties, no action taken.
222313H	Co "L"	1 Mortar Rd	(BT 564017)	1 WIA was evacuated, no action taken, no further incidents.

HEADQUARTERS

3rd Battalion, 3rd Marines, Marine #23  
3rd Marine Division (Rein), FMF  
c/o Fleet Post Office  
San Francisco, California, 96601

3/DAR/lne  
3000  
22 August 1965

From: Commanding Officer  
To: Commanding Officer, 4th Marines

Subj: Lesson's Learned on Operation "Thunderbolt".

Encl: (1) Lessons Learned

1. Enclosure (1) is forwarded for information.
2. The lessons herein are a product of the executive and special staff's comments plus those of attached units. They have been screened and only those which are considered to be of value to all unit leaders are submitted.

*J. E. Muir*  
J. E. MUIR

DECLASSIFIED

PLANNING

Item: Information must flow down as well as up.

Discussion: The flow of information must go both ways. The battalion is required to submit timely, accurate and complete reports to higher headquarters. Information which flows down to the battalion should be of the same quality. When sightings of the enemy are made by aerial observers and relayed to battalion they should include such information as how many? In what direction were they traveling? Where were they sighted? Time of sighting. Were they armed? If not, how are they to be recognized? and so on.

Recommendation: That all staffs review their information flow and ensure that complete, accurate reports are made.

Item: The Landing Plan changed on the morning of D-day.

Discussion: Helicopter availability to U.S. Marines in South Vietnam may be described as "limited" at best; consequently, planning for a helilift must be detailed and thorough. The landing zones are selected in conjunction with the supporting helicopter squadron after a photo study and a detailed reconnaissance. The numbers of lifts needed and the timing of the movement is covered in a detailed briefing of all participants. The success of the landing, particularly if it is opposed, depends upon this detailed planning. On Operation "Thunderbolt" this planning was accomplished. On the morning of D-day ten newspaper correspondents appeared in the loading zone, that had not been expected; Aircraft from a squadron other than the one briefed arrived early in the loading zone and shut down, thereby necessitating the briefed squadron's landing adjacent to the loading zone in an unmarked area. This in addition to a change in the number of aircraft caused confusion in loading. Following a hasty modification to the landing plan the battalion embarked in helicopters, only to be landed in an area 900yards from the previously selected landing zone.

Recommendation: That changes to the Landing Plan be promulgated as soon as they are known so that supporting and supported units have adequate time to modify plans. Last minute changes can be eased by telephone notification of changes after plans have been issued.

Item: There was no close air support or direct artillery support for Battalion (-) withdrawal.

Discussion: Direct support artillery and close air support had been planned to cover the battalion (-) withdrawal. This might be considered an excess of supporting arms but in this operation it was considered necessary. The withdrawal is the crucial phase of a search and destroy operation outside of the FAOR. As the strength of friendly forces diminishes the threat of enemy attack increases and supporting arms must be available in the event of attack. This support was not available to the degree required. Although armed UH-1H helicopters covered the withdrawal, they are not considered to be

close air support in the sense that A-4 and F-4B aircraft are. The battalion discovered that the direct support artillery battery had displaced after the fact. Although the 155mm gun (SP) had the range to cover the battalion, and were in position to do so, these facts were not known by the Battalion FSC.

**Recommendation:** That all supporting arms available be used to cover withdrawals in future operations. That direct support units not be withdrawn without notification to the supported unit. That armed helicopters not be classified as close air support but rather as escort type aircraft.

**Item:** Registration of indirect fire weapons was hampered by helicopter orbiting the battalion defensive position for no apparent reason.

**Discussion:** The battalion arrived in its night defensive area at 061700H. By the time the last of the rations, water and ammunition were in it was about 061900H. This allowed about forty-five (45) minutes for registration of 107mm Howtars and 81mm Mortars. During this period there were two (2) UH-34D and two (2) UH-1E helicopters orbiting the defensive position for no apparent reason. Attempts to communicate with these helicopters failed. Registration had to stop until the aircraft left the area. Consequently, registration was not completed until after dark.

**Recommendation:** That all aircraft in the battalion area be controlled by the supported unit and that the helicopters be responsive to directions from the ground.

#### MEDICAL

**Items:** There were fifty-two (52) heat casualties during the course of the operation.

**Discussion:** The battalion moved forward during the hours 1200-1600 and incurred an inordinately large number of heat casualties. They seemed to occur all at once and for a period of time operations were of necessity suspended to facilitate their evacuation. It was noted that once a Marine became a heat casualty his companions expended their water to cool him off. Once the evacuee has left it was not long before these Marines with empty canteens succumbed to the heat. It is believed that if each helicopter would carry two (2) filled water cans to be dropped at the landing point when picking up a heat casualty, the problem could be materially alleviated. It is also believed that suspending operations during the hottest portion of the day, or conducting the major part of the operation at night, would reduce significantly the number of heat prostrations.

**Recommendations:** That arrangements be made with the helicopter squadron to carry two (2) water cans per aircraft to be unloaded when evacuating a heat casualty.

DECLASSIFIED

These cans could be recovered on the next trip to the area. That consideration be given to operating exclusively at night or at least to suspending operations during the heat of the day.

COMMUNICATIONS

- Item: Six (6) AN/PRC-10's ceased to function during the course of the operation. Three (3) of them were repaired in the field.
- Discussion: The battalion took a radio technician with a small amount of tools to the field and was able to effect repairs of three (3) of six (6) defective radios. The repairs were of a minor nature only, but were effected on the spot. Had the technician not been present the radios would have been evacuated and lost for the operation.
- Recommendation: That a radio technician and a limited number of tools be taken on operations to effect field repair of inoperative radios.
- Item: The Tactical Air Direction net was cluttered with unnecessary traffic.
- Discussion: During the course of the operation several attempts were made to obtain helicopters for heat evacuation. The efforts were hampered by unnecessary traffic on the TAD net. The UH-1E's were talking back and forth almost constantly and a great deal of the conversation was idle chatter.
- Recommendation: That heavily trafficked frequencies be kept clear for necessary transmissions.

LOGISTICS

- Item: The battalion staged a water trailer in the loading zone so as to enable the emplaning Marines to top off their canteens before leaving.
- Discussion: Frequently Marines must walk one or two thousand meters to the loading zone; consequently, there is a drain on the canteens before they ever emplane. If a water trailer is emplaced in the loading zone the Marines may fill their canteens just before they load and be able to commence the operation with a full load of water.
- Recommendation: That commanders consider staging a water trailer in the loading zone for each operation
- Item: There is a necessity for someone to work in battalion rear in order to see to the interests of each company and for resupply during an operation.
- Discussion: The battalion may work the resupply of companies several ways.

DECLASSIFIED

One method that has proven successful has been to use the company property NCO in the battalion rear to supervise the acquisition, staging, and loading of supplies for his company. Once the supplies are loaded aboard the LVT or helicopter, the property NCO accompanies them to their destination and supervises distribution to the platoons. He then takes care of picking up and reloading empty water cans, and the like, for return to base. This system works quite well and relieves the Marines in the field of the routine duties connected with the issuance of communications gear, show water and other supplies.

Recommendation: That unit commanders consider using the aforementioned solution when planning extended field operations.

Item: Lister bags serve a useful purpose when conducting a water resupply mission.

Discussion: The battalion took lister bags out with the full five-gallon water cans to facilitate resupply. These lister bags were collapsed and placed on top of the water cans in the aircraft. When the water cans were unloaded, the lister bag was set up and filled immediately thereby enabling eight (8) Marines to fill their canteens at once with minimum spillage.

Recommendation: Use lister bags in conjunction with water resupply.

Item: There is a need for a means of marking 782 gear to avoid loss when casualties are evacuated.

Discussion: When casualties are heavy the problem of recovering 782 gear and returning it to the proper unit arises. If the gear is marked somehow, the process is facilitated.

Recommendation: That 782 gear, i.e. pack and belt, be tagged with the individuals name and company.

INTELLIGENCE

Item: One interpreter per company is simply not enough to react promptly to situations arising in villages during the conduct of a search and destroy operation.

Discussion: When searching villages and interrogating people, various situations present themselves such as persons volunteering information, suspicious persons who need interrogating, bunkers under houses which have to be checked, etc. Each of these situations require an interpreter to be present. When a company goes through a village the platoons are well dispersed and each of them encounter many of the aforementioned situations. One interpreter per company does not facilitate, but rather hinders, timely reaction to a given incident.

Recommendation: That sufficient interpreters be assigned to provide one per rifle platoon.



DECLASSIFIED

Item: Aerial photographs were used extensively for briefings and study.

Discussion: Aerial photographs of the entire area of operations were obtained and studied at battalion level. They were then made available to commanders of subordinate units. They proved invaluable for briefings at the small unit level. Also aerial photography lessens the necessity for aerial reconnaissance and thereby strengthens security.

Recommendation: That aerial photographs be made available on the basis of two (2) per company prior to all major operations.

Items: There are many discrepancies on the maps we have, i.e. villages shown on the map are not there, hills and reservoirs are not shown on the map, and roads on the map turned out to be trails on the ground.

Recommendation: Maps should be checked carefully against recent aerial photos prior to going on operations in areas outside of the TAOR.

## DECLASSIFIED

UNIT: 3rd Battalion, 3rd Marines  
 PLACE: Chu Lai, Vietnam

OPENED: 010001H Aug65  
 CLOSED: 012400H Aug65

UNIT	TIME	SER NO	DTG	INCIDENTS, MESSAGES, ORDERS
X	0215	1	010215H	LCo patrol 1A has just returned
X	0225	2	010225H	OP #1 rpts VCS tripped flare. 3 illum fired-all duds requesting arty illum
X	0315	3	010315H	ICo ambush patrol back in-negat contact
X	0400	4	010400H	I,L,MCo negative sitrep
X	0600	5	010450H	To MCo-ETA Alligators 010830H. Rendezvous in vicinity of F33
X	0800	6	010800H	Amtracs have left to pick up MCo
X	0825	7	010825H	ICo patrol is at checkpoint #1
X	0840	8	010840H	LCo will be test firing 3.5's and MG's
X	0945	9	010945H	MCo has returned fr peninsula
X	1030	10	011030H	LCo patrol departed area 1000 and reached checkpoint #1 at 1030
X	1030	11	011015H	AG sands-notify roadblock that 2 men (1 Caucasian and 1 Negro) w/M 14's were seen in 1/4 area climb in cream colored veh and head south. Apprehend if seen.
X	1140	12	011140H	ICo patrol has returned-no contact
X	1200	13	011200H	LCo patrol has returned-no contact
X	1210	14	011210H	LCo patrol to rear has just departed
X	1220	15	011220H	KCo negative sitrep
X	1300	16	011300H	KCo 2nd plt patrol is now leaving
X	1415	17	011400H	Wh24 has contact w/friend. He will inform his guide to contact the USMC liaison officer at Binh Son today if possible.
X	1435	18	011435H	KCo 2nd plt patrol has ret to MLR
X	1600	19	011600H	KCo negative sitrep
X	1720	20	011720H	OP #1 rpts grenade thrown at 3 men setting trip flares in front of position. All 3 were evacuated to B.Med. 2 shots fired at VC-blood found, but no bodies
X	2000	21	012000H	I,K,LCo negative sitrep
X	2010	22	012010H	ICo roadblock/checkpoint report
X	2105	23	012105H	KCo 2nd plt patrol has departed
X	2107	24	012107H	LCo 2nd plt patrol has departed
X	2140	25	012140H	KCo 1st plt layout patrol is out
X	2240	26	012240H	KCo 3rd plt patrol has departed
X	2255	27	012255H	LCo patrol 3A (layout) is setting now
X	2400	28	012400H	I,K,LCo negative sitrep

## DECLASSIFIED

UNIT: 3rd Battalion, 3rd Marines  
 PLACE: Chu Lai, Vietnam

OPENED: 020001H Aug65  
 CLOSED: 022400H Aug65

UNIT	TIME	SER NO	DTG	INCIDENTS, MESSAGES, ORDERS
X	0200	29	020200H	All companies negative sitrep
X	0205	30	020205H	ICo patrol now leaving area
X	0315	31	020315H	LCo layout patrol fr 3rd plt has returned
X	0400	32	020400H	ICo 3rd plt layout patrol has returned
X	0400	33	020400H	I,K,LCo negative sitrep
X	0520	34	020520H	ICo ambush patrol back at 0520
X	0630	35	020630H	ICo patrol back at 0600
X	0700	36	020700H	KCo negative sitrep
X	0712	37	020712H	LCo negative sitrep
X	0720	38	020720H	LCo told to cut size of 0900 patrol fr plt to sqd
X	0955	39	020955H	LCo patrol departed at 0900 and reached check point #1 at 0930
X	1145	40	021021H	Wh24 sends-G-3 advisor req Chaplain bring a Wh operational overlay showing LZ and scheme of maneuver.
X	1145	41	021045H	SD24 unable to contact guide. We are calling Quang Ngai to contact Nordquist. Will remain here until contact is made.
X	1145	42	021115H	Unable to contact Quang Ngai. Requests to go to Quang Ngai via road. Advisor says the road is clear.
X	1250	43	021250H	I,K,LCo negative sitrep
X	1340	44	021115H	Wh10 unable to contact Quang Ngai. Requests to go to Quang Ngai on Route #1. Trip takes 20 min one way.
X	1158	45	021145H	To Wh24-where is our guide?
X	1340	46	021320H	In ref to yr 021115H, negative on trip to Quang Ngai via road; wait for further inst
X	1340	47	020341Z	To Wh24-Chaplain and doctor not coming-no choppers aval. Can you send one?
X	1340	48	021250H	In ref to yr 020341Z, negat on helo
X	1425	49	021425H	ICo has landed on peninsula.
X	1435	50	021425H	Wh2 request immed reply to their 021115H
X	1530	51	021520H	Wh24 sends-guide was to meet your party at 021000H in Binh Son. Unable to contact go between. Will keep trying and rpt when successful.
X	1858	52	021858H	ICo request pickup at 620014. Negat results in finding mother of wounded girl
X	2015	53	020630Z	Report of non-battle death (Ferguson)
X	2015	54	021800H	ICo present location is at hill 60
X	2020	55	021950H	ICo roadblock/checkpoint report
X	2020	56	021955H	LCo negative sitrep
X	2020	57	022010H	ICo is at battalion CP
X	2020	58	022015H	Wallet lost within TAOR belonging to PFC Vephdin, Jack W., 2108770
X	2020	59	022020H	LCo patrol 1A departing

DECLASSIFIED

## DECLASSIFIED

UNIT: 3rd Battalion, 3rd Marines  
 PLACE: Chu Lai, Vietnam

OPENED: 020001H Aug65  
 CLOSED: 022400H Aug65

UNIT	TIME	SER NO	DTG	INCIDENTS, MESSAGES, ORDERS
X	2050	60	022044H	Sparrow sighted 2 men w/rifles and 1 woman at 1832H at 624986 heading east. Our present position 63.4,99.7
X	2050	61	022011H	To KCo-tell arty FO that transportation will be in their area around 1300
X	2050	62	022038H	Catbird has arrived at objective
X	2050	63	022040H	Blue Jay position is right 2, down 8
X	2050	64	022048H	Cardinal position is right 1.5, down .5
X	2220	65	021315Z	TS sends-all liaison officers are required to check in at 0400, 0800, 1200, 1600, 2000, and 2400
X	2400	66	022400H	All companies negative sitrep

DECLASSIFIED

## DECLASSIFIED

UNIT: 3rd Battalion, 3rd Marines  
 PLACE: Chu Lai, Vietnam

OPENED: 030001H Aug65  
 CLOSED: 032400H Aug65

UNIT	TIME	SER NO	DTG	INCIDENTS, MESSAGES, ORDERS
X	0200	67	030200H	MCo 2nd patrol left at 0200
X	0210	68	030210H	ICo patrol left at 0130
X	0410	69	030410H	I,L,MCo negative sitrep
X	0535	70	030535H	MCo vehicle w/3 men is coming down the beach towards the CP
X	0645	71	030645H	ICo negative sitrep
X	0750	72	030750H	Wh34 sends-3 women were picked up while farming vicinity 565039. 1 man with them took off running
X	0855	73	030855H	To SD24-We will deliver 6 PF's to Binh Son at 1100H on 3Aug65. We would like to pick up 6 more at this time
X	1015	74	030950H	In ref to yr 030855H, affirmative.
X	1140	75	031140H	MCo has apprehended 1 VCS at BT 567018
X	1346	76	031322H	SD24 sends-PF plt rpts VC ordered populus living in vicinity of roadblock to dig foxholes and tunnels for protection in the event VC attack roadblock. Dist Chief says they will conduct at least minor action for propaganda
X	1840	77	031815H	Catbird rpts 23 men w/weapons mixed clothing moving north. Req pickup at 615002 at 1930. Heavy enemy activity in area
X	1840	78	031840H	Wh24 sends-guide departed Quang Ngai w/letter fr go between to Capt Raleigh
X	1840	79	031840H	4 LVT's left CP to pick up Catbird at 623003
X	1855	80	031855H	Catbird requests helo evac immed. Surrounded by 23 VC
X	1910	81	031910H	Choppers to stand by at CP
X	1915	82	031915H	Amtrac broken down-sending another
X	1955	83	031955H	Catbird rpts 4 men w/weapons moving north at 1706. Coord same as ours.
X	2000	84	032000H	ICo roadblock/checkpoint report
X	2000	85	032000H	I,L,MCo negative sitrep
X	2015	86	032015H	Cardinal requires pick up at previous coordinates
X	2045	87	032045H	MCo rpts all people not back-2 Amtracs broke down. Will call when they return
X	2105	88	032105H	MCo all back
X	2215	89	032215H	ICo OP #1 spotted 1 figure. Threw one flare and figure dropped and took off running when flare went out

DECLASSIFIED

## DECLASSIFIED

UNIT: 3rd Battalion, 3rd Marines  
 PLACE: Chu Lai, Vietnam

OPENED: 040001H Aug65  
 CLOSED: 042400H Aug65

UNIT	TIME	SER NO	DTG	INCIDENTS, MESSAGES, ORDERS
X	0120	90	040120H	ICo rpts illum fired over 1st plt. No contact as yet
X	0206	91	040206H	Cardinal negative sitrep
X	0220	92	040220H	3rd patrol just returned-negative results
X	0350	93	040350H	I,L,MCo negative sitrep
X	0425	94	040425H	LCo rpts flare to right rear around 4thMar
X	0456	95	040456H	LCo rpts another flare to right rear
X	0715	96	040715H	LCo patrol is now leaving.
X	0750	97	040750H	ICo daylight patrol left at approx 0630.
X	1135	98	040925H	SD24 sends-District informer says VC Co commanded by Pham Lua rpt at Phu Le has mines & plastic explosives which they plan to use on marine vehicles in near future
X	1230	99	041200H	TS sends-VC Co previously located 566938 has mines & expl to use on USMC vehicles traveling route #1 (See above msg)
X	1230	100	040234Z	Wh24 sends-Info received fr Ly Tin indicates 4 Caucasian & 2 Negro POW's seen
X	1545	101	040545Z	TS sends to Rivermud 62-I have bought a pumpkin
X	1610	102	041610H	I,L,MCo negative sitrep
X	2000	103	042000H	ICo roadblock/checkpoint count
X	2000	104	042000H	I,L,MCo negative sitrep

DECLASSIFIED

## DECLASSIFIED

UNIT: 3rd Battalion, 3rd Marines  
 PLACE: Chu Lai, Vietnam

OPENED: 050001H Aug65  
 CLOSED: 052400H Aug65

UNIT	TIME	SER NO	DTG	INCIDENTS, MESSAGES, ORDERS
X	0005	105	050005H	I,L,MCo negative sitrep
X	0315	106	050315H	ICo recon patrol has ret-negat results
X	0350	107	050350H	LCo patrol 1A has returned
X	0400	108	050400H	MCo all secure - no contact
X	0400	109	050400H	I,LCo negative sitrep
X	0905	110	050900H	To SD24-request you check with Capt Long and see if we can pick up 1 Co for oper
X	1145	111	051108H	Wh24 requests ETA of FO's and FAC's
X	1145	112	051105H	Wh24 sends-1 sqd of VC harassing traffic at BS 585945. VC led demonstrations at BT 590930
X	1245	113	051245H	I,L,MCo negative sitrep
X	1355	114	051355H	Wh6 is now at B Med
X	1600	115	051600H	I,L,MCo negative sitrep
X	1710	116	051656H	Wh24 requests permission to fire Binh Son arty on coord BS 694948
X	1915	117	051915H	OP #1 rpts 3-4 rds of small arms fire vic coord 555002-not directed at them
X	1925	118	051925H	ICo rpts tank at OP #1 (searchlight)
X	1930	119	051930H	Sw35 rpts vehicle broke down between Bn CP and LCo. Vehicle sent to bring it in.
X	1940	120	051940H	To AG3-arty called in on peninsula at VCS unloading boat. 36 rds had good effect
X	1946	121	051946H	I,L,MCo negative sitrep
X	1950	122	051950H	ICo roadblock/checkpoint report
X	1951	123	051951H	L,MCo report small arms fire at mouth of river
X	2050	124	052050H	LCo has occupied OP #1
X	2205	125	052205H	I,L,MCo rpt firing and red flares to ft front of MCo at 4000m. OP #1 rpt fire fight at PF roadblock coord 565997
X	2235	126	052235H	MCo rpts movement 150m to rt of OP #3
X	2250	127	052250H	LCo rpts increase in small arms firing heard earlier
X	2335	128	052335H	MCo negative sitrep

DECLASSIFIED

## DECLASSIFIED

UNIT: 3rd Battalion, 3rd Marines

OPENED: 060001H Aug65

PLACE: Chu Lai, Vietnam

CLOSED: 062400H Aug65

I O

N. U T	TIME	SER NO	DTG	INCIDENTS, MESSAGES, ORDERS
X	0040	129	060040H	LCo 1st plt spotted red star parachute.
X	0055	130	060055H	ICo rpts red star parachute fired by PF's SD24 rpts 2 plt ambush at BS575970 to BS591937 to keep road clear until 0700H
X	0420	131	060420H	I,L,MCo negative sitrep
X	0420	132	060420H	Convoy of 12 6x6's, 3 ontos and 2 tks coming from Regt CP at 0430
X	0630	133	060630H	Wh19 requests Father Paquette be informed that he is unable to arrange transportation
X	0730	134	060730H	Father Paquette will be in Saigon on 10 Aug
X	0805	135	060805H	VC unit locations fr 51st ARVN
X	1435	136	061220H	1045H posit ARVN 3rd Marines coord 525880 3/51 coord 558873
X	1547	137	061545H	Resupply will go as scheduled. Request 5 men fr ea Co act as guides and assist in unloading helicopters
X	1710	138	061700H	G3 requests to know the total number of helicopters used on operation
X	1805	139	061750H	Wh (Fwd) will send VC documents and cloth- ing found at 557858 by ICo; also mine found by LCo
X	1818	140	061813H	TS6 requests situation regarding completing lifting of Howtars. Tinge will not release till Wh6 req them
X	2045	141	062000H	Wh (Fwd) rpts automatic small arms fire 2000m to their rear
X	2010	142	062010H	LCo negative sitrep
X	2037	143	062025H	Wh4 request staging of empty water cans, enr tools lister bags etc for pickup at time of morning water resupply
X	2355	144	062355H	L.MCo negative sitrep

DECLASSIFIED



## DECLASSIFIED

UNIT: 3rd Battalion, 3rd Marines  
 PLACE: Chu Lai, Vietnam

OPENED: 070001H Aug65  
 CLOSED: 072400H Aug65

I O N U T	TIME	SER NO	DTG	INCIDENTS, MESSAGES, ORDERS
X	0030	145	070030H	Wh negative sitrep
X	0100	146	070100H	Wh negative sitrep
X	0130	147	070130H	Wh negative sitrep
X	0200	148	070200H	Wh negative sitrep
X	0400	149	070400H	Wh negative sitrep
X	0400	150	070400H	Binh Son receiving small arms fire
X	0650	151	070650H	Wh will move to PL Charlie as soon as How- tars are lifted out
X	0735	152	070716H	Do not send out yesie day's heat casualties
X	1100	153	070955H	0730 sitrep-all units departed PL Bravo for PL Charlie; negat enemy contact
X	1123	154	071057H	Wh24 rpts Side Saddle 86B ret to our location. ETA unknown
X	1215	155	071119H	Wh24 requests final no. of friendly and enemy casualties, no. of POW's and captured weapons
X	1250	156	071230H	Wh6 rpts ETA at LZ Low 071345H-request transportation
X	1315	157	071235H	Wh24 requests helo pick up of IO's and FAC at 071600H-total of 8 men
X	1520	158	071455H	Wh24 requests no. of helos use on oper
X	1610	159	071610H	I,L,MCo negative sitrep
X	2000	160	071734H	In ref to yr 071119H, 2 friendly WIA, 1 VC dead, 2 VCC and 1 VCS. 2 carbines captured and sent to Da Nang
X	2340	161	072340H	LCo patrol back in - negative contact
X	2350	162	072350H	I,MCo negative sitrep
X	2350	163	072350H	I,L,MCo negative sitrep

DECLASSIFIED

## DECLASSIFIED

UNIT: 3rd Battalion, 3rd Marines  
 PLACE: Chu Lai, Vietnam

OPENED: 080001H Aug65  
 CLOSED: 082400H Aug65

UNIT	TIME	SER NO	DTG	INCIDENTS, MESSAGES, ORDERS
X	0030	164	080030H	Wh negative sitrep to AG
X	0210	165	080210H	ICo rpts flare to their rear
X	0400	166	080400H	I, MCo negative sitrep
X	0500	167	080500H	ICo rpts 2 flares in Bendix area
X	0630	168	080630H	ICo Alpha patrol has departed
X	0805	169	080805H	I, L, MCo negative sitrep
X	0810	170	080810H	H&SCo patrol has departed
X	0945	171	080945H	ICo patrol has returned
X	1055	172	080250Z	Alert roadblocks to be on alert for mite w/o tactical markings. No of vehicle is either 308365 or 308395. Occupants 1 Cpl & 1 Cpl (TS rpt apprehension at 1100H)
X	1115	173	081115H	ICo OP #1 rec'd 1 incoming rd coord 564003
X	1200	174	081200H	I, L, MCo negative sitrep
X	1400	175	081400H	MCo patrol departed at 0900
X	1405	176	081405H	H&SCo patrol returned at 0935
X	1425	177	081425H	MCo patrol returned at 1045
X	1426	178	081426H	SD24 rpts sqd of VC harrassing traffic on route 1
X	1600	179	081600H	I, L, MCo negative sitrep
X	1945	180	081945H	ICo roadblock/checkpoint report
X	1950	181	081950H	LCo rpts situation the same-all quiet
X	1953	182	081953H	MCo 1st plt patrol is now leaving. Negative sitrep
X	1955	183	081958H	OP #1 fired 1 flare at suspected movement to the front-negative results
X	2050	184	082050H	MCo patrol departed
X	2325	185	082325H	MCo 1st plt observed light to right of posit and then heard shot go off
X	2330	186	082330H	ICo roadblock rpts one man moving up railroad who ran when challenged. Fired one shot-results being checked
X	2355	187	082355H	MCo and LCo negative sitrep

DECLASSIFIED

## DECLASSIFIED

UNIT: 3rd Battalion, 3rd Marines  
 PLACE: Chu Lai, Vietnam

OPENED: 090001H Aug65  
 CLOSED: 092400H Aug65

I O N U T	TIME	SER NO	DTG	INCIDENTS, MESSAGES, ORDERS
X	0100	188	090100H	LCo patrol has departed
X	0245	189	090245H	ICo patrol has departed fr OP #1
X	0246	190	090246H	LCo patrol is at checkpoint #1
X	0300	191	090300H	MCo patrol has departed
X	0400	192	090400H	I, L, MCo negative sitrep
X	0505	193	090505H	ICo rpts flare to front of LCo lines
X	0510	194	090510H	ICo rpts another flare to the front of LCo lines
X	0515	195	090515H	ICo reports 2 flares to left of OP #1
X	0520	196	090520H	Mike 3 has tried twice to contact OP #3 without success
X	0625	197	090625H	MCo layout patrol reported in with no contact
X	0730	198	090730H	Devastate 14 will be conducting bombing at 1300H coord BS 554874
X	0800	199	090800H	All companies rpt negative sitrep
X	0801	200	090801H	LCo Bravo patrol has returned
X	0830	201	090830H	MCo alpha patrol has departed
X	0916	202	090916H	H&S patrol at checkpoint #3
X	0940	203	090940H	MCo alpha at checkpoint #1
X	0945	204	090945H	Bn Medical Officer departed for I, L, MCo
X	1000	205	091000H	H&S patrol has returned
X	1035	206	091035H	MCo patrol at checkpoint #2
X	1155	207	091155H	MCo patrol at checkpoint #3
X	1200	208	091200H	All companies rpt negative sitreps
X	1212	209	091212H	MCo alpha patrol has returned. Found one drum of 91 fuel
X	1600	210	091600H	All companies rpt negative sitrep
X	1945	211	091945H	ICo roadblock/checkpoint report
X	2000	212	092000H	All companies rpt negative sitrep
X	2030	213	092030H	AG rpts Bendix firing at 2 men moving towards 3/3 CP area
X	2252	214	092252H	OP #1 rec'd 14-15 rds of small arms fire at 2245 - no casualties
X	2315	215	092315H	ICo rpts shooting at 3 men after illum, also rpts continuous movement So of ARVN positions
X	2400	216	092400H	Negative sitrep submitted to AG

DECLASSIFIED

## DECLASSIFIED

UNIT: 3rd Battalion, 3rd Marines  
 PLACE: Chu Lai, Vietnam

OPENED: 100001H Aug65  
 CLOSED: 102400H Aug65

UNIT	TIME	SER NO	DTG	INCIDENTS, MESSAGES, ORDERS
X	0017	217	100017H	MCo patrol departed at 0017
X	0110	218	100110H	MCo patrol at checkpoint #1
X	0240	219	100240H	MCo rpt small arms fire in front of their position estimated to be near river
X	0245	220	100245H	3 tks and 3 LVT's moving down beach to the south in diversionary action (To AG3)
X	0350	221	100350H	Tks have returned with negative results
X	0400	222	100400H	I,L,MCo negative sitrep
X	0800	223	100800H	I,L,MCo negative sitrep
X	0922	224	100815H	TS sends-only emergency vehicles will be allowed on MCR by air strip between 1015H and 1145H
X	0930	225	100925H	Wh24 rpts 2 PF plts engaged VC at BS 610955. 2 PF KIA and 3 WIA. VC losses unknown
X	0932	226	100926H	Wh24 sends-G/3 arty advisor wishes to know unit designators and number of arty at Chu Lai
X	0935	227	100935H	H&S patrol has returned to area
X	0945	228	100945H	MCo patrol has departed
X	1200	229	101200H	I,L,MCo negative sitrep
X	1205	230	101205H	MCo patrol has returned
X	1545	231	101545H	LCo negative sitrep
X	2000	232	102000H	I,L,MCo negative sitrep
X	2135	233	102135H	MCo plt size patrol left at 2100
X	2135	234	102135H	MCo sqd size patrol left at 2100
X	2310	235	102310H	MCo plt patrol at checkpoint #1
X	2315	236	102315H	LCo plt patrol has departed
X	2330	237	102330H	MCo sqd size patrol reported in with no contact
X	2400	238	102400H	All companies report negative sitreps

DECLASSIFIED

DECLASSIFIED

UNIT: 3rd Battalion, 3rd Marines  
 PLACE: Ghu Lai, Vietnam

OPENED: 110001H Aug65  
 CLOSED: 112400H Aug65

TIME	SER NO.	DTG	INCIDENTS, AGES, ORDERS
X 0110	239	110110H	LCo has lost contact w/patrol #1
X 0215	240	110215H	MCo patrol has ret-negat contact
X 0400	241	110400H	1 fire team & 1 sqd departed on patrol
X 0400	242	110400H	I,L,MCo negative sitrep
X 0445	243	110445H	LCo fireteam layout has ret - Ambush patrol is ret
X 0520	244	110520H	ICo rpts 81 illum to rt rear in 2/4 area
X 0525	245	110525H	LCo #1 patrol has ret. Neg contact
X 0533	246	110533H	MCo patrol has ret - no contact
X 0735	247	110735H	ICo boarding LVT's and moving out
X 0740	248	110740H	MCo patrol has departed
X 0743	249	110743H	ICo has left CP
X 0800	250	110800H	I,L,MCo negative sitrep
X 0845	251	110845H	ICo has landed on the beach
X 0930	252	110930H	ICo at 625025
X 1030	253	111030H	ICo receiving small arms fire fr 665005
X 1100	254	111100H	ICo found 8" dud at 650005
X 1120	255	111120H	ICo receiving fire fr 655002
X 1200	256	111200H	L,MCo negative sitrep
X 1230	257	111230H	ICo req arty support at 664981 & 664987
X 1231	258	111231H	LCo patrol Bravo has departed
X 1238	259	111238H	Arty is now on the way (for ICo)
X 1307	260	111307H	MCo patrol 3A returned at 1110H
X 1400	261	111150H	SD24 req to know ETR of 6 PF's due back 10Aug. Dist chief very concerned 10 Aug 65
X 1410	262	111410H	ICo at 660990 searching village
X 1445	263	111445H	ICo on the way to ckpt 7.
X 1515	264	111515H	LCo B patrol at ckpt #1
X 1530	265	111530H	ICo blow caves at 657999
X 1550	266	111550H	ICo rec'd sniper fire fr 641999.
X 1600	267	111600H	L,MCo negative sitrep patrol on patrol
X 1605	268	110605Z	Wh2, and new 24 will leave CP at 0830 tomorrow for yr posit. (To Wh24) ambush
X 1615	269	111615H	LCo patrol Bravo at ckpt #2
X 1620	270	111620H	ICo at 645005 chasing 10 VC; 2 are wounded
X 1627	271	111627H	arty mission fired for ICo at 623004
X 1645	272	111645H	ICo receiving mortar fire fr Tan Hy (2) at 630992. Also receiving small arms fire from 635995
X 1712	273	110600Z	Wh2 prefers to exchange 6 PF's on 12Aug. 2 are on Co oper and 2 at roadblock presently (To SD24)
X 1740	274	111740H	LCo patrol has returned to area
X 1812	275	111812H	ICo patrols 1 and 2 are at ckpts #9:5005
X 1935	276	111935H	ICo located at 628996
X 1945	277	111945H	ICo directed to obtain crater analysis of incoming 60mm mortar rds and bring back fragments 664987
X 2005	278	112005H	I,L,MCo negative sitrep
X 2020	279	112020H	ICo sitrep-all quiet at this time
X 2045	280	112045H	MCo layouts 1 and 2 have left
X 2400	281	112400H	I,L,MCo negative sitrep

DECLASSIFIED

## DECLASSIFIED

UNIT: 3rd Battalion, 3rd Marines  
 PLACE: Chu Lai, Vietnam

OPENED: 120001H Aug65  
 CLOSED: 122400H Aug65

UNIT	TIME	SER NO	DTG	INCIDENTS, MESSAGES, ORDERS
X	0110	282	120110H	ICo patrol 1 is moving to ckpt 11
X	0155	283	120155H	MCo patrol 3 is at ckpt #1
X	0200	284	120200H	ICo patrol 2 is moving to ckpt 10
X	0400	285	120400H	MCo negative contact - all quiet
X	0410	286	120410H	LCo situation remains the same-no contact
X	0440	287	120105H	SD24 rpts that 10Aug 1 VC district force at BS 688886 w/tunnels-comdr is Huynh Trach. 1 plt fm this Co is active at BS 688857 at 1700 ea day
X	0615	288	120615H	ICo moving to secure crater analysis and also mov ng to secure LZ
X	0630	289	120630H	ICo moving toward hill 60, India 2 firing in vicinity of 613985
		290		MCo patrol #1 returned - no contact
Y	0640	291	120640H	To ICo - Tarbush delayed for 1 hour
X	0730	292	120730H	MCo patrol ret at 0715-no contact
X	0731	293	120731H	ICo located at 637997
X	0945	294	120945H	ICo has returned to MLR
X	1445	295	121445H	LCo patrol departed at 1000, reached ckpt 1,2,3 at 1030,1100,1200 respectively, and ret at 1410. No contact
X	1615	296	121615H	I,L,MCo negative sitrep
X	1830	297	121830H	LCo 2nd plt patrol is out
X	1900	298	121900H	LCo patrol at ckpt 1
X	1930	299	121930H	LCo patrol at ckpt 2
X	1945	300	121945H	ICo roadblock/checkpoint report
X	2000	301	122000H	LCo patrol at ckpt 3
X	2000	302	122000H	I,L,MCo negative sitrep
X	2105	303	122105H	MCo 1st layout patrol has departed
X	2115	304	122115H	LCo patrol has departed
X	2230	305	122215H	LCo fired 2 M 79 rds
X	2230	306	122223H	ICo rpts a flare over LCo lines
X	2230	307	122230H	MCo plt ambush #1 departed
X	2240	308	122240H	LCo sqd patrol Bravo at ckpt #1
X	2335	309	122335H	MCo sqd layout patrol has returned
X	2355	310	122355H	I,L,MCo negative sitrep

DECLASSIFIED

## DECLASSIFIED

UNIT: 3rd Battalion, 3rd Marines  
 PLACE: Chu Lai, Vietnam

OPENED: 130001H Aug65  
 CLOSED: 132400H Aug65

UNIT	TIME	SEQ. NO	DTG	INCIDENTS, MESSAGES, ORDERS
X	0007	311	130007H	MCo layout patrol 3 departed
X	0017	312	130017H	LCo layout patrol 1 returned
X	0020	313	130020H	LCo layout patrol 2 returned
X	0030	314	130030H	MCo ambush patrol #1 at ckpt 2
X	0110	315	130110H	ICo ambush patrol #1 departed
X	0225	316	130225H	ICo patrol charlie departed
X	0328	317	130328H	MCo patrol 3 returned-no contact
X	0400	318	130400H	I,L,MCo negative sitrep
X	0528	319	130528H	ICo patrol charlie returned
X	0605	320	130605H	MCo plt ambush patrol 1 returned
X	0625	321	130625H	ICo patrol alpha has returned
X	0640	322	130640H	Negative sitrep to Ag3
X	0645	323	130645H	ICo patrol departed
X	0720	324	130720H	H&S patrol at ckpt 1
X	0800	325	130800H	MCo rpts approx 100 Vietnamese in front of their positions. MCo5 and interpreter are investigating
X	0815	326	130815H	H&S patrol at ckpt 2
X	0950	327	130950H	Tango now entering the CP area
X	1035	328	131035H	LCo patrol departed Co area
X	1135	329	131135H	ICo patrol has returned to Co area
X	1200	330	131200H	I,L,MCo negative sitrep
X	1310	331	131310H	LCo entering My Hue 1 and questioning one suspect
X	1330	332	131330H	MCo patrol departed
X	1410	333	131410H	MCo patrol returned - no contact
X	1600	334	131600H	I,L,MCo negative sitrep
X	1630	335	131630H	LCo patrol alpha returned
X	1950	336	131950H	ICo roadblock/checkpoint report
X	2008	337	132008H	I,L,MCo negative sitrep
X	2025	338	132025H	MCo patrol 3 departed
X	2030	339	132030H	LCo patrol charlie departed
X	2125	340	132125H	MCo patrol 3 alpha at ckpt 1
X	2125	341	132125H	LCo patrol bravo departed
X	2137	342	132137H	MCo rpts periodic rifle firing to front in area of peninsula, also OP #3 rpts hearing M 79's and seeing flares on peninsula
X	2225	343	132225H	AG3 sends-ARVN Arty firing coord BS 630948
X	2300	344	132300H	LCo patrol bravo has returned
X	2350	345	132350H	MCo patrol 3 has returned
X	2400	346	132400H	I,L,MCo negative sitrep

DECLASSIFIED

## DECLASSIFIED

UNIT: 3rd Battalion, 3rd Marines  
 PLACE: Chu Lai, Vietnam

OPENED: 140001H Aug65  
 CLOSED: 142400H Aug65

UNIT	TIME	SER NO	DTG	INCIDENTS, MESSAGES, ORDERS
X	0001	347	140001H	ICo patrol charlie departed
X	0045	348	140045H	OP #3 rpts approx 15 pers in front of their posit moving west. Drums & torches heard & seen in the distance.
X	0100	349	140100H	OP #3 requested 81 illum at 589019 - granted (Rd fell 200 yds short at max range)
X	0105	350	140105H	ICo patrol alpha is now departing
X	0150	351	140150H	ICo patrol charlie at ckpt 1
X	0405	352	140400H	I,L,MCo negative sitrep
X	0640	353	140640H	ICo patrol charlie has returned-no contact
X	0641	354	140641H	ICo patrol bravo departed
X	0730	355	140730H	ICo patrol bravo at ckpt 1
X	0731	356	140731H	ICo patrol delta returned - no contact
X	0805	357	140805H	MCo sitrep-negat contact, all secure
X	0825	358	140825H	ARVN convoy due to leave Tam Ky at 150400H
X	0825	359	140825H	ICo patrol bravo at ckpt 2
X	0837	360	140837H	MCo boarding helicopters for lift to Trung Phan peninsula
X	0855	361	140855H	10 VC w/p cks and weapons on hill at 650004. MCo taking them under fire
X	0900	362	140900H	MCo rpts activity to west. Permission granted to pursue
X	0920	363	140920H	Arty fire mission complete-good effect on target
X	0930	364	140930H	MCo receiving fire. Co is mv fr Dong Le 1
X	0937	365	140937H	MCo rpts 2 WIA's at 666986 in LZ
X	0940	366	140940H	ICo patrol bravo at ckpt 3
X	0951	367	140951H	Med evac helo is on the way
X	1000	368	141000H	MCo has two non-battles vice WIA's (See 365)
X	1010	369	141010H	MCo plan for resupply at 1200 is forward 35 left 30
X	1035	370	141035H	ICo patrol bravo at ckpt 4
X	1045	371	141032H	MCo req 20 rds of HE light for 81's
X	1045	372	141035H	MCo req bolt assembly for M 60 and 1 PRC 10 for 81 FO
X	1045	373	141036H	MCo req 1 rkt launcher and 8 rds HEAT
X	1130	374	141118H	MCo presently at 650005 and 657000. Have lost contact w/VC
X	1150	375	141150H	ICo patrol bravo at ckpt 6
X	1155	376	141155H	MCo found large mock-up map. Took pictures and destroyed map.
X	1200	377	141200H	I,LCo negative sitrep
X	1208	378	141208H	MCo found 1 50 cal link, 80 rds of 30 cal ammo, and one bundle of clothes at 650005 Also found one pack with notebook and clothes
X	1300	379	141300H	MCo observed 3 VC w/wpns at 666996. Arty has been requested and fired

DECLASSIFIED



## DECLASSIFIED

UNIT: 3rd Battalion, 3rd Marines  
 PLACE: Chu Lai, Vietnam

OPENED: 140001H Aug65  
 CLOSED: 142400H Aug65

UNIT	TIME	SER NO	BTG	INCIDENTS, MESSAGES, ORDERS
X	1307	380	141307H	ICo patrol bravo has returned-no contact
X	1315	381	141315H	Arty mission req on 664984-susp mortar position
X	1320	382	141320H	MCo rpts 1 VC dead at 655999. 1 rkt launcher (Chicom) and two hand grenades (Chicom) found
X	1405	383	141356H	One VC dead at 654001. Collected equipment. Had no rifle
X	1420	384	141420H	LCo patrol bravo departed at 1300
X	1421	385	141421H	LCo patrol bravo at ckpt 1 at 1415
X	1540	386	141540H	MCo retraction will be as scheduled. FAC team will be on first chopper
X	1559	387	141559H	LCo patrol bravo at ckpt 3
X	1600	388	141600H	I, LCo negative sitrep
X	1625	389	141625H	LCo 3rd plt patrol ret to position
X	1745	390	141745H	MCo bringing in 8 VCS by chopper
X	1830	391	141830H	MCo bringing in a total of 12 VCS
X	1835	392	141835H	Body of Vietnamese boy being ret to LZ
X	2005	393	142005H	LCo patrol charlie has departed
X	2020	394	142020H	ICo roadblock/checkpoint report
X	2210	395	142210H	LCo patrol charlie is back
X	2220	396	142220H	1 rd of carbine fire rec'd on left flank of CP-fire from south
X	2220	397	142220H	Charlie btry <del>rpt</del> receiving sniper fire
X	2330	398	142330H	MCo posit forward 25 left 33
X	2355	399	142355H	Neg tive sitrep to Afterglow 3

DECLASSIFIED

## DECLASSIFIED

UNIT: 3rd Battalion, 3rd Marines  
 PLACE: Chu Lai, Vietnam

OPENED: 150001H Aug65  
 CLOSED: 152400H Aug65

UNIT	TIME	SER NO	DTG	INCIDENTS, MESSAGES, ORDERS
X	0001	400	150001H	I,L,MCo negative sitrep
X	0030	401	150030H	MCo negative sitrep
X	0100	402	150100H	MCo negative sitrep
X	0130	403	150130H	MCo negative sitrep
X	0200	404	150200H	MCo negative sitrep
X	0203	405	150203H	ICo patrol alpha departed
X	0330	406	150330H	MCo negative sitrep
X	0331	407	150331H	LCo 2 alpha departed
X	0400	408	150400H	I,L,MCo negative sitrep
X	0430	409	150430H	Negative sitrep by MCo
X	0435	410	150435H	ICo patrol echo departed
X	0500	411	150500H	MCo negative sitrep
X	0515	412	150515H	LCo patrol alpha has reached ckpt 1
X	0530	413	150530H	MCo negative sitrep
X	0531	414	150531H	LCo patrol is at ckpt 2
X	0655	415	150655H	LCo patrol alpha has returned-no contact
X	0730	416	150730H	H&S patrol departed
X	0750	417	150750H	ICo completed sweep of village-neg results
X	0810	418	150810H	H&S patrol at ckpt 1
X	0811	419	150811H	LCo negative sitrep
X	0906	420	150906H	H&S patrol at ckpt 2
X	0907	421	150907H	ICo back in position
X	0920	422	150920H	H&S patrol has ret. negat contact
X	1207	423	151207H	I,LCo negative sitrep
X	1325	424	151325H	MCo has completed retraction fr peninsula
X	1340	425	151340H	LCo patrol departed
X	1430	426	151430H	LCo patrol 1 at ckpt 1
X	1510	427	151510H	LCo patrol 1 at ckpt 2
X	1600	428	151600H	LCo patrol 1 at ckpt 3; negative sitrep
X	1730	429	151730H	LCo patrol has returned; neg contact
X	1850	430	151850H	LCo patrol bravo 1 is out
X	2000	431	152000H	ICo roadblock/checkpoint report
X	2010	432	152010H	I,L,MCo negative sitrep
X	2018	433	152018H	Wh2 patrol departed area at 2015
X	2035	434	152035H	MCo patrol 3 departed area
X	2115	435	152115H	MCo patrol 1 has departed area
X	2205	436	152205H	MCo patrol 4 at ckpt 1
X	2208	437	152208H	LCo patrol alpha is now leaving
X	2250	438	152250H	LCo fired at 2 men at 568013 and rec'd return fire
X	2310	439	152310H	Sharpshooter alpha 3 rec'd 1 rd on return
X	2312	440	152230H	Late entry-Sharpshooter alpha 3 is leaving CP.
X	2350	441	152350H	MCo patrol 3 returned-negative contact
X	2400	442	152400H	I,L,MCo negative sitrep

DECLASSIFIED

## DECLASSIFIED

UNIT: 3rd Battalion, 3rd Marines  
 PLACE: Chu Lai, Vietnam

OPENED: 160001H Aug65  
 CLOSED: 162400H Aug65

IO N U T	TIME	SER NO	DTG	INCIDENTS, MESSAGES, ORDERS
X	0020	443	160020H	LCo patrol alpha has returned
X	0036	444	160036H	MCo plt patrol reached ckpt #2
X	0045	445	160045H	MCo sqd patrol returned - neg contact
X	0112	446	160112H	LCo patrol bravo 1 returned
X	0145	447	160145H	ICo sqd ambush is departing
X	0320	448	160320H	ICo 2nd sqd 1st plt rec'd 1 grenade at coord 549013
X	0400	449	160400H	I,L,MCo negative sitrep
X	0440	450	160440H	ICo patrol alpha departed at 0130 and returned at 0425
X	0630	451	160630H	ICo patrol bravo departed
X	0655	452	160655H	ICo patrol charlie returned
X	0800	453	160800H	I,L,MCo negative sitrep
X	0910	454	160910H	LCo patrol alpha departed
X	0935	455	160935H	Wh24 sends there will be 4 ARVN tks in our TAOR at 161500H. Direction of travel is north to south
X	0952	456	160952H	Unusually large no. of civilians reported on route 1
X	1110	457	161110H	ICo patrol bravo returned
X	1145	458	161145H	MCo patrol bravo departed
X	1200	459	161200H	LCo patrol alpha returned
X	1201	460	161201H	LCo patrol 1 alpha departed
X	1205	461	161205H	I,L,MCo negative sitrep
X	1245	462	161245H	MCo patrol delta at ckpt 1
X	1320	463	161320H	MCo 2nd plt patrol at ckpt 2
X	1340	464	161340H	LCo patrol at ckpt 1
X	1440	465	161440H	MCo patrol delta at ckpt 2
X	1445	466	161445H	MCo patrol returned
X	1450	467	161450H	LCo patrol at ckpt 3
X	1540	468	161540H	LCo patrol returned
X	1610	469	161610H	I,L,MCo negative sitrep
X	1935	470	161935H	LCo patrol charlie departed
X	1955	471	161955H	I,L,MCo negative sitrep
X	1955	472	161955H	ICo roadblock/checkpoint report
X	2055	473	162055H	LCo patrol charlie at ckpt 1
X	2400	474	162400H	I,L,MCo negative sitrep

DECLASSIFIED

## DECLASSIFIED

UNIT: 3rd Battalion, 3rd Marines  
 PLACE: Chu Lai, Viet Nam

OPENED: 170001H Aug65  
 CLOSED: 172400H Aug65

IO N U T	TIME	SER NO	DTG	INCIDENTS, MESSAGES, ORDERS
X	0023	475	170023H	MCo patrol departed
X	0035	476	170035H	ICo patrol departed
X	0045	477	170045H	LCo patrol departed
X	0125	478	170125H	ICo patrol charlie at ckpt 2
X	0145	479	170145H	ICo patrol alpha departed
X	0200	480	170200H	MCo squad ambush 3rd platoon
X	0340	481	170340H	MCo 3rd patrol returned
X	0400	482	170400H	MCo 2nd platoon patrol returned (Neg)
X	0400	483	170400H	I, L, MCo negative sitrep
X	0630	484	170630H	ICo patrol alpha returned (Neg)
X	0830	485	170830H	I, L, MCo negative sitrep
X	0950	486	170950H	MCo relieved by ACo
X	1010	487	171010H	MCo departing for operation area
X	1100	488	171100H	MCo on the beach
X	1127	489	171127H	MCo now searching village of TUYET DIEM #2 vic coord (BT 645025)
X	1230	490	171230H	MCo requested arty fire sus enemy pos
X	1435	491	171435H	ICo boarded LVTS
X	1357	492	171357H	MCo pres loc Fwd 25 L 10 to Fwd 31 L 2
X	1438	493	171438H	MCo pres loc 677988 records 2 sniper rds entire area appears deserted M-1 Booby Trap
X	1616	494	171616H	WH6 requests PFC WARD return to causeway
X	1618	495	171618H	MCo repts present pos RWD 16 RT 17
X	1734	496	171734H	WH6 requests complete rosters of each compan at causeway by 1800
X	1751	497	171751H	LCo now boarding LCM for ship
X	1945	498	171945H	WH6 aboard ship closing down net
X	1900	499	171856H	WH M- Night pos at 666996 will move at 0100
X	1949	500	171049H	WH 5- We are now departing causeway w/ re- maining troops

DECLASSIFIED

## DECLASSIFIED

UNIT: 3rd Battalion 3rd Marines  
 PLACE: Chu Lai, Viet Nam

CP D 180001 Aug65  
 CLOSED: 182400 Aug65

UNIT	TIME	SER NO	DTG	INCIDENTS, MESSAGES, ORDERS
X	0640	501	180640H	CP Group splashed in command tractor and headed for beach
X	0712	502	180712H	LCo receiving light fire from right flank
X	0725	503	180725H	LCo request for support from engineers to help with TNT
X	0740	504	180740H	ICo moving through village negative contact
X	0754	505	180754H	LCo collected a group of villagers bringing them back to CP
X	0808	506	180808H	ICo position report- we are at edge of village
X	0810	507	180810H	LCo sending villager back to beach
X	0817	508	180817H	WH 6 to WH P send all demolition kits ashore do you want all demo affirm send ammo truck ashore
X	0826	509	180826H	WH P requests to know door to where you want demo sent To right flank of the beach
X	0830	510	180830H	333A have thrown track and will head for beach in 15 min
X	0835	511	180835H	Kto 6 request to know if you are approaching our position WH 6 affirm
X	0839	512	180839H	WH 5 to WH 6 WH 16 lost contact with your group request you send someone back for him
X	0900	513	180900H	ICo lost contact with 333A they crossed river into SD territory
X	0905	514	180905H	ICo 333A crossed into SD territory. they were attacked by 15 VC we are firing rockets on them
X	0908	515	180908H	ICo rpt approx 20 VC at coord 700927
X	0930	516	180930H	MCo request helicopter to come to LSD 16 for resupply
X	1006	517	181006H	WH 2 am at coord 715925 have found 75 women and children in extensive tunnel system
X	1010	518	181010H	ICo 20 VC for which SD can not cover
X	1015	519	181015H	LCo on phase line bravo ICo located at coord 701926 have 5 or 6 WIA's ICo 6 evacuated as serious
X	1115	520	181115H	KCo at coord 714938 receiving small arms fire
X	1150	521	181150H	LCo and KCo on phase line Banana ICo on phase line apple receiving heavy small arms fire VC appear to be slipping to west
X	1200	522	181200H	ICo moving north no contact
X	1225	523	181225H	Slaveborn receiving small arms and mortars
X	1240	524	181240H	Slave born has 4 WIA's
X	1300	525	181300H	MCo providing security for Payable Whisky
X	1305	526	181305H	ICo departing to assist LVTs that are in trouble
X	1330	527	181330H	LVTs under heavy attack
X	1400	528	181400H	ICo receiving heavy fire
X	1405	529	181405H	WH 5 receiving mortar fire
X	1420	530	181420H	WH 5 calling fire missions (arty)
X	1430	531	181430H	WH 5 reports 5 KIAs and 22 wounded including attachments at coord 703925

DECLASSIFIED

## DECLASSIFIED

UNIT: 3rd Battalion 3rd Marines      OPENED: 180001 Aug65  
 PLACE: Chu Lai, Viet Nam      CLOSED: 182400 Aug65

UNIT	TIME	SLR NO	DTG	INCIDENTS, MESSAGES, ORDERS
X	1450	532	181450H	WH 6 departing for WH 5 position
X	1500	533	181500H	WH 6 to WH 3 keep starboard informed of what is happening
X	1501	534	181501H	WH 6 request recon helo to go to ICo flank
X	1515	535	181515H	ICo we see troops and tanks to right front
X	1519	536	181519H	WH 5 is moving out receiving heavy small ar fire
X	1520	537	181520H	MCo has made liaison with and tied in with SD G
X	1522	538	181522H	SLF is sending two companies
X	1525	539	181525H	KCo has 12 MIAs and 2 KIAs
X	1535	540	181535H	I 6 to WH 5 we have the ten men that were left to guard huey huey is gone LVTs turned north ten men slightly wounded LVT turning north follow route of India to phase line Banana
X	1540	541	181540H	I 2 is on the way to I 6
X	1550	542	181550H	WH 6 to WH 5 organize tanks, LVTs Ontos and people and proceed to my position
X	1552	543	181552H	WH 5 is sending out four casualties that were with tanks
X	1553	544	181553H	ICo does not think they can tow tank but will try
X	1555	545	181555H	WH 5 to ICo make sure you have all hands and gear before beginning departure
X	1600	546	181600H	WH 5 to ICo how many LVT are there
X	1601	547	181601H	WH 6 to WH 5 tanks LVTs Ontos are to remain together
X	1604	548	181604H	WH 5 to WH 6 trying to contact LVTs 25 and 41 have you seen them
X	1605	549	181605H	Troops in ICo position will assume ICo pos
X	1730	550	181730H	WH6 to WH3 am proceeding north have assume OPCOn SLF close with ICo
X	1857	551	181857H	WH 6 need mortar fire on 699929, want arty on 692934 if SD is not in area
X	1915	552	181915H	ICo have 2 KIA's sniper fire all around
X	1921	553	181921H	request helo e ac 705932 about 10 WIA
X	2000	554	182000H	ICo casualties being picked up by helo
X	2011	555	182011H	WH 6 request illum at last coord fired on
X	2015	556	182011H	WH 6 to 3 fire mission 81 illum 690720
X	2021	557	182021H	LCo is set in
X	2100	558	182100H	Sit Rep submitted to AG
X	2210	559	182210H	WH 6 has 3 KIA and 1 WIA at his pos request helo evac
X	2215	560	182215H	ICo made contact with VC
X	2235	561	182235H	ICo pinned down cancel illum
X	2345	562	182345H	WH 6 on move to CP

DECLASSIFIED

## DECLASSIFIED

UNIT: 3rd Battalion, 3rd Marines  
 PLACE: Chu Lai, Viet Nam

OPENED: 190001 Aug65  
 CLOSED: 192400 Aug65

I O	N U TIME	SER NO	DTG	INCIDENTS, MESSAGES, ORDERS
X	0120	532	190120H	WH 6 arrived at CP
X	0600	533	190600H	Request personnel losses all companies
X	0652	534	190652H	KCo has 12 WIA 2 KIA
X	0700	535	190700H	WH 6 to Stbd we have jumped off
X	0705	536	190705H	LCo on LOD witing for KCo to jump off
X	0725	537	190725H	LCo 10 KIA 44 WIA Unacct 7 Skeptic LCo 4 KIA 13 WIA 2 MIA
X	0807	538	190807H	WH 2 to Stbd enemy unit contacted was company or larger 57mm RR, 81mm mortar M79 Bar 40 V8 wounded plus 5 POW
X	0840	539	190840H	Gen WALT in area being escorted to WH 6 by S-2 scouts
X	0910	540	190910H	LCo on line with KCo negative contact
X	0951	541	190951H	KCo receiving small arms fire
X	1041	542	191041H	KCo is receiving fire from peninsula can not move
X	1143	543	191143H	WH 6 to Stbd VC inland from our position request two more aircraft
X	1305	544	191305H	NGF LnO can run mission from here if we have coord 726941
X	1325	545	191325H	NGF reports 6 VC launching Sampan at 6989
X	1340	546	191340H	DD will check Sampan
X	1515	547	191515H	WH 6 to Skeptic take all male adults with you we jump off at 1600
X	1600	548	191600H	WH to all wait 15 min before jumping off
X	1805	549	191805H	NGF requests to reg night def fires
X	1930	550	191930H	MCo neg report
X	1950	551	191950H	KCo 6 reports 4 WIA's
X	1955	552	191955H	MCo neg rpt
X	2140	553	192140H	MCo neg contact all quiet
X	2400	554	192400H	MCo neg sit rep

DECLASSIFIED

## DECLASSIFIED

UNIT: 3rd Battalion, 3rd Marines  
 PLACE: Chu Lai Viet Nam

OPENED: 200001 Aug65  
 CLOSED: 202400 Aug65

UNIT	TIME	SER NO	DTG	INCIDENTS, MESSAGES, ORDERS
X	0030	555	200030H	MCo neg sit rep
X	0100	556	200100H	MCo neg sit rep
X	0150	557	200150H	WH 6 to Stbd arty firing on left flank request to know if sudden death is in trouble neg
X	0200	558	200200H	MCo neg sit rep
X	0215	559	200215H	Stbd to WH retraction for morning has been cancelled add info after first light
X	0220	560	200220H	Wh to Stbd request to know if SSA3 is at your pos yes
X	0300	561	200300H	MCo Neg sit rep
X	0330	562	200330H	Stbd desires info and evidence of presence of crew served weapon evidence of CP activity and comm equip accurate estimate of kills and losses
X	0355	563	200355H	MCo neg sit rep
X	0420	564	200420H	Msg to Stbd re msg on verification of crew served
X	0500	565	200500H	MCo neg sit rep
X	0600	566	200600H	MCo neg sit rep
X	0810	567	200810H	ICo to WH 6 1st and 3rd maintaing regt security 3rd providing beach security
X	0830	568	200830H	LCo pstrol returned
X	0855	569	200855H	Stbd frag order 2065 received
X	0859	570	200859H	Do not execute 2055 UNHIL directed by this Hq
X	0930	571	200930H	Wh 6 en route to Stbd Cp
X	0945	572	200945H	From S5C5 refer your 200807 A. 1 B. 7 C. 0 Remaining vehicles have full crews
X	1000	573	201000H	WH 6 to WH 5 change to 2065 L&K proceed to green beach Skeptic L and CP move to tight perimeter
X	1050	574	201050H	KCo, LCo, and WH CP Bravo commenced movement to beach
X	1240	575	201240H	1st wave of Whisky btry has been retracted
X	1241	576	201241H	KCo and LCo on the beach
X	1310	577	201310H	WH 5 leaving Stbd CP for beach
X	1325	578	201325H	WH 5 joining KCo and LCo on the beach
X	1328	579	201328H	VC climbing ridge at 710978 approx 20
X	1330	580	201330H	1/7 CP group has arrived at this position
X	1400	581	201400H	1/7 troops are starting to come in 1/7 request permission to go to beach WH M is is still in position
X	1412	582	201412H	Skeptic L is to stay in place
X	1441	583	201441H	WH is departing for beach
X	1550	584	201550H	Departed for LST
X	1610	585	201610H	Aboard LST
X	1940	586	201940H	Arrived at causeway and begin disembarking
X	2230	587	202230H	WH L followed by SD H and rest of WH element FM 3 Am in position on MLR everyone accounted for OP's manned

DECLASSIFIED



DECLASSIFIED

UNIT: 3rd Battalion, 3rd Marines  
 PLACE: Chu Lai, Viet Nam

OPENED: 210001H Aug65  
 Closed: 212400H Aug65

I O	N U T I M E	SER NO	DTG	INCIDENTS, MESSAGES, ORDERS
X	0005	588	210005H	SW M neg sit rep
X	0015	589	210015H	SW I, L, M neg sit rep
X	0017	590	210017H	SW M patrol departed CP 202400H
X	0047	591	210047H	Shove 6 Tomorrow morning MAOV is sending H H HOLMBURY to Chu Lai for Star lite information for military report to JCS He will bring 1-2 ARVN officers with him they depart Saigon 0800 in army U-8 This unit to talk to informed people who took part in Star Lite operation
X	0055	592	210055H	LCo received M-1 Carbine fire coord 605015
X	0130	593	210130H	MCo patrol returned neg contact
	0400	594	210400H	I, L, MCo neg sit rep
X	0405	595	210405H	Last MCo patrol returned
X	0759	596	210759H	LCo neg sit rep
X	1515	597	211515H	Gen WESTMORELAND in CP area
X	1525	598	211525H	Gen WESTMORELAND departed area for 2/4
X	1605	599	211605H	I, L, MCo neg sit rep
X	1810	600	211810H	MCo patrol out to tie in with 155's by OP
X	2005	601	212005H	LCo ROADBLOCK rpt
X	2006	602	212006H	SW I, L, MCo neg sit rep
X	2045	603	212045H	MCo patrol departing
X	2100	604	212100H	FM AG 3 Reports indicate that VC Bn's may probe MLR tonight All MLR companies alerted SW LCo has alert squad standing by for reaction
X	2215	605	212215H	MCo observed a vehicle moving north and stopped about 900 meters from OP #1
	2300	606	212300H	One LVT dispatched to ICo to deliver two PRC 10's
X	2350	607	212300H	SW LCo neg sit rep
X	2352	608	212352H	3 rds 81 illum fired for MCo coord 579032

DECLASSIFIED

## DECLASSIFIED

UNIT: 3rd Battalion, 3rd Marines  
 PLACE: Chu Lai, Viet Nam

OPENED: 220001H Aug65  
 CLOSED: 222400H Aug65

UNIT	TIME	SER NO	DTG	INCIDENTS, MESSAGES, ORDERS
X	0005	609	220005H	L, M, ICo neg sit rep
X	0115	610	220115H	OP #1 believes to see movement to front & rear. Will observe
X	0220	611	220220H	OP #1 reports fire fight in Binh Son (2)
X	0400	612	220400H	I, L, MCo neg sit rep
X	1020	613	221020H	SW MCo patrol has departed
X	1040	614	221040H	SW LCo 3rd plt patrol now departing
X	1050	615	221050H	FR TS 3 as of 220900H KCo is designated as regt reserve vice GCo
X	1220	616	221220H	I, L, MCo neg sit rep
X	1245	617	221245H	SW LCo 3rd plt patrol now at CP #3
X	1305	618	221305H	LCo 3rd platoon has returned from patrol
X	1455	619	221455H	MCo patrol returned negative contact
X	1600	620	221600H	I, L, MCo neg sit rep
X	2000	621	222000H	Roadblock report
X	2005	622	222005H	I, L, MCo neg sit rep
X	2030	623	222030H	MCo 1st platoon patrol departed
X	2105	624	222105H	LCo patrol 2 alpha departed lines
X	2130	625	222130H	ICo trip fl re set off and a patrol dispatched neg results
X	2145	626	222145H	LCo patrol 2 alpha now in position
X	2245	627	222245H	MCo heard one round at 576021
X	2300	628	222300H	ICo spotted movement to front fired 10 rds. arty illum with neg results
X	2315	629	222315H	MCo patrol departing
X	2315	630	222315H	LCo has one (1) WIA by incoming 60mm mortar
X	2350	631	222350H	MCo patrol #3 departing Co CP
X	2400	632	222400H	ICo threw 1 frag grenade neg results

DECLASSIFIED

## DECLASSIFIED

UNIT: 3rd Battalion, 3rd Marines  
 PLACE: Chu Lai, Viet Nam

OPENED: 230001H Aug65  
 CLOSED: 232400H Aug65

UNIT	TIME	SER NO	DTG	INCIDENTS, MESSAGES, ORDERS
X	0010	632	230010H	ICo reported hearing small arms fire to the front of 3rd platoon
X	0032	634	230032H	ICo reports all quiet illum stopped
X	0105	635	230105H	LCo patrol charlie departed
X	0205	636	230205H	LCo layout patrol charlie now in position
X	0215	637	230215H	MCo patrol # 2 returned no contact
X	0330	638	230330H	MCo patrol # 3 returned no contact
X	0345	639	230345H	ICo neg sit rep fired 11 M-79 rds
X	0358	640	230358H	MCo neg sit rep LCo neg sit rep
X	0430	641	230430H	LCo patrol charlie returned
X	0445	642	230445H	MCo patrol # 1 returned
X	0730	643	230730H	I, L, MCo neg sit rep
X	0805	644	230805H	AO sweep reports large gathering of men at 653977 Women leaving carrying items
X	0850	645	230850H	MCo patrol alpha has departed
X	1115	646	231115H	LCo patrol 2 alpha departed
X	1200	647	231200H	LCo patrol 2 alpha at CP # 1 I, L, MCO neg sitrep
X	1440	648	231440H	MCo patrol returned
X	1620	649	231620H	K, L, MCo neg sit rep
X	1645	650	231645H	LCo 2 alpha returned Fired at PF's 595975
X	1710	651	231710H	MCo has completed test firing
X	2000	652	232000H	L, MCo neg sit rep
X	2030	653	232030H	LCo patrol 3 alpha departing
X	2200	654	232200H	MCo patrol # 1 out
X	2259	655	232259H	LCo (FT) layout departed
X	2330	656	232330H	Neg sit rep to Regt A-3
X	2345	657	232345H	LCo patrol bravo returned
X	2350	658	232350H	LCo lost contact with 2nd platoon patrol, 3rd platoon patrol returned
X	2352	659	232352H	Bendix will fire illum 81's at 0100 around their position
X	2400	660	232400H	I, L, K, MCo neg sit rep

DECLASSIFIED

## DECLASSIFIED

UNIT: 3rd Battalion, 3rd Marines  
 PLACE: Chu Lai, Viet Nam

OPENED: 240001H Aug65  
 CLOSED: 242400H Aug65

UNIT	TIME	SER NO	DTG	INCIDENTS, MESSAGES, ORDERS
X	0052	661	240052H	LCo bravo patrol returned
X	0400	662	240400H	K, L, MCo neg sit rep
X	0405	663	240405H	MCo patrols 1 and 3 have returned neg contact
X	0415	664	240415H	LCo 1 alpha has departed
X	0500	665	240500H	MCo patrol departed 2330 and returned at 0448 neg contact
X	0540	666	240540H	LCo radio check with patrol 1 alpha neg sit rep
X	0610	667	240610H	LCo patrol has returned
X	0622	668	240622H	H&SCo patrol departed
X	0805	669	240805H	H&S (Y) at CP #1 have three VN apprehended
X	0820	670	240820H	H&S (Y) at CP #2
X	0830	671	240830H	K, L, MCo neg sit rep
X	1005	672	241005H	H&S (Y) at CP #3 apprehended 20POW's
X	1210	673	241210H	LCo patrol departed
X	1305	674	241305H	K, L, MCo neg sit rep
X	1310	675	241310H	LCo patrols at MI Way
X	1315	676	241315H	MCo patrol 2 alpha departed
X	1425	677	241425H	WH 6 departing area for WH position with G-3 representative
X	1455	678	241455H	WH 6 and G-3 representative is at WH LCo
X	1550	679	241550H	KCo 3rd platoon has returned
X	1605	680	241605H	WH 6 and G-3 representative on way to WH I request guide to be sent to road
X	1615	681	241615H	WH 6 in CP area
X	1630	682	241630H	K, L, MCo neg sit rep
X	1715	683	241715H	AmTrucks have arrived across river
X	1830	684	241830H	MCo patrol returned
X	1940	685	241940H	LCo patrol have returned to area
X	1945	686	241945H	Swain check point to report to After glow
X	2025	687	242025H	K, L, MCo neg sit rep
X	2055	688	242055H	LCo bravo patrol departed
X	2105	689	242105H	KCo alpha patrol departed
X	2110	690	242110H	Booth relieve Swain on OP order 327-65
X	2112	691	242112H	KCo 1st platoon patrol departed
X	2150	692	242150H	MCo #3 patrol departed
X	2250	693	242250H	Afterglow 3 called stated Bendix will fire illum at 2400H
X	2345	694	242345H	81's firing illum over MCo by pond by request
X	2400	695	242400H	SW K, L, MCo neg sit rep

DECLASSIFIED

## DECLASSIFIED

UNIT: 3rd Battalion, 3rd Marines  
 PLACE: Chu Lai, Viet Nam

OPENED: 250001H Aug65  
 CLOSED: 252400H Aug65

UNIT	TIME	SER NO	DTG	INCIDENTS, MESSAGES, ORDERS
X	0015	696	250015H	MCo 3rd platoon patrol returned Two illum fired
X	0050	697	250050H	LCo patrol has returned negative contact
X	0100	698	250100H	MCo patrol has departed
X	0115	699	250115H	KCo patrol has returned
X	0410	700	250410H	K, L, MCo negative sit rep
X	0420	701	250420H	LCo 2nd platoon patrol has departed
X	0550	702	250550H	MCo scout ambush returned negative contact
X	0620	703	250620H	H&SCo tango patrol departed
X	0640	704	250640H	KCo patrol returned negative contact
X	0750	705	250750H	LCo patrol 2 alpha at CP #3
X	0755	706	250755H	MCo patrol 1 alpha departed L, MCo negative sit rep
X	0810	707	250810H	LCo patrol 2 alpha in
X	0825	708	250825H	ICo at CP #3
X	0830	709	250830H	Yankee has picked up 1 VN
X	0840	710	250840H	LCo left flank received one round sniper fire at 0830
X	0940	711	250940H	HH 6 to OP #1 via 7th Marines
X	1200	712	251200H	K, L, MCo negative sit rep
X	1355	713	251355H	MCo patrol 1 alpha returned
X	1635	714	251635H	K, L, MCo negative sit rep
X	1945	715	251945H	KCo patrol bravo departed
X	1955	716	251955H	LCo patrol bravo departed
X	2026	717	252026H	SW K, L, MCo negative sit rep
X	2046	718	252046H	KCo roadblock report
X	2126	719	252126H	SW W fired 3 illum over OP #1 for S KCo
X	2135	720	252135H	SW M patrol 3 departed
X	2140	721	252140H	SW K received one round called in arty illum
X	2150	722	252150H	SW K (A) patrol departed
X	2305	723	252305H	SW L (B) patrol returned negative contact SW L reports auto weapon fire and flares to their front
X	2310	724	252310H	SW M (2) patrol departed
X	2400	725	252400H	SW I, L, M negative sit rep
X	2400	726	252400H	Sit rep to AG 3

DECLASSIFIED

## DECLASSIFIED

UNIT: 3rd Battalion, 3rd Marines  
 PLACE: Chu Lai, Viet Nam

OPENED: 260001H Aug65  
 CLOSED: 262400H Aug65

UNIT	TIME	SER NO	DTG	INCIDENTS, MESSAGES, ORDERS
X	0100	727	260100H	FM AG 3 sudden death msg VC have withdrawn from area Arty unnecessary at this time
X	0230	728	260230H	MCo reports three unidentified persons set off trip flares in front of first platoon then disappeared Believed heading toward LC
X	0300	729	260300H	LCo reports one man running under illum to left flank of first platoon 1 round fired at him
X	0325	730	260325H	SW M reports one bunker has caved in 2 Marin were in it one appears to have a broken thigh or pelvic bone 16 notified
X	0330	731	260330H	SW M patrol returned
X	0355	732	260355H	SW K, L, M negative sit rep
X	0030	733late	260030H	SW M patrol 3 reported receiving 3 rds small arms fire and possibly one grenade coord BT 602014
X	0445	734	260445H	SW L patrol lpha departed
X	0520	735	260520H	SW L 1st platoon patrol entering lines
X	0620	736	260620H	SW M patrol has returned
X	0625	737	260625H	SW K 1st platoon layout returned to lines
X	0800	738	260800H	SW L departed from the Trung Phan peninsula by LVT
X	0800	739	260800H	SW K, M negative sit rep
X	0855	740	260855H	SW L on the beach 632022
X	1220	741	261220H	MCo 2 alpha at CP #3
X	1320	742	261320H	MCo 2 alpha at CP #3
X	1343	743	261343H	MCo 2 alpha at CP #3
X	1410	744	261410H	LCo on the beach LVT's on station
X	1430	745	261430H	LCo on the way to Company area
X	1445	746	261445H	MCo 2 alpha returned negative contact
X	1500	747	261500H	LCo back in position Destroy cave at 655006
X	1550	748	261550H	KCo negative sit rep
X	1620	749	261620H	MCo negative sit rep
X	1855	750	261855H	WH I has 3 VCS taken to AG Collection Point
X	1950	751	261950H	SW K roadblock report
X	2020	752	262020H	SW K, L, M negative sit rep
X	2035	753	262035H	SWK reports suspected movement at BT 549012 Requested Arty illum
X	2040	754	262040H	First Arty illum fired for SW K
X	2115	755	262115H	AG 3 delay change of lines for 24 hours due to weather Co notified
X	2124	756	262124H	WH 24 VC blew bridge BS 577964 Can still take light traffic
X	2200	757	262200H	SW 6 request permission to change lines as scheduled, but delay 3/3 move Permission granted by AG 5 - Co notified
X	2330	758	262330H	AG 3 reports Bendix just received 16 incoming rounds
X	2400	759	262400H	SW K, L, M negative sit rep

DECLASSIFIED

## DECLASSIFIED

UNIT: 3rd Battalion, 3rd Marines  
 PLACE: Chu Lai, Viet Nam

OPENED: 270001H Aug65  
 CLOSED: 272400H Aug65

I O N U T	TIME	SER NO	DTG	INCIDENTS, MESSAGES, ORDERS
X	0030	760	270030H	SW M requests 81 illum on OP #3
X	0035	761	270035H	AG 2 primary password compromised, directed to switch to alternate
X	0130	762	270130H	SW M 3rd platoon ambush departed at 2330 returned at 0120
X	0400	763	270400H	K, L, MCo negative sit rep
X	0401	764	270401H	MCo platoon patrol returned
X	0820	765	270820H	K, L, MCo negative sit rep
X	1447	766	271447H	KCo CP 553021
X	1530	767	271530H	1/7 on MLR
X	2010	768	272010H	WHM 3 has met WH Yankee and returning to WH CP
X	2015	769	272015H	K, L, MCo negative sit rep

DECLASSIFIED

## DECLASSIFIED

UNIT: 3rd Battalion, 3rd Marines  
 PLACE: Chu Lai, Viet Nam

OPENED: 290001H Aug 65  
 CLOSED: 292400H Aug 65

UNIT	TIME	SER NO	DTG	INCIDENTS, MESSAGES, ORDERS
X	0400	782	290400H	K, L, MCo negative sit rep
X	0800	783	290800H	K, L, MCo negative sit rep
X	1200	784	291200H	K, L, MCo negative sit rep
X	1600	785	291600H	K, L, MCo negative sit rep
X	2000	786	292000H	K, L, MCo negative sit rep
X	2400	787	292400H	K, L, MCo negative sit rep

DECLASSIFIED



DECLASSIFIED

UNIT: 3rd Battalion, 3rd Marines  
 PLACE: Chu Lai, Viet Nam

OPENED: 300001H Aug65  
 CLOSED: 302400H Aug65

IO N U T T	TIME	SER NO	DTG	INCIDENTS, MESSAGES, ORDERS
X	0240	788	300240H	SW 34 reported that Ontos had suspected movement vic (BT 535023) fired illum saw one man drop to ground fired 5 to 8 rounds patrol dispatched to check area neg results
X	0404	789	300404H	K, L, MCo negative sit rep
X	0800	790	300800H	K, L, MCo negative sit rep
X	1200	791	301200H	K, L, MCo negative sit rep
X	1600	792	301600H	K, L, MCo negative sit rep
X	1622	793	301622H	Detatch one platoon LCo to 1/4
X	2000	794	302000H	K, L, MCo negative sit rep
X	2400	795	302400H	K, L, MCo negative sit rep

DECLASSIFIED

UNIT: 3rd Battalion, 3rd Marines  
 PLACE: Chu Lai, Viet Nam

OPENED: 010001H Aug65  
 CLOSED: 312400H Aug65

I O	N U TIME	SER NO	DTG	INCIDENTS, MESSAGES, ORDERS
X	0400	796	310400H	K, L, MCo negative sit rep
X	0800	797	310800H	K, LCo negative sit rep
X	1200	798	311200H	K, L, MCo negative sit rep
X	1520	799	311520H	Requested and received permission from 2/4 (Bendix) to maintain CP area on a non-blackout basis
X	1600	800	311600H	Pass word has been compromised for today use new code #52
X	1601	801	311601H	K, L, MCo negative sit rep
X	1700	802	311700H	2/4 patrol plan and frag order received
X	1700	803	311700H	1/4 frag order #83 and OpPlan MARQUIS received
X	2020	804	312020H	Bendix will be illuminating throughout their TAOR at 2300 0200, 0400
X	2025	805	312025H	K, MCo negative sit rep
X	2026	806	312026H	FR Pied Piper location of ambushes

## HEADQUARTERS

3rd Battalion, 3rd Marines, Marine #23  
 3rd Marine Division (Rein), FMF  
 c/o Fleet Post Office  
 San Francisco, California, 96601

16 August 1965

From: S-2 Officer  
 To: Distribution List

Ref: (a) RegtO 3800.1E

Subj: Standing Operating Procedure for Intelligence

## MEASURES FOR HANDLING CAPTURED PERSONNEL, DOCUMENTS AND MATERIAL

1. General. Prisoners are one of the most valuable sources of information of the enemy. Officers and men will be instructed to capture prisoners whenever practicable. Humane treatment as prescribed by FM 27-10 (The Law of Land Warfare) will be the rule at all times. Indoctrination to this end will be conducted at all levels of this command.
2. Handling of Prisoners Upon Capture. Immediately after capturing prisoners, units will disarm, search, segregate and tag them.
3. Tagging. Tagging will consist of completing the standard POW/Equipment tag and affixing it to the prisoner. For the place of capture, give the locale and grid coordinates (e.g., In S edge of vds at AT837862). On the "Circumstances" line describe what the prisoner was doing when he was captured such as Member of MG Crew. Gun ran out of ammo. 3 other men in crew KIA". The "Capturing unit" sqd, 2d plt, A Co, 3d Mar.). When possible include the name of the individual making the capture. Including this data insures your unit of getting credit for capturing the prisoner. If the prisoner has any documents, mark X in the "Yes" section of the PW tag and fill in the DOCUMENT portion of the tag. Serial numbers will be printed in the upper right hand corner of the PW and DOCUMENT portions of the tag prior to issue for an operation. The numbers on the two portions will be identical, so the prisoner and his documents can be matched later.
4. Prisoner Guards. Troops detailed to evacuate and guard prisoners will be thoroughly schooled in the instructions contained in paragraphs 10 and 11.
5. Wounded Prisoners. Wounded prisoners requiring hospitalization shall be evacuated through medical channels with a report made to the this battalion S-2, who will remove any documents and tag them. If the prisoner's condition permits, a tactical interrogation may be conducted.

Encl #17

6. Tagging of Documents. Tagging will consist of attaching and completing the DOCUMENT portion of the combination PW/DOCUMENT tag. When documents are found which cannot be identified with a PW or when it can be established that the owner/carrier was killed, the DOCUMENT portion of the tag only should be used, and the PW portion of the tag should be destroyed or crossed through. The CIRCUMSTANCES line should contain an explanation as to why only the DOCUMENT part of the tag is being forwarded in the intelligence channels.

7. Marking. In order to avoid defacement and possibility of misleading the analyst, documents will not be marked under any circumstances by subordinate echelons.

8. Guarding and Reporting. All items of equipment of an unusual nature will be guarded by the capturing unit and safeguarded in place with a report to this Headquarters (S-2). Where danger of recapture exists, every effort will be made to evacuate the equipment. If the equipment is too large to evacuate, all name plates and documents will be removed and forwarded with details of capture. Photos will be taken if possible and the equipment will be destroyed.

9. Souvenirs. Individuals desiring to retain documents as souvenirs will insure that they have their name on the CAPTURING UNIT line of the DOCUMENT tag and have checked the YES square. If documents are declared of no further intelligence value by Division Headquarters every effort will be made to return the document to the capturing individual. Enemy material will not be returned as souvenirs by individuals unless a release slip is obtained from Division Headquarters. This slip must be fastened to the souvenir at all times. The purchase, sale or exchange of captured material which has not been designated as a souvenir is prohibited.

10. INSTRUCTIONS TO TROOPS GUARDING PRISONERS OF WAR

- a. Maintain segregation of prisoners at all times.
- b. Prevent prisoners from discarding or destroying any insignia or document overlooked or not taken by the capturing unit. Guards bringing up the rear will be instructed to collect any documents dropped by the prisoners.
- c. Prevent anyone other than authorized interrogators from speaking to the prisoners.
- d. Prevent anyone from giving prisoners food, drink, or tobacco prior to interrogation. Prevent the PW from going to the head.
- e. Enforce silence among the prisoners at all times.
- f. Deliver the prisoners to the collecting point of this headquarters as soon as possible.

11. BE PREPARED TO ANSWER THE FOLLOWING QUESTIONS FOR THE INTERROGATOR-  
TRANSLATOR

- a. Has the prisoner been searched? If so, what was found?
- b. What condition is the prisoner's uniform in? What unit insignia and insignia of rank are on his uniform? Is there anything unusual about his uniform?
- c. Has the prisoner been fed, given water, tobacco, or allowed to go to the head?
- d. How has the prisoner acted during the time you were with him?
- e. What was the result of previous interrogation?

In the event that you turn a prisoner over to guard personnel at a collecting point or stockade tell these personnel all you know or have observed about the PW and tell them to pass this information on to the interrogator or Intelligence Officer.

*D. W. Stump*  
D. W. STUMP

HEADQUARTERS  
 3rd Battalion, 3rd Marines, Marine #23  
 3rd Marine Division (Rein), FMP  
 c/o Fleet Post Office  
 San Francisco, California, 96601

21 August 1965

From: S-2  
 To: Distribution List  
 Subj: Equipment, Weapons, and POW's captured by 3/3 on Operation  
 from 18-20 August

1. TURNED OVER TO 7TH MARINES FORWARD (INDIA)

- a. One Russian Rifle
- b. 2 - BARs
- c. 8 - M-1's
- d. 1 - M-1 Carbine
- e. 1 - M-79
- f. 3 M-14's
- g. 1 - Cal..45 Pistol
- h. 1 - STEN GUN (British)
- i. ChiCom 7.62MM Modified Submachine Gun
- j. 16 - POW's

2. DELIVERED TO 4TH MARINES COLLECTION POINT BY S-2

- a. 18 August - 7 POW's (KILO)
- b. 19 August - 10 POW's (LIMA)
- c. 20 August - 3 POW's (KILO)
- d. 20 August - 8 Packs containing TNT, 10 Frag grenades (Mostly Chinese), and 12 M-79 Rounds (LIMA)

3. PLACED ON HELICOPTERS WITH INSTRUCTIONS TO DELIVER TO 4TH MARINES  
 REGIMENTAL COLLECTION POINT.

- a. 20 August - 20 Packs containing documents, clothing, explosives, personal gear, time fuze, and detonating cord (LIMA)

- b. 12 Grenades (Potato masher, old style American frag, Chinese frag) (LIMA)
- 4. DESTROYED
  - a. Several pounds of TNT and other explosives (LIMA)
  - b. 10 Blasting caps (LIMA)
- 5. TURNED OVER TO 4TH MARINES S-2
  - a. 2 M-1's (INDIA)
  - b. 1 Russian Rifle (INDIA)
  - c. Two packs with clothing and documents (LIMA)
- 6. TURNED OVER TO EOD (LIMA)
  - a. One satchel charge
  - b. 3 Blasting caps and electric cord
  - c. One Chinese mine
- 7. CAPTURED BY PF WITH INDIA
  - a. 1 - M-1
- 8. HELD
  - a. 2 - M-14
  - b. 3 - M-1 Carbines
- 9. VC CASUALTIES
  - a. 200 Confirmed dead
  - b. Undetermined number of VC casualties inflicted by supporting weapons

*D. W. Stump*  
D. W. STUMP

DECLASSIFIED

PATROL REPORT  
(#6 OF 31 JULY 1965)

LIMA  
CHU LAI  
021800H AUG 1965

LAYOUT/AMBUSH PATROL

SERIES L701, SHEET 6757 III

1. 1ST FT, 3RD SQUAD, 1ST PLATOON, COMPANY "L", 3/3
2. LAYOUT/AMBUSH PATROL ON OVERLAY ROUTE.
3. 312045H
4. 010200H
5. SEE OVERLAY
6. AT 2335H, HEARD NOISE AND MOVEMENT IN VILLAGE WHILE IN LAYOUT POSITION. MEN AND WOMEN WERE TALKING, SEEMED TO START IN CENTER OF VILLAGE.
7. NONE
8. NONE
9. GOOD
10. NONE

/s/H. E. Thomas  
H. E. THOMAS  
LCpl USMC

Encl #19

DECLASSIFIED



DECLASSIFIED

LIMA  
CHU LAI  
021800H AUG 65  
TOD: 312045H  
TOR: 010200H

*K*  
0-33

02  
58

00  
56

DECLASSIFIED

DECLASSIFIED

PATROL REPORT  
(#1 OF 1 AUGUST 65)

INDIA  
CMC LAI  
021800H AUG 65

RECON/COMBAT PATROL

SERIES 1701, SHEET 6757 III

1. 3RD PLATOON, COMPANY "I", 3/3
2. GAIN ANY TYPE OF INFORMATION OR CONTACT WITH THE ENEMY
3. 010630H
4. 011130H
5. SEE OVERLAY SHEET
6. NONE
7. NONE
8. NONE
9. GOOD
10. NONE

/s/J. P. Elgas  
J. P. ELGAS  
1/Lt USMC

DECLASSIFIED

End 20

DECLASSIFIED

PATROL REPORT  
(#2 OF 1 AUGUST 65)

LIMA  
CHU LAI  
011800H AUG 65

RECON/COMBAT PATROL

SERIES L701, SHEET 6757 III

1. 1ST PLATOON, COMPANY "L", 3/3
2. TO OBTAIN INFORMATION ON OR CONTACT THE ENEMY
3. 011000H
4. 011200H
5. SEE OVERLAY SHEET
6. NONE
7. ATTITUDE OF VILLAGERS IN DONG BINH (2) WAS INDIFFERENT; NOTHING UNUSUAL TO REPORT.

AT 1045H, RAN INTO SWAIN "I" PATROL AT COORD BT 563000.

VILLAGERS IN OUTSKIRTS OF TRUNG AN (2) VIC COORD BT 571004 SEEMED INDIFFERENT.

VILLAGERS IN HOA VAN (2) WERE VERY FRIENDLY; NOTHING UNUSUAL TO REPORT

8. NONE
9. GOOD
10. RECOMMEND THAT THESE PATROLS BE PROVIDED WITH A MEDICAL KIT FOR PEOPLE TO PEOPLE PURPOSES.

/s/G. R. Langford  
G. R. LANGFORD  
1/Lt USMC

*Encl #21*

DECLASSIFIED

01  
56

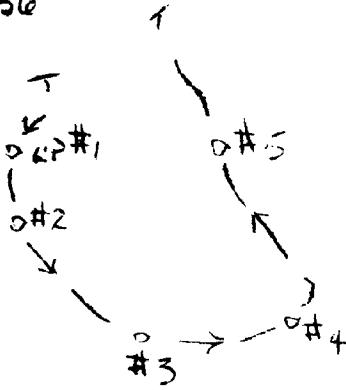

LIMA  
 CHU LAI  
 021800H AUG 65  
 TOD: 011000H  
 TOR: 011200H

05  
60

INDIA  
 CHU LAI  
 021800H AUG 65  
 TOD: 010630H  
 TOR: 011300H

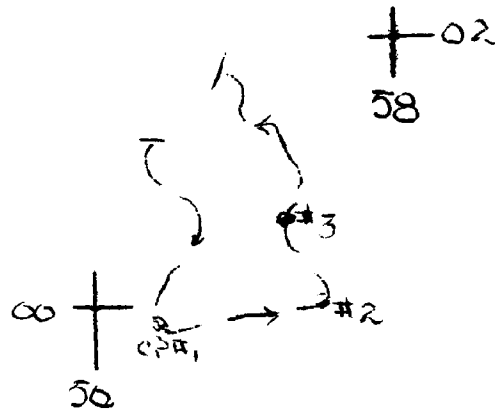

DECLASSIFIED

PATROL REPORT  
(#1 OF 2 AUG 1965)

MIKE  
CHU LAI  
031800H AUG 1965

AMBUSH PATROL

SERIES L701, SHEET 6757 III

1. 3RD SQUAD, COMPANY "M", 3/3
2. SET UP AMBUSH IN FRONT OF FRIENDLY LINES
3. 021945H
4. 022400H
5. VIC COORD BT 599019
6. NONE
7. NONE
8. NONE
9. GOOD
10. NONE

/s/T. Holland  
T. HOLLAND  
Cpl USMC

DECLASSIFIED

encl #22

DECLASSIFIED

PATROL REPORT  
(#2 OF 2 AUG 1965)

LIMA  
CHU LAI  
031800H AUG 1965

LAYOUT PATROL

SERIES L701, SHEET 6757 III

1. 1ST FT, 1ST SQUAD, 1ST PLATOON, COMPANY "L", 3/3
2. LAYOUT PATROL
3. 022042H
4. 030300H
5. SEE OVERLAY
6. NONE
7. NONE
8. NONE
9. GOOD
10. NONE

/s/J. E. McOellin  
J. E. MCOELLIN  
Cpl USMC

DECLASSIFIED

Serial #23

DECLASSIFIED

04  
53

LIMA  
CHU LAI  
031800H AUG 1965  
TOD: 022042H  
TOR: 030300H

04  
53

95  
60

DECLASSIFIED

DECLASSIFIED

PATROL REPORT  
(#3 OF 2 AUG 1965)

MIKE  
CHU LAI  
031800H AUG 1965

LAYOUT PATROL

SERIES L701, SHEET 6757 III

1. 1ST FT, 2ND SQUAD, 1ST PLATOON
2. LAYOUT IN POSITION ON OVERLAY ROUTE
3. 022100H
4. 022400H
5. SEE OVERLAY
6. NONE
7. NONE
8. NONE
9. GOOD
10. NONE

/s/W. E. Boles  
W. E. BOLES  
Cpl USMC

DECLASSIFIED

Encl #24



DECLASSIFIED

MIKE  
CHU LAI  
031800H AUG 1965  
TOD: 022100H  
TOR: 022400H

+ 04  
57 

+ 01  
60

DECLASSIFIED

DECLASSIFIED

PATROL REPORT  
(#1 OF 3 AUG 1965)

INDIA  
CHU LAI  
041800H AUG 1965

COMBAT/RECON PATROL

SERIES L701, SHEET 6757III

1. 3RD SQUAD, 2ND PLATOON, COMPANY "I", 3/3
2. TO SEEK OUT AND CAPTURE OR DESTROY ANY ENEMY
3. 030100H
4. 030500H
5. SEE OVERLAY
6. NONE
7. NONE
8. NONE
9. GOOD
10. NONE

/s/C. Enos  
C. ENOS  
Cpl USMC

DECLASSIFIED

Final #25

DECLASSIFIED

INDIA  
CHU LAI  
041800H AUG 1965  
TOD: 030100H  
TOR: 030500H

+ 04  
53



+ 99  
56

DECLASSIFIED

DECLASSIFIED

PATROL REPORT  
(#2 OF 3 AUG 1965)

MIKE  
CHU LAI  
041800H AUG 1965

RECON/COMBAT PATROL

SERIES L701, SHEET 6757 III

1. 1ST SQUAD, 1ST PLATOON, COMPANY "M", 3/3
2. RECON OF AREA IN FRONT OF PLATOON POSITIONS ON MLE
3. 030200H
4. 030330H
5. SEE OVERLAY
6. NONE
7. NONE
8. NONE
9. GOOD
10. NONE

/s/C. Lynn  
C. LYNN  
Sgt USMC

DECLASSIFIED

Encl 26

DECLASSIFIED

MIKE  
CHU LAI  
041800H AUG 1965  
TOD: 030200H  
TOR: 030330H

+ 04  
57

9A2  
CP#1

+ 01  
60

DECLASSIFIED

DECLASSIFIED

PATROL REPORT  
(#3 OF 3 AUG 1965)

INDIA  
CHU LAI  
041800H AUG 1965

RECON/COMBAT PATROL

SERIES L701, SHEET 6757 III

1. 3RD PLATOON, COMPANY "I", 3/3
2. GAIN ANY TYPE INFORMATION OR CONTACT WITH VC.
3. 030545H
4. 030845H
5. SEE OVERLAY
6. NONE
7. NONE
8. NONE
9. GOOD
10. NONE

/s/J. P. Elgas  
J. P. ELGAS  
1/Lt USMC

DECLASSIFIED

Encl #27

ENDIA  
CHU LAI  
041800H AUG 1965  
TOD: 030545H  
TOR: 030845H

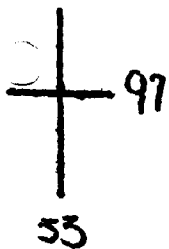
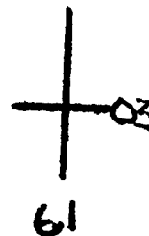
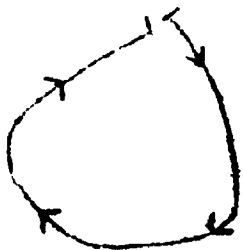

DECLASSIFIED

PATROL REPORT  
(#4 OF 3 AUG 1965)

MIKE  
CHU LAI  
041800H AUG 1965

RECON/COMBAT PATROL

SERIES L701, SHEETS 6757 II, III

1. 1ST AND 3RD SQUADS 2ND PLATOON, COMPANY "M", 3/3
2. MOVE ALONG ROUTE DEPICTED ON OVERLAY SEARCHING FOR EVIDENCE OF VC ACTIVITY.
3. 030815H
4. 031120H
5. SEE OVERLAY
6. AT 0845H, VIC COORD BT 581029, FOUND 55 GALLON DRUM W/APPROXIMATELY 25% GASOLINE.

AT 0930H, VIC COORD BT 600021, CHECKED YOUNG MEN ALONG BEACH FOR IDENTIFICATION. THOUGH ALL HAD IDENTIFICATION PAPERS THEY ASSUMED AN ARROGANT YET NOT A BELLIGERENT ATTITUDE.

AT 1025H, VIC COORD BT 581019, PICKED UP MAN WITH NO I.D. CARD WEARING UTILITY SHIRT. HE WAS RETURNED TO BN AREA.

7. MANY INDIGENOUS PERSONNEL WERE SEEN ALONG THE PATROL ROUTE. ALL WERE CHECKED FOR IDENTIFICATION.

MAP CORRECTION: VILLAGES AT COORDS BT 586026 AND BT 604019 DO NOT EXIST.

8. NONE
9. EXCELLENT
10. I RECOMMEND THAT WE HAVE A LOT OF I.D. CHECKS. I FEEL THAT THE MORE CONTACT WE HAVE WITH THE PEOPLE THE GREATER CHANCE OF WINNING SOME TO OUR SIDE.

/s/F. C. Moring  
F. C. MORING  
1/Lt USMC



MIKE  
CHU LAI  
041800H AUG 1965  
TOD: 030815H  
TCR: 031120H

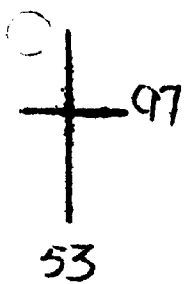
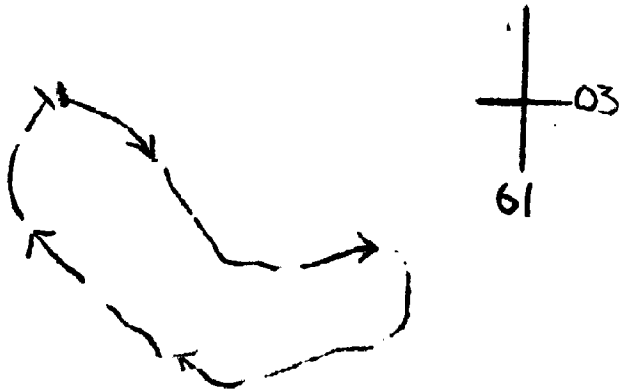

DECLASSIFIED

PATROL REPORT  
(#5 OF 3 AUG 1965)

LIMA  
CHU LAI  
041800H AUG 1965

RECON/COMBAT PATROL

SERIES L701, SHEET 6757 III

1. 1ST AND 2ND SQUADS, 1ST PLATOON, COMPANY "L", 3/3
2. RECON/COMBAT PATROL OF ASSIGNED ROUTE
3. 031300H
4. 031605H
5. SEE OVERLAY
6. VIC COORD BS 571995, TWO MALES, MIDDLE AGED, APPROACHED POINT AROUND CURVE OF PATH. IMMEDIATELY TURNED AND RAN OUT OF SIGHT. WE COULD NOT FIND THEM AS WE DID NOT SEE THEIR FACES.

VIC COORD BT 575004, APPROACHED BY POPULAR FORCES LEADER AT GATE TO OF TRUNG AN (2). P.F. LEADER WAS TRYING TO GIVE INFORMATION ON VC. COULD NOT UNDERSTAND, OTHER THAN FIVE VC ARMED WITH THREE CARBINES.

7. NONE
8. NONE
9. GOOD
10. NONE

/s/K. D. Harmon  
K. D. HARMON  
Cpl USMC

DECLASSIFIED

Encl # 29

DECLASSIFIED

LIMA  
CHU LAI  
041800H AUG 1965  
TOD: 031300H  
TOR: 031605H

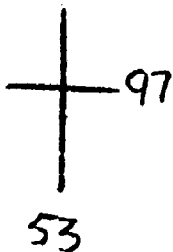
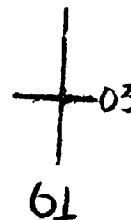

DECLASSIFIED

DECLASSIFIED

PATROL REPORT  
(#1 OF 4 AUGUST 1965)

MIKE  
CHU LAI  
061800H AUG 1965

RECON PATROL

SERIES L701, SHEET 6757 III

1. 3RD SQUAD, 2ND PLATOON, COMPANY "M", 3/3
2. OBSERVE AREA FOR V.C. ACTIVITY.
3. 040100H
4. 040215H
5. SEE OVERLAY
6. NONE
7. NONE
8. NONE
9. GOOD
10. NONE

/s/D. R. McMani  
D. R. MCMANI  
Cpl USMC

DECLASSIFIED

Encl #30

DECLASSIFIED

MISE  
CHU LAI  
061800H AUG 1965  
TOD: 040100H  
TOR: 040215H

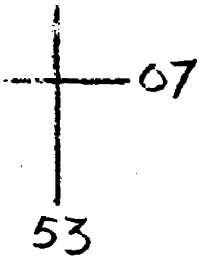
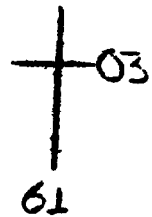

DECLASSIFIED

DECLASSIFIED

PATROL REPORT  
(#2 OF 4 AUGUST 1965)

INDIA  
CHU LAI  
061800H AUG 1965

RECON/AMBUSH PATROL

SERIES L701, SHEET 6757 III

1. 3RD SQUAD, 2ND PLATOON, COMPANY "I", 3/3
2. RECON/AMBUSH PATROL
3. 040130H
4. 040310H
5. SEE OVERLAY
6. NONE
7. NONE
8. NONE
9. GOOD
10. NONE

/s/C. Enos  
C. ENOS  
Cpl USMC

DECLASSIFIED

Encl # 21

— 02  
|  
53



INDIA  
061800H AUG 1965  
TOD: 040130H  
TOR: 040310H

— 94  
|  
57

DECLASSIFIED

PATROL REPORT  
(#3 OF 4 AUGUST 1965)

LIMA  
CHU LAI  
061800H AUG 1965

RECON/LAYOUT PATROL

SERIES L701, SHEET 6757 III

1. 2ND FIRETEAM, 2nd SQUAD, 2ND PLATOON, COMPANY "L", 3/3
2. TO OBSERVE AND TO ENGAGE THE ENEMY IF SIZE AND COMPOSITION PERMITS
3. 040300H
4. 040630H
5. SEE OVERLAY
6. NONE
7. NONE
8. NONE
9. GOOD
10. NONE

/s/M. A. Lamb  
M. A. LAMB  
LCpl USMC

DECLASSIFIED

Encl 32



DECLASSIFIED

LIMA  
CHU LAI  
061800H AUG 1965  
TOD: 040300H  
TOR: 040630H

04  
59

L-10-LAYOUT  
#1

98  
55

DECLASSIFIED

DECLASSIFIED

PATROL REPORT  
(#4 OF 4 AUGUST 1965)

INDIA  
CHU LAI  
061800H AUG 1965

RECON/COMBAT PATROL

SERIES L701, SHEET 6757 III

1. 3RD PLATOON, COMPANY "I", 3/3
2. COMBAT/RECON PATROL
3. 040600H
4. 041035H
5. SEE OVERLAY
6. NONE
7. NONE
8. NONE
9. GOOD
10. NONE

/s/J. P. Elgas  
J. P. ELGAS  
1/Lt USMC

DECLASSIFIED

*Cmel #33*

LIMA  
CHU LAI  
061800H AUG 1965  
TOD: 040600H  
TOR: 041035H

53 02

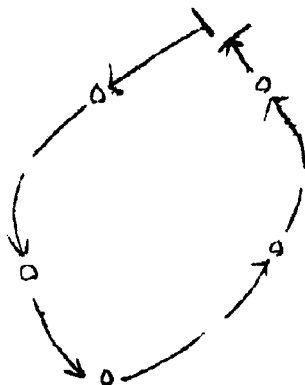

57 94

DECLASSIFIED

PATROL REPORT  
(#5 OF 4 AUGUST 1965)

LIMA  
CHU LAI  
061800H AUG 1965

RECON/COMBAT PATROL

SERIES L701, SHEET 6757 III

1. 2ND PLATOON, COMPANY "L", 3/3
2. RECON/COMBAT PATROL
3. 040705H
4. 040930H
5. SEE OVERLAY
6. NONE
7. NONE
8. NONE
9. GOOD
10. NONE

/s/H. Shimabukuro  
E. SHIMABUKURO  
SSgt USMC

DECLASSIFIED

Encl #34

LIMA  
CHC LAX  
061800H AUG 1965  
TOD: 040705H  
TOR: 040930H

03  
55



98  
60

DECLASSIFIED

PATROL REPORT  
(#6 OF 4 AUGUST 1965)

H&S  
CHU LAI  
061800H AUG 1965

RECON/COMBAT PATROL

SERIES L701, SHEET 6757 III

1. 1 SQUAD FROM 106 PLATOON, H&S COMPANY, 3/3
2. RECON/COMBAT PATROL
3. 041200H
4. 041617H
5. SEE OVERLAY
6. AT 1505H, VIC COORD BT 551038, TWO WELL TRAVELED TRAILS WITH FRESH FOOT PRINTS RUNNING IN GENERAL DIRECTION OF HIGHWAY # 1.
7. NONE
8. NONE
9. GOOD
10. I RECOMMEND THAT THE TWO WELL TRAVELED TRAILS RUNNING IN GENERAL DIRECTION OF HIGHWAY # 1 BE THE SUBJECT OF LAYOUT PATROLS EARLY MORNING OR EVENING.

/s/R. A. Moss  
R. A. MOSS  
Sgt USMC

DECLASSIFIED

*Encl 35*

DECLASSIFIED

H&S COMPANY  
CHU LAI  
061800H AUG 1965  
TOD: 041200H  
TOR: 041617E

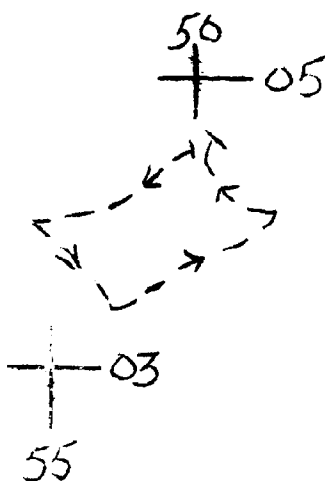

DECLASSIFIED

DECLASSIFIED

PATROL REPORT  
(#7 OF 4 AUGUST 1965)

MIKE  
CHU LAI  
061800H AUGUST 1965

RECON/COMBAT

SERIES L701, SHEET 6757 II

1. 1ST SQUAD, 3RD PLATOON, COMPANY "M", 3/3
2. OBSERVE MEVEMENT ON BEACH WHERE LVT WAS DISABLED BY MINE.
3. 040300H
4. 040600H
5. SEE OVERLAY
6. NONE
7. NONE
8. NONE
9. GOOD
10. TIME ALLOTTED FOR DISTANCE COVERED SHOULD BE MORE AS TO BE BETTER ABLE TO ACCOMPLISH MISSION - OBSERVATION TIME SHOULD BE LONGER.

/s/E. C. Youmaus  
E. C. YOUMAUS  
Sgt USMC

DECLASSIFIED

Encl #36



DECLASSIFIED

FILE  
CHU LAI  
061800H AUGUST 1965  
TOD: 040300H  
TOR: 040600H

04 + 57  
57



+ 01  
60

DECLASSIFIED

DECLASSIFIED

PATROL REPORT  
(#1 OF 5 AUGUST 1965)

H&S COMPANY  
071800H AUGUST 1965

RECON PATROL

SERIES L701, SHEET 6757 III

1. 10 MEN, (ALL PLATOONS), H&S COMPANY, 3/3
2. RECON OVERLAY ROUTE AND OBSERVE ANY ENEMY ACTIVITY
3. 051030H
4. 051440H
5. SEE OVERLAY
6. NONE
7. NONE
8. NONE
9. GOOD
10. NONE

/s/R. A. Moss  
R. A. MOSS  
Sgt USMC

Encl #37

DECLASSIFIED

H&S COMPANY  
CHU LAI  
071800H AUGUST 1965  
TOD: 051030H  
TOR: 051440H

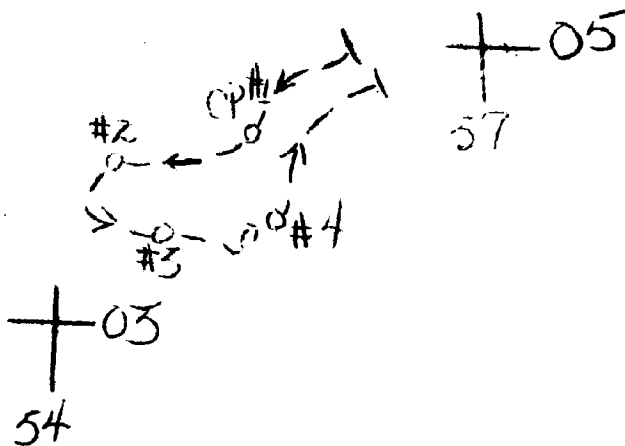

DECLASSIFIED

PATROL REPORT  
(#1 OF 8 AUGUST 1965)

MIKE  
CHU LAI  
101800H AUG 65

RECON/COMBAT PATROL

SERIES L701, SHEET 6757 II, III

1. 3RD SQUAD, 2ND PLATOON, COMPANY "M", 3/3
2. OBSERVE AREA FOR ENEMY
3. 080300H
4. 080500H
5. SEE OVERLAY
6. NONE
7. NONE
8. NONE
9. GOOD
10. NONE

/s/D. R. G. McMann  
D. R. G. MCMANN  
Cpl USMC

DECLASSIFIED

Encl #38

DECLASSIFIED

MIKE  
CHU LAI  
101800H AUG 65  
TOD: 080300H  
TOR: 080500H

04  
57  

01  
60

DECLASSIFIED

PATROL REPORT  
(#2 ON 8 AUGUST 1965)

P. A.  
GEN LAM  
101800Z AUG 65

RECON/COMBAT PATROL

SERIES L701, SHEET 6757 III

1. 1ST PLATOON, COMPANY "I", 3/3
2. RECON/COMBAT PATROL OF OVERLAY ROUTE
3. 080600Z
4. 081000Z
5. SEE OVERLAY
6. NONE
7. NONE
8. NONE
9. GOOD
10. SOME THOROUGH SEARCHES OF VILLAGES IN OUR PATROL AREAS. VILLAGES SEARCHED WEEKS AGO, SEARCHED AGAIN BY HAVING SHORTER ROUTES, SPENDING MORE TIME IN VILLAGES.

/s/J. P. Coursey Jr.  
J. P. COURSEY JR.  
1/Lt USMC

INDIA  
GEN LAI  
101800H AUG 65  
TOB: 080600H  
TOR: 081000H

02  
53

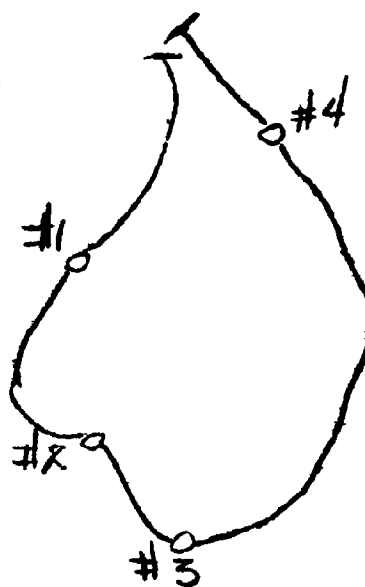

97  
57

DECLASSIFIED

PATROL REPORT  
(#3 OF 8 AUGUST 1965)

LIMA  
CHU LAI  
101800H AUG 65

**RECON/COMBAT PATROL**

SERIES L701, SHEET 6757 III

1. 3RD PLATOON, COMPANY "L", 3/3
2. RECON/COMBAT PATROL OF OVERLAY ROUTE
3. 080715H
4. 081030H
5. SEE OVERLAY
6. NONE
7. WE SAW AND SEARCHED THE SAME FOUR WELL DRESSED YOUNG MEN THAT WE HAVE SEEN ON PREVIOUS PATROL ENTERING HOA VAN # 2 FROM DIRECTION OF ROUTE #1. INDIVIDUALS WERE VERY COOPERATIVE IN SHOWING THEIR IDENTIFICATION. THEY WERE VERY CLEAN AND DID NOT LOOK LIKE LOCAL VIETNAMESE.
8. NONE
9. GOOD
10. I RECOMMEND A PLATOON BE SENT TO TRUNG AN # 1 AND # 2 ON A TWO DAY AND NIGHT PATROL REGULARLY AND SPEND THE DAYS WITH THE PEOPLE AND THE NIGHTS ON PATROLS AND LAYOUTS AROUND THE VICINITY OF COORD (BS 596996) (BT 594002), (BT 606006) AND (BT 576002) ALSO IN THE DONG BINH (1) AREA. IT IS MY CONCLUSION THAT THE PEOPLE OF TRUNG AN WANT TO BE OUR FRIENDS BUT NEED ENCOURAGEMENT.  
I ALSO RECOMMEND THAT THE FOUR WELL DRESSED INDIVIDUALS BE INTERCEPTED BY A PATROL AND AN INTERPRETER TO SEE WHAT THEIR STATUS IS.

/s/L. Moore  
L. MOORE  
SSgt USMC

DECLASSIFIED

Encl #40



03  
55

LIMA  
CHU LAI  
101800H AUG 65  
TOD: 080715H  
TOR: 081030H



98  
60

DECLASSIFIED

PATROL REPORT  
(#4 OF 8 AUGUST 1965)

MIKE  
CHU LAI  
101800H AUG 65

SPECIAL SEARCH PATROL

SERIES L701, SHEETS 6757 II, III

1. 3RD SQUAD, 3RD PLATOON, COMPANY "M", 3/3
2. RECON BEACH TO SONG TRA BONG AND CHECK IDENTIFICATION OF ANY VN COM ROUTE.
3. 080850H
4. 081050H
5. FROM COORD (BT 595032) TOWARDS SONG TRA BONG FOR APPROX 600 METERS  
ALONG WOOD LINE .
6. NONE
7. NONE
8. NONE
9. GOOD
10. NONE

/s/R. L. Holland  
R. L. HOLLAND  
Cpl USMC

DECLASSIFIED

Encl 41

DECLASSIFIED

PATROL REPORT  
(#5 OF 8 AUGUST 1965)

MIKE  
CHU LAI  
101800H AUG 65

SPECIAL SEARCH PATROL

SERIES L701, SERIES 6757 II, III

1. 1ST SQUAD, 2ND PLATOON
2. TO SEARCH OUT FISHING BOATS ON TWO LVT AT MOUTH OF SONG TRA BONG RIVER.
3. 080900H
4. 081100H
5. FROM COORD (BT 595023) SOUTH EAST TO SONG TRA BONG RIVER
6. NONE
7. SEARCHED OUT FIVE FISHING JUNKS AND FOUND NO ARMS, AMMO, ETC. CHASED TWO VC SUSPECTS IN BASKET BOAT. SUSPECTS IN BASKET BOATS LANDED ON SHORE AND GOT AWAY.
8. NONE
9. GOOD
10. NONE

/s/J. R. Smith  
J. R. SMITH  
Sut USMC

DECLASSIFIED

End 42

DECLASSIFIED

PATROL REPORT  
(#6 OF 8 AUGUST 1965)

MIKE  
CHU LAI  
101800H AUG 65

SPECIAL SEARCH PATROL

SERIES L701, SHEETS 6757III, II

1. 2ND SQUAD, 1ST PLATOON, COMPANY "M", 3/3
2. TO SEARCH FISHING BOATS ON THE SONG TRA BONG RIVER
3. 081100H
4. 081300H
5. FROM COORD (BT 595023) SOUTH EAST TO SONG TRA BONG RIVER
6. CHECKED APPROXIMATELY 100 BOATS, FINDING ONE (1) PONCHO AND ONE (1) SHELTER HALF.

ONE SUSPECT WAS WEARING UTILITY TROUSERS AND HAD A UTILITY JACKET IN HIS BOAT.

7. NONE
8. NONE
9. GOOD
10. NONE

/s/C. Lynn  
C. LYNN  
Sgt USMC

DECLASSIFIED

Encl #93

PATROL REPORT  
(#7 OF 8 AUGUST 1965)

MIKE  
CHU LAI  
101800H AUG 65

SPECIAL SEARCH PATROL

SERIES L701, SHEETS 6757 II, III

1. 2ND SQUAD, 2ND PLATOON, COMPANY "M", 3/3
2. SEARCH HARBOR FOR VC AND ALL BOATS ALONG RIVER.
3. 081300H
4. 081600H
5. FROM COORD (BT 595023) SOUTH EAST TO SONG TRA BONG RIVER
6. NONE
7. NONE
8. NONE
9. GOOD
10. THE PATROL SEARCHED A TOTAL OF 55 BOATS. AFTER THE FIRST TWO BOATS WERE STOPPED, AT OUR COMMAND, THE OTHER BOATS STOPPED WITHOUT ANY TROUBLE OR SIGNAL TO DO SO.

/s/O. L. Rush  
O. L. RUSH  
Sgt USMC

DECLASSIFIED

PATROL REPORT  
(#3 OF 8 AUGUST 1965)

MIKE  
CPT LAI  
101800H AUG 65

RECON/LAYOUT PATROL

SERIES L701, SHEET 6757 III

1. 3RD SQUAD, 1ST PLATOON, COMPANY "M", 3/3
2. RECON OF OVERLAY ROUTE AND LAYOUT AT PRE-DESIGNATED SPOT
3. 082000H
4. 082300H
5. SEE OVERLAY
6. NONE
7. NONE
8. NONE
9. FOOD
10. NONE

/s/W. J. Nichole  
W. J. NICHOLE  
Cpl USMC

DECLASSIFIED

Panel # 45

MIKE  
CHU LAI  
101800H AUG 65  
TOD: 002000H  
TCR: 082300H

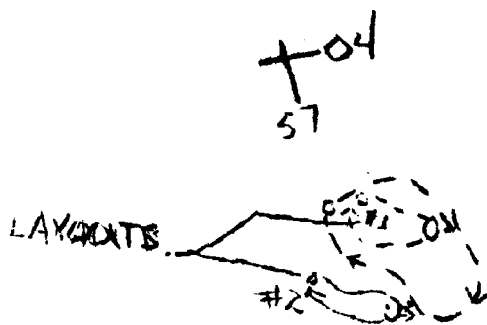

+ 01  
60

DECLASSIFIED

PATROL REPORT  
(#9 OF 8 AUGUST 1965)

H&S COMPANY  
CHU LAI  
101800 AUG 65

RECON PATROL

SERIES L701, SHEET 6757 III

1. (4) MAN FIRETEAM, 106 PLATOON, H&S COMPANY, 2/3
2. RECON OF OVERLAY ROUTE
3. 080755H
4. 080935H
5. SEE OVERLAY
6. NONE
7. NONE
8. NONE
9. GOOD
10. NONE

/s/C. Ankton  
C. ANKTON  
Cpl USMC

DECLASSIFIED

*End #46*



H&S COMPANY  
CHU LAI  
101800H ATK- 65  
TOD: 080755H  
TOR: 080935H

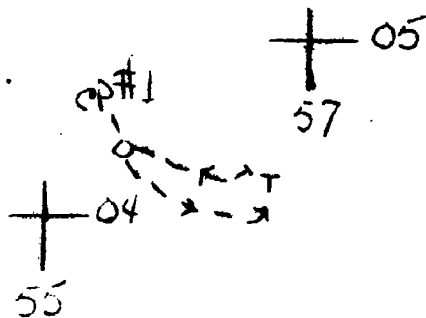

DECLASSIFIED

PATROL REPORT  
(#1 OF 9 AUGUST 1965)

MIKE  
CHU LAI  
111800H AUG 65

COMBAT PATROL

SERIES L701, SHEET 6757 III

1. 1ST SQUAD, 1ST PLATOON, COMPANY "M", 3/3
2. NIGHT COMBAT PATROL ALONG OVERLAY ROUTE
3. 092100H
4. 092330H
5. SEE OVERLAY
6. NONE
7. NONE
8. NONE
9. GOOD
10. NONE

/s/E. L. Longstaff  
E. L. LONGSTAFF  
Cpl USMC

DECLASSIFIED

Encl # 47

MIKE  
CHU LAI  
111800H AUG 65  
TOD: 092100H  
TOR: 092330H

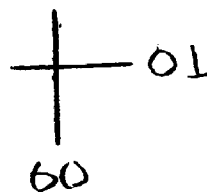
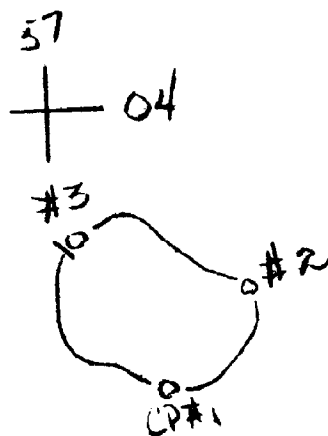

DECLASSIFIED

PATROL REPORT  
(#2 OF 9 AUGUST 1965)

H&S COMPANY  
CHU LAI  
111800H AUG 65

RECON PATROL

SERIES L701, SHEET 6757 III

1. 1 SQUAD, 106 PLATOON, H&S COMPANY, 3/3
2. RECON OF OVERLAY ROUTE
3. 090630H
4. 091000H
5. SEE OVERLAY
6. AT 0845H, COORD (BT 551030) HEARD ONE SHOT OF A SMALL CALIBER WEAPON.
7. NONE
8. NONE
9. GOOD
10. RECOMMEND THAT THE PATROL BE SENT OUT A LITTLE EARLIER.

/s/A. J. Anisly  
A. J. ANISLY  
Cpl USMC

DECLASSIFIED

Encl #48

H&S COMPANY  
111800H AUG 65  
TOD: 090630H  
TOR: 091000H

06  
55

CP# 01  
\*20\*  
\*3

00  
53

PATROL REPORT  
(#3 OF 9 AUGUST 1965)

INDIA  
CHU LAI  
111800H AUG 65

RECON/COMBAT PATROL

SERIES L701, SHEET 6757 III, 6756 IV

1. 1ST PLATOON, COMPANY "I", 3/3
2. RECON/COMBAT PATROL ALONG OVE LAY ROUTE
3. 090700H
4. 091400H
5. SEE OVERLAY
6. NONE
7. GOOD TRAILS LEADING WEST FROM VILLAGES ON WEST SIDE OF RICE PADDY INTO HIGHER, UNDER GROWN HILLS.
8. NONE
9. GOOD
10. NONE

/s/J. P. Coursey, Jr.  
J. P. COURSEY, JR.  
1/Lt. USMC

INDIA  
CHU LAI  
111800H AUG 65  
TOD: 090700H  
TOR: 091400H

03  
54



97  
58

DECLASSIFIED

PATROL REPORT  
(#4 OF 9 AUGUST 1965)

MIKE  
CHU LAI  
111800H AUG 65

COMBAT PATROL

SERIES L701, SHEET 6757 III

1. 1ST SQUAD, 2ND PLATOON, COMPANY "M", 3/3
2. SEARCH OUT ANY ENEMY OR SUSPECTED ENEMY ON ROUTE OF PATROL
3. 090830H
4. 091211H
5. SEE OVERLAY
6. NONE
7. CHECKED TOTAL OF 12 MEN FOR I.D. CARDS, ALL PRODUCED SAID CARDS.  
FOUND 55 GALLON DRUM OF GAS AT COORD (BT 588025), 100 METERS ON  
RIGHT FLANK OF OUT POST.
8. NONE
9. GOOD
10. NONE

/s/J. R. Smith  
J. R. SMITH  
Sgt USMC

DECLASSIFIED

med#50



MIKE  
CHU LAI  
111800H AUG 65  
TOD: 090830H  
TOR: 091211H

+ 04  
57

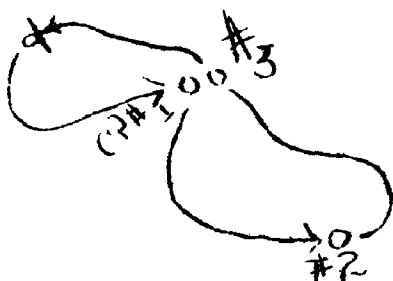

+ 01  
60

DECLASSIFIED

PATROL REPORT  
(#5 OF 9 AUGUST 1965)

INDIA  
CHU LAI  
111800H AUG 65

AMBUSH PATROL

SERIES L701, SHEET 6757 III

1. 2ND PLATOON COMPANY "I", 3/3
2. AMBUSH PATROL
3. 092200H
4. 100800H
5. SEE OVERLAY
6. NONE
7. P.F. LOCATED AT COORD (BS 565999) OPENED FIRE ON US AT 2240H. AT 0425H, DRUMS WERE HEARD COMING FROM VICINITY OF COORD (BS 582976).
8. NONE
9. GOOD
10. I RECOMMEND THAT PLATOON SIZE PATROLS BE DISCONTINUED AT NIGHT INFAVOR OF AT MOST A REINFORCED SQUAD. A SQUAD COULD MANUEVER BETTER AND EASIER WITH LESS CONFUSION. NIGHT PATROLS SHOULD GO NO FURTHER THAN 2000 METERS IN FRONT OF MLR. NIGHT PATROLS SHOULD LAST NO MORE THAN 4 HOURS.

/s/J. P. Cooney  
J. P. COONEY  
2/Lt. USMC

DECLASSIFIED

Encl #51

INDIA  
CHU LAI  
111800H AUG 65  
TOD: 092200H  
TOR: 300800H

04  
54

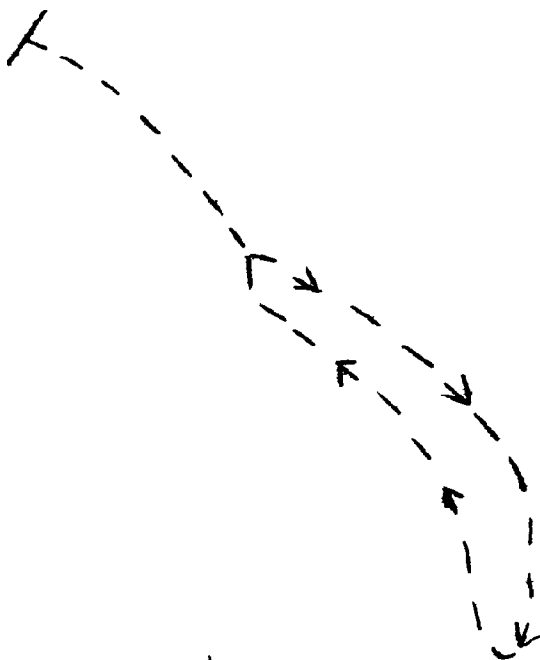

97  
56

DECLASSIFIED

PATROL REPORT  
(#1 OF 10 AUGUST 1965)

H&S COMPANY  
CHU LAI  
121800H AUG 65

RECON/COMBAT

SERIES 1701, SHEET 6757 III

1. 12 MEN, 100 PLATOON, H&S COMPANY, 3/3
2. RECON/COMBAT PATROL OF OVERLAY ROUTE.
3. 100630E
4. 100935H
5. SEE OVERLAY
6. AT 0800E, VIS COORD (BT 55230360), DISCOVERED BAMBOO COVERED BUNKER (PROBLE)
7. NONE
8. NONE
9. GOOD
10. PATROL SHOULD BE IN POSITION BY DAYBREAK AROUND THE VILLAGE (BT 5523-0360). TRACKS INDICATED PEOPLE WERE THERE EARLIER.

/s/C. Ankton  
C. ANKTON  
Cpl USMC

DECLASSIFIED

Encl #52

H&S COMPANY  
CHU LAI  
121800E A39 55  
TOD: 100630E  
TOR: 100935H

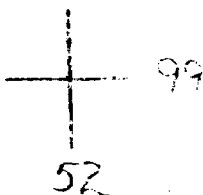
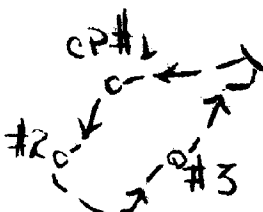
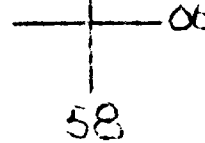

DECLASSIFIED

PATROL REPORT  
(#2 OF 10 AUGUST 1965)

INDIA  
CHU LAI  
121800H AUG 65

RECON/COMBAT PATROL

SERIES L701, SHEET 6757 III

1. 1ST PLATOON, COMPANY "I", 3/3
2. RECON/COMBAT PATROL OF OVERLAY ROUTE
3. 100800H
4. 101230H
5. SEE OVERLAY
6. AT 0840H, VIC COORD (BT 541010), GOOD TRAIL TO THIS POINT FROM WEST SIDE OF 3/3 MLR.  
  
AT 0900H, VIC COORD (BT 543004), TRAIL JUNCTION.  
  
AT 0945H, VIC COORD (BS 545994), LWT TRAIL TO HILL TOP.  
  
AT 1030H, VIC COORD (BS 547988), TRAIL JUNCTION INTO WEST SIDE OF TRI BINH (1).  
  
AT 1130H, VIC COORD (BS 555988), TRI BINH (1) - PEOPLE NORMAL
7. WELL DEFINE TRAILS IN BEHIND TRI BINH (1). NO FORDS OBSERVED ACROSS RIVER RUNNING WEST TO EAST, EXCEPT IN FRONT OF TRI BINH (1). GOOD BLOCKING POSITION OR AMBUSH SIGHT ON WEST SIDE OF TRI BINH (1), VIC COORD (BS 548987).
8. NONE
9. GOOD
10. NONE

/s/J. P. Coursey, Jr.  
J. P. COURSEY, JR.  
1/Lt. USMC

DECLASSIFIED

Encl # 53

53 04

INDIA  
CEU LAI  
121800H AUG 65  
TOD: 100800H  
TOR: 101230H

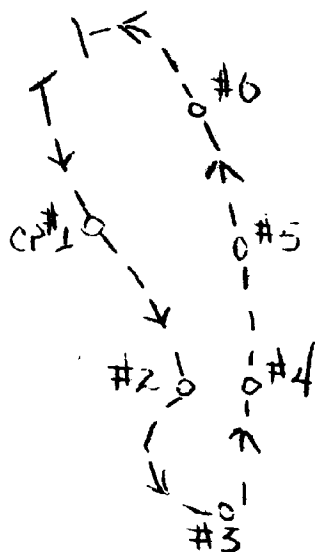

57 97

DECLASSIFIED

PATROL REPORT  
(#3 OF 10 AUGUST 1965)

INDIA  
CPT LAI  
121800H AUG 65

RECON PATROL

SERIES L701, SHEET 6757 III

1. 3RD PLATOON, COMPANY "I", 3/3
2. RECON PATROL AND ORIENTATION
3. 100830H
4. 101130H
5. SEE OVERLAY
6. NONE
7. PATROL DESIGNED TO FAMILIARIZE PLATOON WITH SURROUNDING AREA. AT APPROXIMATELY 1015H, TALKED WITH SWAIN 6, EXPLAINED NATURE OF MISSION, AT OUTPOST # 1, COORD (PT 543012).
8. NONE
9. NONE
10. NONE

/s/J. Pinguet  
J. PINGUET  
SSgt USMC

Encl 54

DECLASSIFIED



INDIA  
CHU LAI  
121800H AUG 65  
TOD: 100830H  
EPR: 101130H

05  
54



98  
58

PATROL REPORT  
(#4 OF 10 AUGUST 1965)

MIKE  
CHU LAI  
121800H AUG 65

RECON PATROL

SERIES L701, SHEET 6757 III

1. 3RD SQUAD, 1ST PLATOON, COMPANY "M", 3/3
2. PATROL ASSIGNED AREA BEHIND COMPANY POSITIONS.
3. 100930H
4. 101200H
5. SEE OVERLAY
6. NONE
7. NONE
8. NONE
9. NONE
10. NONE

/s/W. J. Nichole  
W. J. NICHOLE  
Cpl USMC

MIKE  
CHU LAI  
121800H AUG 65  
SCD: 100930H  
TOR: 101200H

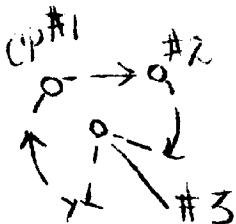

+ 02  
53

+ 02  
55

DECLASSIFIED

PATROL REPORT  
(#5 OF 10 AUGUST 1965)

MIKE  
CHU LAI  
121800H AUG 65

COMBAT PATROL

SERIES L701, SHEET 6757 III

1. 1ST SQUAD, 1ST PLATOON, COMPANY "M", 3/3
2. COMBAT PATROL ALONG OVERLAY ROUTE
3. 102100H
4. 102400H
5. SEE OVERLAY
6. NONE
7. NONE
8. NONE
9. NONE
10. NONE

/s/E. L. Longstaff  
E. L. LONGSTAFF  
Cpl USMC

DECLASSIFIED

Rmel 56

MIKE  
CHU LAI  
121800H AUG 65  
TOD: 102100H  
TOR: 102400H

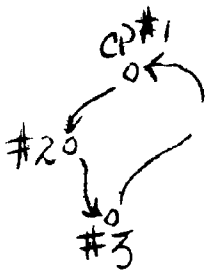

+ 04  
58

+ 02  
55

DECLASSIFIED

PATROL REPORT  
(#1 OF 11 AUGUST 1965)

H&S COMPANY  
131800H AUG 65

RECON/COMBAT PATROL

SERIES L701, SHEET 6757 III

1. 5 MEN, 106 PLATOON, H&S COMPANY, 3/3
2. RECON/COMBAT PATROL OF OVERLAY ROUTE
3. 110720H
4. 110845H
5. SEE OVERLAY
6. AT 0815H, VIC COORD (BT 56350361) TWO MEN (V.N.) CUTTING BAMBOO, TRIED TO HIDE WHEN WE CAME UPON THEM. APPREHENDED THESE TWO INDIVIDUALS AND BROUGHT THEM BACK TO SWAIN COLLECTION POINT. (FORWARDED TO AFTERGLOW COLLECTION POINT).
7. NONE
8. NONE
9. GOOD
10. NONE

/s/W. J. Hommie  
W. J. HOMMIE  
Cpl USMC

DECLASSIFIED

Encl 257

DECLASSIFIED

H&S COMPANY  
131800H AUG 65  
TOD: 110720H  
TOR: 110845H

— 07  
|  
58

#2  
12  
10  
CP#1

— 99  
|  
51

DECLASSIFIED

DECLASSIFIED

PATROL REPORT  
(#2 OF 11 AUGUST 1965)

MIKE  
CHU LAI  
131800H AUG 65

SPECIAL SWEEP PATROL

SERIES L701, SHEET 6757 II, III

1. 1ST SQUAD, 3RD PLATOON, COMPANY "M", 3/3
2. TO PATROL PLATOON FRONT AND CHECK FOR ENEMY TO OUR FRONT, ALSO CHECK FOR I.D. ON ANY VIETNAMESE PERSONS
3. 110730H
4. 111130H
5. SEE OVERLAY
6. THERE SEEMED TO BE MANY FARMERS WORKING IN THE FIELDS PAST THE BURN, MOSTLY FEMALES.
7. NONE
8. NONE
9. GOOD
10. NONE

/s/E. C. Youmaus  
E. C. YOUMAUS  
Cpl USMC

DECLASSIFIED

Encl # 58



06  
56

MIKE  
CHU LAI  
131800H AUG 65  
TOD: 110730H  
TOR: 111130H

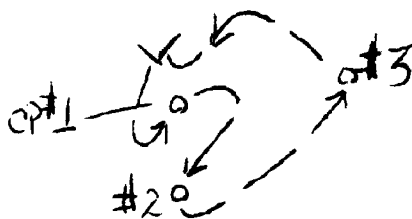

01  
61

DECLASSIFIED

PATROL REPORT  
(#1 OF 12 AUGUST 1965)

H&S COMPANY  
CHU LAI  
131800H AUG 65

RECON/COMBAT PATROL

SERIES L701, SHEET 6757 III

1. 4 MEN, 106 PLATOON, COMPANY H&S, 3/3
2. RECON/COMBAT PATROL OF OVERLAY ROUTE
3. 120730H
4. 120930H
5. SEE OVERLAY
6. NONE
7. NONE
8. NONE
9. GOOD
10. THE PATROLS THAT LEAVE EARLY IN THE MORNINGS ARE BETTER ON THE TROOPS,  
AND SHOULD REMAIN TO BE SENT OUT IN THE EARLY HOURS.

/s/G. F. Mack  
G. F. MACK  
Cpl USMC

DECLASSIFIED

Encl #59

DECLASSIFIED

H&S COMBAT  
13:00H AUG 65  
NOI: 120730H  
TOR: 120920H

00  
58

#2  
#1

00  
51

DECLASSIFIED

DECLASSIFIED

PATROL RECOMMENDATION  
(#1 OF 13 AUGUST 1965)

INDIA  
CHU LAI  
141800Z AUG 65

COMBAT/AMBUSH PATROL

SERIES L701, SHEET 6757 II, III

1. 3RD SQUAD, 2ND PLATOON, COMPANY "I", 3/3
2. COMBAT/AMBUSH PATROL
3. 130215H
4. 130645H
5. SPL OVERLAY
6. NONE
7. THERE WERE NO CHECK POINTS. THE RALLY POINT WAS OUTPOST (1).
8. NONE
9. GOOD
10. I RECOMMEND A COMBAT/AMBUSH PATROL ALONG JUNCTION OF TRAIL IN THE BIG VILLAGE APPROXIMATELY 500 METERS SOUTH OF OP #1 (TRI BIN (1)).

/s/C. R. Enos  
C. R. ENOS  
Cpl USMC

11. PATROL RECOMMENDATION IS TO BE CARRIED OUT AS A COMPANY PROJECT. PLANNED FOR 15 AUGUST 1965.

/s/B. D. Webb  
B. D. WEBB  
Capt USMC

DECLASSIFIED

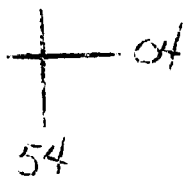

FIELD  
GEO MAP  
L1800H AUG 65  
TOB: 150215H  
TOR: 130645H

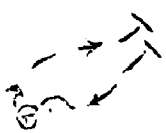

⊗-AMBUSH SITE

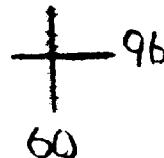

DECLASSIFIED

PATROL REPORT  
(#2 OF 13 AUGUST 1965)

H&S COMPANY  
CHU LAI  
141800H AUG 65

RECON/COMBAT PATROL

SERIES L701, SHEET 6757 III

1. 5 MEN, 106 PLATOON, H&S COMPANY, 3/3
2. RECON/COMBAT PATROL OF OVERLAY ROUTE
3. 130630H
4. 130900H
5. SEE OVERLAY
6. NONE
7. NONE
8. NONE
9. GOOD
10. NONE

/s/S. J. Romeriz  
S. J. ROMERIZ  
Cpl USMC

DECLASSIFIED

*Encl # 61*

HAS COMPANY  
CHU LAI  
141800H AUG 65  
TOD: 130630H  
TOR: 130900H

∞  
58

opt 1  
K  
# 2

∞  
52

PATROL REPORT  
(#3 OF 13 AUGUST 1965)

INDIA  
CHU LAI  
141800H AUG 65

RECON/COMBAT PATROL

SERIES L701, SHEET 6757 III

1. 3RD PLATOON, COMPANY "I", 3/3
2. RECON/COMBAT PATROL OF OVERLAY ROUTE
3. 130630H
4. 131115H
5. SEE OVERLAY
6. AT 0930H, VIC COORD (BS 555991) OBSERVED INDIGINOUS PERSONNEL CARRYING ON NORMAL WORKING ACTIVITIES IN THE FIELDS.
7. NONE
8. NONE
9. GOOD
10. NONE

/s/M. T. Benton Jr.  
M. T. BENTON JR.  
2/Lt USMC

11. PATROL ALSO HAD PURPOSE OF FAMILIARIZING NEW PLATOON WITH TAOR.

/s/B. D. Webb  
B. D. WEBB  
Capt USMC

Encl # 62



INDIA  
CHU LAI  
141800H AUG 65  
TOD: 130630H  
TOR: 131115H

+ 04  
54

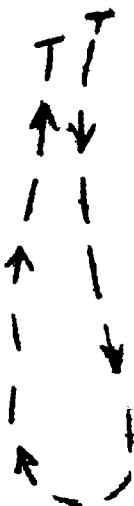

+ 98  
57

PATROL REPORT  
(#1 OF 14 AUGUST 1965)

INDIA  
CHU LAI  
161800H AUG 65

AMBUSH PATROL

SERIES L701, SHEET 6757 III

1. 2ND PLATOON, COMPANY "I", 3/3
2. AMBUSH ANY MOVEMENT ON TRAIL
3. 140100H
4. 140730H
5. SEE OVERLAY
6. NONE
7. NONE
8. NONE
9. GOOD
10. THERE ARE SEVERAL EXCELLENT AMBUSH SITES ON DUNES RUNNING PARALLEL TO MAIN TRAIL. THEY EXTEND FOR ABOUT 600 METERS SOUTH OF DONG BINH (1). THEY OFFER GOOD CONCEALMENT AND OBSERVATION OF TRAIL.

/s/J. P. Cooney  
J. P. COONEY  
1/Lt USMC

INDIA  
CHU LAI  
161800H AUG 65  
TOD: 140100H  
TOR: 140730H

03  
54

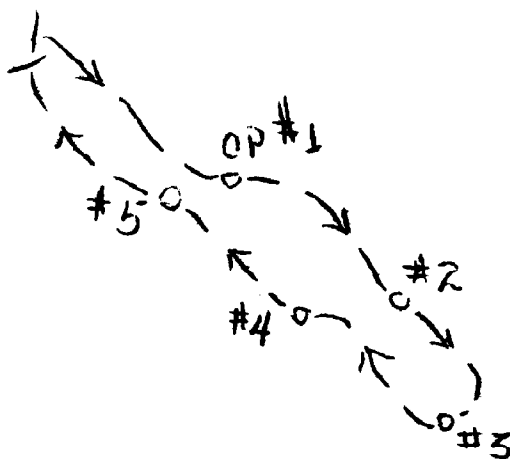

95  
51

PATROL REPORT  
(#2 OF 14 AUGUST 1965)

INDIA  
CHU LAI  
161600H AUG 65

RECON/COMBAT PATROL

SERIES L701, SHEET 6757 III

1. 3RD PLATOON, COMPANY "I", 3/3
2. RECON/COMBAT PATROL OF OVERLAY ROUTE
3. 140648H
4. 141300H
5. SEE OVERLAY
6. NONE
7. AT 0726H, VIC COORD (BT 553006) CAME UPON AN M29 TNT 4.2MM ROUND UNEXPLODED.
8. NONE
9. GOOD
10. REQUEST THAT INTERPRETER BE ATTACHED WITH PATROLS.

/s/J. Pinguet  
J. PINGUET  
SSgt USMC

11. DUD WAS WELL OUT IN OPEN IN AREA NOT USUALLY TRAVELED BY CIVILIANS.

/s/B. D. Webb  
B. D. WEBB  
Capt USMC

*Encl #64*

INDIA  
CHU LAI  
161800H AUG 65  
TOD: 140648H  
TOR: 141300H

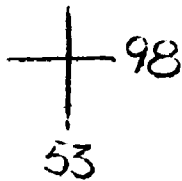
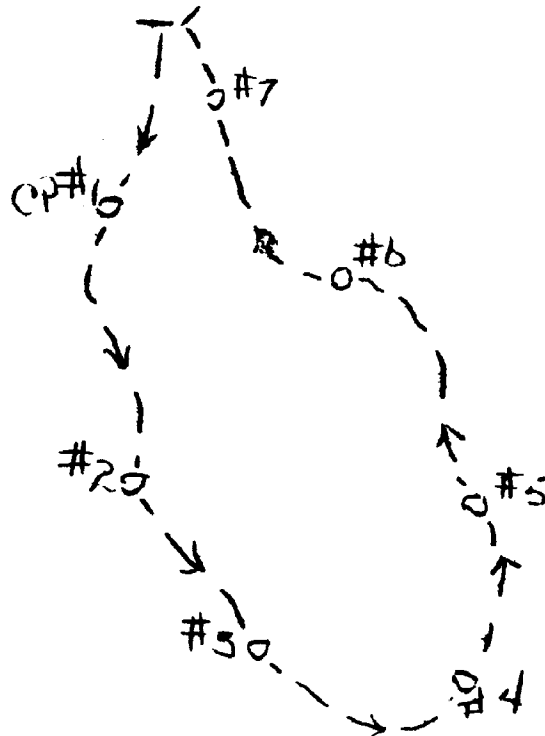
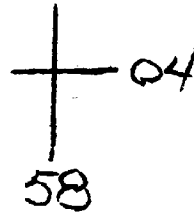

PATROL REPORT  
(#3 OF 14 AUGUST 1965)

LIMA  
CHU LAI  
161800H AUG 65

AMBUSH/LAYOUT PATROL

SERIES L701, SHEET 6757 III

1. 3RD FIRETEAM, 2ND SQUAD, 2ND PLATOON, COMPANY "L", 3/3
2. AMBUSH/LAYOUT PATROL ON OVERLAY ROUTE
3. 142000H
4. 142100H
5. SEE OVERLAY
6. NONE
7. NONE
8. NONE
9. GOOD
10. NONE

/s/J. Guturvez Jr.  
J. GUTURVEZ JR.  
LCpl USMC

11. NONE

/s/J. P. Kerchner  
J. P. KERCHNER  
1/Lt USMC

LIMP  
CHU LAI  
161800H AUG 65  
TCB: 112000H  
TOR: 112100H

+ 03  
58



+ 00  
55

⊗-AMBUSH/LAYOUT SITE

PATROL REPORT  
(#1 OF 15 AUGUST 1965)

LIMA  
CHU LAI  
171800H AUG 65

## LAYOUT PATROL

SERIES L701, SHEET 6757 III

1. 3RD SQUAD, 2ND PLATOON, COMPANY "L", 3/3
2. LAYOUT PATROL ALONG PATROL ROUTE
3. 150330H
4. 150700H
5. SEE OVERLAY
6. NONE
7. WHILE OCCUPYING OUR ASSIGNED POSITION AT COORD (BS 576992) WE COULD HEAR SMALL ARMS FIRE, INCLUDING AN AUTOMATIC WEAPON, COMING FROM THE DIRECTION OF THE TRUNG AN (2) AREA, APPROXIMATELY 800 METERS TO OUR NORTH. THIS OCCURED DURING THE HOURS OF 0500H - 0545H.
8. NONE
9. GOOD
10. NONE

/s/M. P. McAndrews  
M. P. MCANDREWS  
Cpl USMC



LIMA  
CHU LAI  
171800H AUG 65  
TOD: 150330H  
TCR: 150700H

+ 55  
03



+ 98  
60

PATROL REPORT  
(#2 OF 15 AUGUST 1965)

H&S COMPANY  
CHU LAI  
171800H AUG 65

RECON/COMBAT PATROL

SERIES L701, SHEET 6757 III

1. 5 MEN, 106 PLATOON, H&S COMPANY, 3/3
2. RECON/COMBAT PATROL ALONG OVERLAY ROUTE
3. 150730H
4. 150930H
5. SEE OVERLAY
6. NONE
7. NONE
8. NONE
9. GOOD
10. NONE

/s/A. J. Railz  
A. J. RAILZ  
Cpl USMC

DECLASSIFIED

H&S COMPANY  
CHU LAI  
171800H AUG 65  
TOD: 150730H  
TOR: 150930H

00  
58

CP#2  
10  
K  
1-9  
CP#1

00  
52

DECLASSIFIED

DECLASSIFIED

PATROL REPORT  
(#3 OF 15 AUGUST 1965)

LIMA  
CHU LAI  
171800H AUG 65

RECON/COMBAT PATROL

SERIES L701, SHEET 6757 III, 6757 II

1. 1ST PLATOON, COMPANY "L", 3/3
2. RECON/COMBAT PATROL ALONG OVERLAY ROUTE
3. 151330H
4. 151730H
5. SEE OVERLAY
6. NONE
7. NONE
8. NONE
9. GOOD
10. NONE

/s/G. R. Langford  
G. R. LANGFORD  
1/Lt USMC

DECLASSIFIED

Encl # 68

LIMA  
CHU LAI  
171800H AUG 65  
TCD: 151330H  
TOR: 151730H

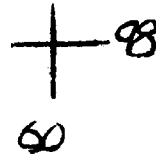
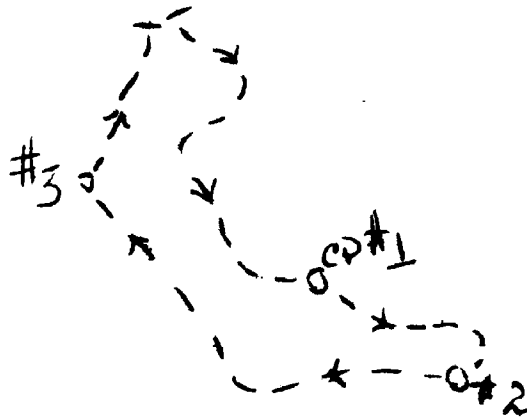
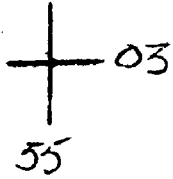

DECLASSIFIED

PATROL REPORT  
(#4 OF 15 AUGUST 1965)

LIMA  
CHU LAI  
171800H AUG 65

LAYOUT PATROL

SERIES L701, SHEET 6757 III

1. 2ND FIRETEAM, 1ST SQUAD, 2ND PLATOON, COMPANY "L", 3/3
2. LAYOUT PATROL ALONG OVERLAY ROUTE
3. 152200H
4. 152400H
5. SEE OVERLAY
6. NONE
7. NONE
8. NONE
9. GOOD
10. NONE

/s/R. J. Forrest  
R. J. FORREST  
LCpl USMC

DECLASSIFIED

Encl 69

DECLASSIFIED

LIMA  
CHU LAI  
171800H AUG 65  
TOD: 152200H  
SCR. 152400H

+ 03  
58

15  
0

+ 00  
55

@-LAYOUT SITE

DECLASSIFIED

DECLASSIFIED

PATROL REPORT  
(#1 OF 16 AUGUST 1965)

INDIA  
CHU LAI  
171800H AUG 65

COMBAT/AMBUSH PATROL

SERIES L701, SHEET 6757 III

1. 3RD SQUAD, 2ND PLATOON, COMPANY "I", 3/3
2. COMBAT/AMBUSH PATROL ALONG OVERLAY ROUTE
3. 160130H
4. 160425H
5. SEE OVERLAY
6. NONE
7. NONE
8. NONE
9. GOOD
10. NONE

/s/R. L. Noel  
R. L. NOEL  
Cpl USMC

DECLASSIFIED

Encl #78



INDIA  
CHU LAI  
171800H AUG 65  
TOD: 160130H  
TOR: 160425H

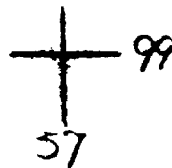
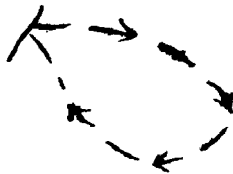
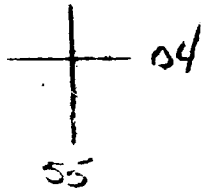

DECLASSIFIED

PATROL REPORT  
(#2 OF 16 AUGUST 1965)

INDIA  
CHU LAI  
171800H AUG 65

COMBAT/RECON PATROL

SERIES L701, SHEET 6757 III

1. 3RD PLATOON, COMPANY "I", 3/3
2. COMBAT/RECON PATROL ALONG OVERLAY ROUTE
3. 160630H
4. 161115H
5. SEE OVERLAY
6. NONE
7. NONE
8. NONE
9. GOOD
10. NONE

/s/J. Pinguet  
J. PINGUET  
SSgt USMC

DECLASSIFIED

encl 71

DECLASSIFIED

PATROL REPORT  
(#3 OF 16 AUGUST 1965)

LIMA  
CHU LAI  
171800H AUG 65

RECON/COMBAT PATROL

SERIES L701, SHEET 6757 III

1. 2ND PLATOON, COMPANY "L", 3/3
2. RECON/COMBAT PATROL OF OVERLAY ROUTE
3. 160900H
4. 161210H
5. SEE OVERLAY
6. NONE
7. STOPPED IN DONG BINH (1) AND HOE VAN (2) TO PASS OUT CIGARETTES, GUM AND MISCELLANEOUS ARTICLES.
8. NONE
9. GOOD
10. NONE

/s/J. P. Kerchner  
J. P. KERCHNER  
1/Lt USMC

DECLASSIFIED

Encl # 72

INDIA  
CHU LAI  
171800H AUG 65  
TOD: 160630H  
TOR: 161115H

+ 03  
53

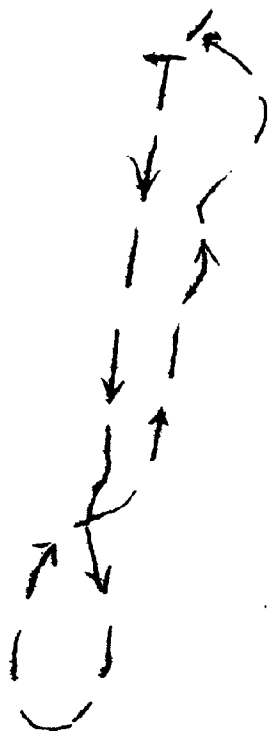

+ 98  
61

LIMA  
CHUMAI  
172800H AUG 65  
TOB: 160900H  
TOR: 151210H

03  
55

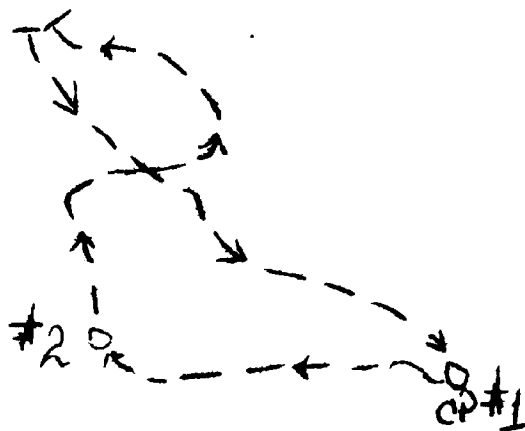

98  
60

DECLASSIFIED

PATROL REPORT  
(#4 OF 16 AUGUST 1965)

LIMA  
CHU LAI  
171800H AUG 65

RECON/COMBAT PATROL

SERIES L701, SHEETS 6757 II, III

1. 3RD SQUAD, 1ST PLATOON, COMPANY "L", 3/3
2. RECON/COMBAT PATROL TO FEEL OUT THE VILLAGERS FOR THREAT OF IMPENDING ATTACK.
3. 161130H
4. 161530H
5. SEE OVERLAY
6. NONE
7. VILLAGERS IN HOA VAN (2) WERE VERY FRIENDLY AS USUAL; SAID THEY HEARD THE SHOOTING FROM "L" COMPANY LAST NIGHT AND SO STAYED IN THEIR HOUSES; THEY HAD SEEN NO VC OR UNUSUAL PERSONS. THEY AGAIN STATED THAT THEY WOULD NOTIFY US IMMEDIATELY IF ANY VC COME INTO THEIR VILLAGE.

VN MAN IN AREA OF COORD (BT 581009) SAID THAT MARINES HAD STEPPED ON HIS CORN THREE DAYS AGO. I EXPLAINED TO HIM THAT MY MARINES TRIED TO WALK BETWEEN THE ROWS OF CROPS BUT THAT WE HAD TO KEEP SPREAD OUT IN CASE WE WERE FIRED AT. HE SEEMED SATISFIED.

8. TALKED TO PF'S IN TRUNG AN (1). THEY SAID IF THEY SHOOT A WHITE STAR CLUSTER OR PARACHUTE THIS MEANS VC ARE IN THE AREA, BUT THAT THE PF'S CAN HANDLE THE SITUATION. IF THEY SHOOT 4 RED STAR CLUSTERS, THIS MEANS THEY NEED HELP FROM THE MARINES. THEY FURTHER SAID THAT ABOUT 10 DAYS AGO THEY HAD AN ENCOUNTER WITH A PLATOON SIZE VC UNIT IN THE VICINITY OF COORD (BT 600006) THEY SAW 2 BAR'S AND 3 M-79 GRENADE LAUNCHERS ON THE VC. FREQUENTLY THEY (VC) COME TO TRUNG AN(1) AND SNIPE AT THE VILLAGE BY WAY OF THE MUONG HA MOI RIVER AND THE MUONG ONG CO RIVER IN GRID SQUARES 5900 AND 6000. THEY SAID THE VC COME FROM ACROSS THE SONG TRA BONG.
9. GOOD
10. RECOMMEND THAT AN OPERATION BE CONDUCTED TO ENCIRCLE VINH AN (1) AND (2) AND HOI NINH (1) - ROUND UP ALL YOUNG MEN AND USE THE PF'S FROM TRUNG AN (2) TO IDENTIFY THE VC. THE PF'S SAY THEY CAN IDENTIFY THEM. ALSO SOME AMBUSHES ALONG THE RIVER BANK MIGHT BE PROFITABLE.

/s/G. R. Langford  
G. R. LANGFORD  
1/Lt USMC

Encl # 7.9

DECLASSIFIED

LIMA  
CHU LAI  
171800H AUG 65  
TOD: 161130H  
TOR: 161530H

03  
55

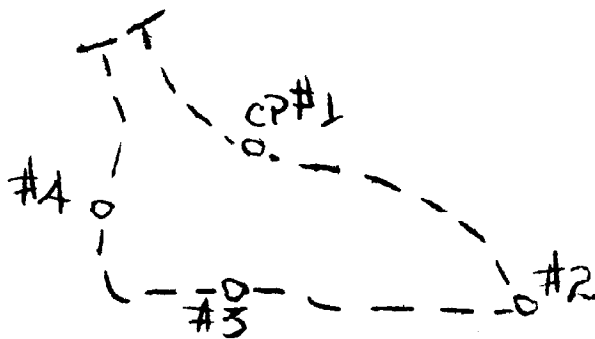

98  
60

DECLASSIFIED

PATROL REPORT  
(# OF 22 AUGUST 1965)

LIMA  
CHU LAI  
230000H AUGUST 65

AMBUSH PATROL

SERIES L701, SHEET 6757 III

1. 2ND FIRETEAM, 3RD SQUAD, 2ND PLATOON, COMPANY "L", 3/3
2. GO TO POSITION SHOWN ON OVERLAY AND OBSERVE ANY ENEMY ACTIVITY.
3. 222100H
4. 222400H
5. SEE OVERLAY
6. NONE
7. NONE
8. NONE
9. GOOD
10. NONE

/s/T. O. Howard  
T. O. HOWARD  
Col USMC

11. NONE

/s/J. P. Kerchner  
J. P. KERCHNER  
1/Lt USMC

DECLASSIFIED

Encl #74



LIMA  
CHU LAI  
231800H AUGUST 65  
TOR: 222100H  
ROR: 222400H

+ 63  
55

(6)  
↑

LAYOUT AT 1

+ 95  
79

DECLASSIFIED

PATROL REPORT  
(#1 OF 23 AUGUST 1965)

LIMA  
CHU LAI  
231800H AUG 1965

LAYOUT/AMBUSH PATROL

SERIES L701, SHEET 6757 II

1. 2ND FIRETEAM, 1ST SQUAD, 1ST PLATOON, COMPANY "L", 3/3
2. LAYOUT/AMBUSH PATROL ON OVERLAY ROUTE
3. 230100H
4. 230400H
5. SEE OVERLAY
6. NONE
7. NONE
8. NONE
9. GOOD
10. RECOMMEND THAT PRC-10 BE USED INSTEAD OF PRC-6 RADIO AS TRANSMISSIONS WERE WEAK AND GARBLED.

/s/T. P. Kavert  
T. P. KAVERT  
Cpl USMC

DECLASSIFIED

Encl #75

+ 03  
55

LIMA  
GHU LAI  
231800H AUG 65  
TOD: 230100H  
TCR: 230400H

I

LAYOUT AT 1

+ 95  
61

DECLASSIFIED

PATROL REPORT  
(#2 OF 23 AUGUST 1965)

NIKE  
CHU LAI  
231800H AUGUST 65

RECON PATROL

SERIES L701, SHEET 6757 II, III

1. 3RD PLATOON, COMPANY "M", 3/3
2. RECON AREA, CHECK PEOPLE FOR I.D.
3. 230830H
4. 231500H
5. SEE OVERLAY
6. NONE
7. NONE
8. NONE
9. GOOD
10. NONE

/s/K. Earnest  
K. EARNEST  
1/Lt USMC

Encl-476

DECLASSIFIED

+ 05  
55

MIKE  
CHU LAI  
231800H AUGUST 65  
TOD: 230830H  
TOR: 231500H

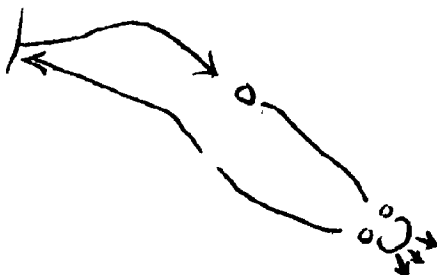

+ 01  
79

DECLASSIFIED

PATROL REPORT  
(#3 OF 23 AUGUST 1965)

LIMA  
CHU LAI  
231830H AUGUST 65

RECON PATROL

SERIES L701, SHEET 6757 III

1. 2 SQUADS, 2ND PLATOON, COMPANY "L", 3/3
2. RECON AREA IN VICINITY OF MY HUE (1) COORD (BS 613984)
3. 231100H
4. 231630H
5. SEE OVERLAY
6. NONE
7. RECEIVED ONE (1) ROUND SNIPER FIRE (BS 595975) AND INVESTIGATED. THREE MORE INCOMING ROUNDS OF UNDETERMINED ORIGIN RECEIVED AND THEN CONTINUED ON MISSION. NEGATIVE RESULTS ON INVESTIGATION.
8. NONE
9. GOOD, NO CASUALTIES.
10. RECOMMEND LONG PATROLS BE STARTED EARLIER IN DAY.

/s/J. P. Kerchner  
J. P. KERCHNER  
1/Lt USMC

DECLASSIFIED

Comel #77

03  
55

LEMA  
CHU LAI  
231800H AUGUST 1955  
FROM: 231100H  
TO: 231630E

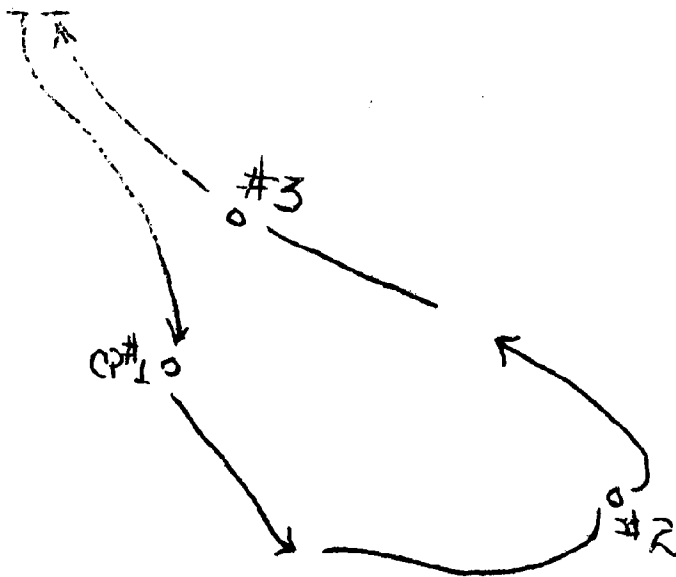

95  
04

DECLASSIFIED

PATROL REPORT  
(#4 OF 23 AUGUST 1965)

MIKE  
CHU L I  
241800H AUGUST 65

COMBAT PATROL

SERIES L 701, SHEET 6757 II, III

1. 2ND PLATOON, COMPANY "M", 3/3
2. TO MOVE TO OBJECTIVE AREA AND ESTABLISH AMBUSH.
3. 232100H
4. 240445H
5. SEE OVERLAY
6. NONE
7. DRUMS OR SIGNAL DEVICES WERE HEARD ALONG THE PATROL ROUTE, HOWEVER THERE WAS NO EVIDENCE TO INDICATE THAT THE PATROL HAD BEEN DETECTED.

WHILE RETURNING TO THE MLR (0330-0400) SEVERAL SHOTS FROM AN AUTO-MATIC WEAPON WERE HEARD NEAR THE MOUTH OF THE SONG TRA BONG RIVER.

8. NONE
9. GOOD
10. NONE

/s/F. C. Moring  
F. C. MORING  
1/Lt USMC

DECLASSIFIED

Serial # 78



MIKE  
CHU LAI  
241800H AUGUST 1965  
TOD: 232100H  
TOR: 240445H

+ 05  
55

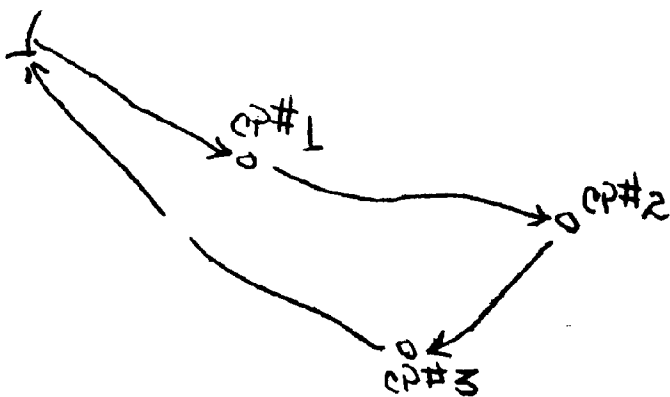

+ 00  
60

DECLASSIFIED

PATROL REPORT  
(#1 OF 24 AUGUST 1965)

LIMA  
CHU LAI  
241800H AUGUST 65

LAYOUT PATROL

SERIES L701, SHEET 6757 III

1. 3RD SQUAD, 1ST PLATOON, COMPANY "L", 3/3
2. LAYOUT ON TRAIL BEHIND HOA VAN AND AMBUSH ANY V.C.
3. 240400H
4. 240615H
5. SEE OVERLAY
6. NONE
7. NONE
8. NONE
9. GOOD
10. NONE

/s/J. O. Barber  
J. O. BARBER  
Cpl USMC

DECLASSIFIED

6-20-79

LIMA  
CHU LAI  
241800H AUGUST 65  
TOD: 240400H  
TOR: 240615H

+ 03  
55

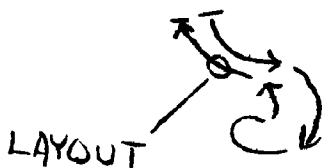

+ 95  
61

PATROL REPORT  
 (#2 OF 24 AUGUST 1965)

H&S  
 CHU LAI  
 241800H AUGUST 65

RECON PATROL

SERIES L701, SHEET 6757 III

1. SQUAD, 106 PLATOON, H&S COMPANY, 3/3
2. RECON PATROL ALONG OVERLAY ROUTE
3. 240520H
4. 241330H
5. SEE OVERLAY
6. AT 0730H, (BT 550034) PICKED UP ONE MAN, ONE BOY, ONE WOMAN- OBSERVED SEVERAL TREES CUT DOWN.  
 AT 0835H, (BT 545030) PICKED UP THREE PRISONERS.  
 AT 0920H, (BT 540027) PICKED UP FOURTEEN PRISONERS, CUTTING WOOD AND PICKING UP BRICKS.  
 AT 1030H, (BT 540035) PICKED UP TWO PRISONERS HEADING CA TITTLE AND CUTTING WOOD.  
 AT 1100H, (BT 542040) PICKED UP FIVE PRISONERS HEADING CATTLE AND CUTTING WOOD.
7. AT (BT 564040) WE BLINDFOLDED SEVEN PRISONERS BEFORE ENTERING C.P. AREA AND PLACED THEM IN BN POW COMPOUND.  
 AT 0930H TWENTY PRISONERS WERE FORWARDED TO THE AFTERGLOW COLLECTION POINT.
8. ALL POWS PICKED UP WERE BELIEVED TO BE FARMERS
9. GOOD.
10. RECOMMEND PATROLS BE STARTED EARLIER.

/s/R. C. Schneider  
 R. C. SCHNEIDER  
 Cpl USMC

H&S  
CHU LAI  
241800H AUGUST 65  
TOD: 240620H  
TOR: 241330H

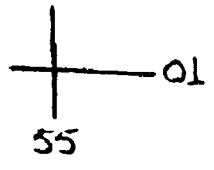
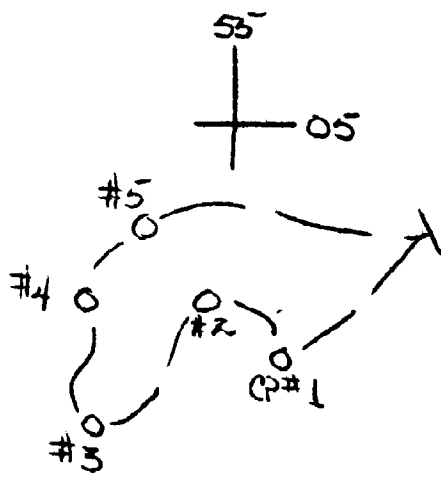

DECLASSIFIED

PATROL REPORT  
(# 3 OF 24 AUGUST 1965)

LIMA  
CHU IAN  
251800H AUGUST 65

RECON/BLOCKING FORCE

SERIES 1701, SHEET 6757 II, III

1. 1ST PLATOON, COMPANY 141, 3/3
2. RECON/COMBAT/BLOCKING FORCE
3. 241200H
4. 241930H
5. SEE OVERLAY
6. NONE
7. THE PATROL WAS CHANGED TO INCLUDE GOING DOWN TO MY HUE AND COVERING THE RIVER WHILE THE 7TH MARINES SWEEP TOWARDS US.
8. NONE
9. GOOD
10. NONE

/s/G. R. Langford  
G. R. LANGFORD  
1/Lt USMC

DECLASSIFIED

Encl # 81

LIMA  
CHU LAI  
251800H AUGUST 1965  
TOP: 241200H  
EOP: 241930H

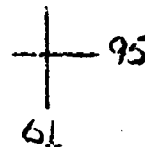
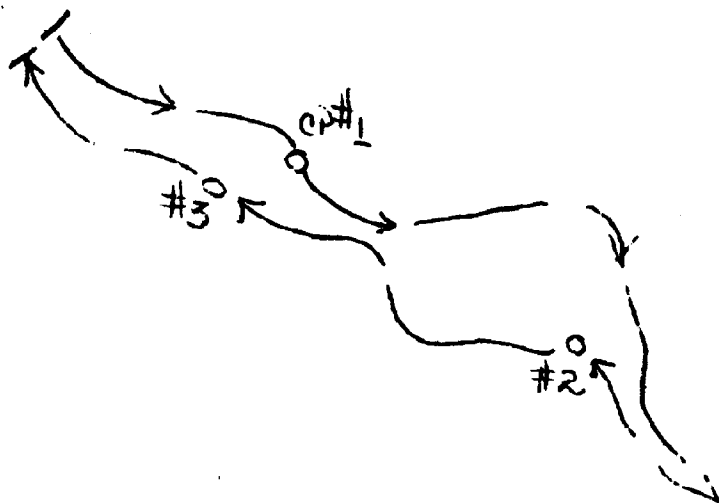
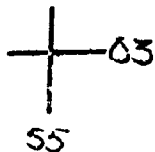

DECLASSIFIED

PATROL REPORT  
(#4 OF 24 AUGUST 1965)

MIKE  
CHU LAI  
251800H AUGUST 65

SWEEP ACTION

SERIES L701, SHEET 6757 III, II

1. 2ND PLATOON, COMPANY "M", 3/3
2. MOVE TO AND SWEEP VILLAGES OF VINH AN (1) AND (2)
3. 241320H
4. 241805H
5. MOVED PARALLEL TO BEACH OVER LOOKING BEACH AND SWEEP THROUGH VILLAGE
6. NONE
7. NOTIFIED ARTILLERY BATTERY THAT PLATOON WOULD BE WORKING IN THE AREA.  
INDIGINOUS PERSONNEL WERE RECEPTIVE  
MANY HOUSES HAD REPUBLIC OF VIETNAM FLAGS HANGING OUTSIDE.  
CONCRETE BRIDGE BEING CONSTRUCTED AT BT 614004  
VINH AN (1) AND (2) SURROUNDED BY BARBED WIRE AND BAMBOO FNECE
8. NONE
9. GOOD
10. THE PEOPLE OF THIS VILLAGE, ESPECIALLY CHILDREN ARE IN NEED OF MEDICAL CARE. PERHAPS IT MIGHT BE POSSIBLE TO HOLD SICK CALL THERE FROM TIME TO TIME.

/s/F. C. Moring  
F. C. MORING  
1/Lt USMC

DECLASSIFIED

*encl # 8 2*



DECLASSIFIED

PATROL REPORT  
(# 1 OF 25 AUGUST 1965)

LIMA  
CHU LAI  
251800H AUGUST 65

RECON/COMBAT PATROL

SERIES L701, SHEET 6757 III

1. 2ND PLATOON, COMPANY "L", 3/3
2. RECON/COMBAT PATROL ALONG PATROL ROUTE
3. 250400H
4. 250800H
5. SEE OVERLAY
6. NONE
7. NONE
8. NONE
9. GOOD
10. NONE

/s/J. P. Kerchner  
J. P. KERCHNER  
1/Lt USMC

DECLASSIFIED

Encl # 83

03  
55

LIMA  
CHU LAI  
251800H AUGUST 65  
TOD: 250400H  
TOR: 250800H

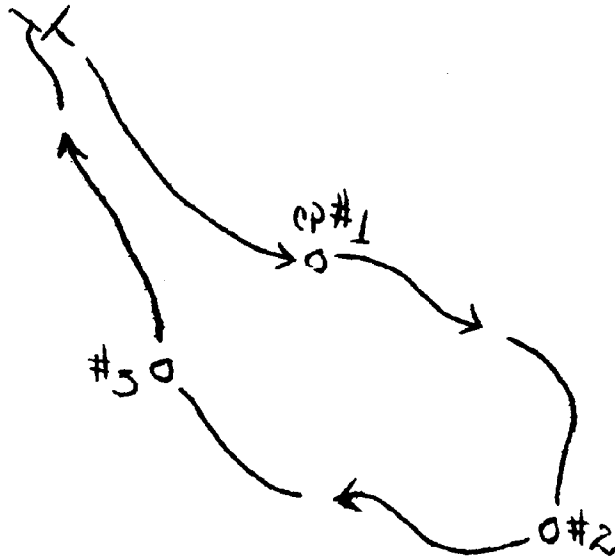

96  
61

DECLASSIFIED

PATROL REPORT  
(#2 OF 25 AUGUST 1965)

KILO  
CHU LAI  
251800H AUGUST 1965

RECON/COMBAT PATROL

SERIES L701, SHEET 6757 III

1. 1ST PLATOON, COMPANY "K", 3/3
2. TO RECON AREA FOR ENEMY, ENEMY ACTIVITY
3. 251000H
4. 251215H
5. SEE OVERLAY
6. TERRAIN - THICK BRUSH WITH SMALL SELDOM TRAVELLED TRAILS AND COVERING OVER SOME AREAS PROVIDES GOOD OVERHEAD CONCEALMENT, ESPECIALLY IN VIC OF COORD (BT 550003).
7. NONE
8. NONE
9. GOOD
10. NONE

/s/Taheda, Sgt  
TAHEDA, Sgt, USMC

DECLASSIFIED

Encl # 84

KILO  
CHU LAI  
251800H AUGUST 65  
TOD: 251000H  
TOR: 251215H

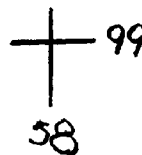
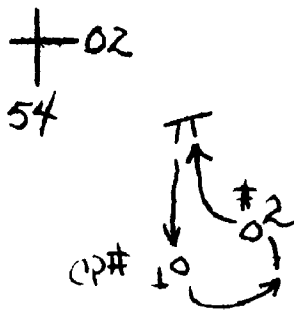

Copy #1  
 3rdBn, 3rdMar  
 Chu Lai, Vietnam  
 050800H Aug65

Periodic Personnel Report #12

Period Covered: 282400H Jul65 - 042400H Aug65

1. Strengths

- a. See PDS report period 032400H - 042400H Aug65.

2. Replacements

- a. No replacements arrived during this period.

3. Discipline, Law and Order

- a. No AWOL or deserters.
- |                                |      |
|--------------------------------|------|
| b. General Courts Martial      | None |
| Special Courts Martial         | 1    |
| Summary Courts Martial         | 1    |
| Battalion Commander's OH       | 1    |
| Pending Special Courts Martial | 1    |
| Pending Summary Courts Martial | None |

4. Prisoners of War

- a. Nothing to report.

5. Graves Registration

- a. One deceased marine was processed through our BAS during this period. There were none buried.

6. Morale and Personnel Services

- a. Morale is considered high.
- b. Personnel services are satisfactory.
- c. The mobile PX and postal unit serviced the battalion during this period, and both were utilized to the maximum. It has been noted that the items carried by the PX unit are inadequate in all respects.

7. Civil Affairs

- a. At 310615 July, a seven year old Vietnamese girl was wounded in two places by small arms fire. The wounds were inadvertently brought about as a direct result of the small girl and three other civilians being used as human shields by five Viet Cong guerrillas. One round grazed her temple leaving a one and one half inch laceration. The second round entered her left posterior thigh, and exited through her

Copy #1  
 3rdBn, 3rdMar  
 Chu Lai, Vietnam  
 050800H Aug65

supra pubic area and left medial thigh. She was treated on the spot by a corpsman and evacuated immediately to BAS. Upon arrival in BAS, the girl was further treated by the Battalion Surgeons and evacuated to "B" Med, her location at this time.

b. Several attempts were made to contact the girl's mother with eventual positive results. The contact was made on 4 August 1965 near GC 615016 by the Battalion Chaplain, who had left a note, with the local villagers in the hope that it would find its way to the girl's mother. Positive identification was made on the spot, by use of two Polaroid pictures of the child. The mother and grandmother were escorted to "B" Med and reunited with the young girl. Arrangements have been made for daily visits by the mother to "B" Med.

c. An attempt is now being made to send the girl to either Da-nang or Saigon for plastic surgery and skin grafts.

#### 8. Personnel Procedures

a. This unit is not receiving evacuation messages from the various evacuation points. This is causing discrepancies and the forwarding of personal mail.

b. The battalion has received various types of transfer orders from the Air Force hospital at Clark, Philippines. These orders are directing permanent change of station to CONUS but do not state a place of hospitalization. It is requested that the Commanding General, 3rd Marine Division, initiate correspondence to the various hospitalization points requesting they inform the Commanding General, 3rd Marine Division direct, when a patient is to be evacuated to CONUS. This would enable the division order writing section to direct/effect this move on a Division Special Order.

It is felt by the above procedures being established, it would allow the parent unit to report accurately, transfer by service record, ship personal effects and forward personal mail in a timely and expeditious manner, to the actual place the patient is to be interned.

#### 9. Interior Management

a. Nothing to report.

#### 10. Civil Employment

a. There are no civilians employed by this battalion.

Copy #1  
3rdBn, 3rdMar  
Chu Lai, Vietnam  
050800H Aug65

11. Miscellaneous

- a. Nothing to report.

BY COMMAND OF LIEUTENANT COLONEL J. E. MUIR

  
P. T. JONES

First Lieutenant, U. S. Marine Corps  
Battalion Adjutant

Copy #1  
 3rdBn, 3rdMar  
 Chu Lai, Vietnam  
 130800H Aug65

Periodic Personnel Report #13

Period Covered: 042400H - 122400H Aug65

1. Strengths

a. See PDS report period: 112400H - 122400H Aug65.

2. Replacements

a. No replacements arrived during this period.

3. Discipline, Law and Order

a. AWOL or deserters	1 returned
b. General Courts Martial	None
Special Courts Martial	None
Summary Courts Martial	None
Battalion Commander's OH	1
Pending Special Courts Martial	1
Pending Summary Courts Martial	1

4. Prisoners of War

a. There were ten VCS captured during this period, three which were VCC.

5. Graves Registration

a. One deceased marine processed through our BAS during this period. There were none buried.

6. Morale and Personnel Services

a. Morale is considered high.

b. Personnel services are satisfactory.

c. The mobile PX and postal unit serviced the battalion during this period. The items carried by the mobile PX are considered inadequate in all respects.

7. Civil Affairs

a. Medical aid is being given to the indigenous personnel located within this unit's TAOR.

b. During this period, three civilians were evacuated to the BAS for treatment and subsequent return to their villages.



Copy #1  
3rdBn, 3rdMar  
Chu Lai, Vietnam  
130800H Aug65

c. A sick call was held in the village of Hoa Van (2) by the Battalion Surgeon and approximately 100 civilians were treated. All medical treatment given was gratefully accepted.

8. Personnel Procedures

a. Nothing to report.

9. Interior Management

a. Nothing to report.

10. Civil Employment

a. There are no civilians employed by this battalion.

11. Miscellaneous

a. Nothing to report.

BY COMMAND OF LIEUTENANT COLONEL J. E. MUIR

  
P. T. JONES

First Lieutenant, U. S. Marine Corps  
Battalion Adjutant

Copy #2  
 3rdBn, 3rdMar  
 Chu Lai, Vietnam  
 201600H Aug65

Periodic Personnel Report #14

Period Covered: 122400H - 192400H Aug65

1. Strengths

a. See PDS report period: 182400H - 192400H Aug65

2. Replacements

a. No replacements arrived during this period.

3. Discipline, Law and Order

a. AWOL or deserters	None
b. General Courts Martial	None
Special Courts Martial	1
Summary Courts Martial	1
Battalion Commander's OH	1
Pending Special Courts Martial	2
Pending Summary Courts Martial	None
Pending Article 32 Investigation	1

4. Prisoners of War

a. None

5. Graves Registration

a. Seven deceased Marines processed through our BAS during this period. There were none buried.

6. Morale and Personnel Services

a. Morale is considered high

b. Personnel services are satisfactory.

c. The mobile PX and postal unit serviced the battalion during this period. The items carried by the mobile PX are considered inadequate in all respects.

7. Civil Affairs

a. Medical aid is being given to the indigenous personnel located within this unit's TAOR.

b. During this period, three civilians were evacuated to the BAS for treatment.

Encl # 89

Copy #1  
3rdBn, 3rdMar  
Chu Lai, Vietnam  
201600H Aug65

c. Sick call was held in the villages of Nam Binh and Hoa Van (2).  
Approximately 100 were treated

8. Personnel Procedures

a. Nothing to report.

9. Interior Management

a. Nothing to report.

10. Civil Employment

a. There are no civilians employed by this battalion.

11. Miscellaneous

a. Nothing to report.

BY COMMAND OF LIEUTENANT COLONEL J. E. MUIR



P. T. JONES  
First Lieutenant, U. S. Marine Corps  
Battalion Adjutant

Copy #1  
 3rdBn, 3rdMar  
 Chu Lai, Vietnam  
 261600H Aug65

Periodic Personnel Report #15

Period Covered: 192400H - 262400H Aug65

1. Strengths

a. See PDS report period: 252400H - 262400H.

2. Replacements

a. During this reporting period, this unit received 15 Navy enlisted replacements for those ordered to CONUS.

3. Discipline, Law and Order

a. AWOL or deserters	None
b. General Courts Martial	None
Special Courts Martial	None
Summary Courts Martial	None
Battalion Commander's OH	None
Pending Special Courts Martial	1
Pending Summary Courts Martial	1
Pending Article 32 Investigation	2

4. Prisoners of War. There were thirty-six prisoners taken by this unit during the reporting period.

a.

5. Graves Registration

a. 13 deceased Marines processed through our BAS during this reporting period. There were none buried.

b. 5 deceased Marines from the unit processed through B - Med. There were none buried.

c. 1 deceased Marine from the unit processed through C - Med. There were none buried.

6. Morale and Personnel Services

a. Morale is very high.

b. Personnel Services are satisfactory.

c. The mobile PX and postal unit serviced the battalion during this period. The items carried by the mobile PX are considered inadequate in all respects.

Encl # 88

Copy #1  
3rdBn, 3rdMar  
Chu Lai, Vietnam  
261600H Aug65

7. Civil Affairs
  - a. Sick call was held for approximately 400 indigenous personnel during this period.
8. Personnel Procedures
  - a. Nothing to report.
9. Interior Management
  - a. The Battalion CP is presently involved in moving to a new location. Coordinates will be given at a later date.
10. Civil Employment
  - a. There are no civilians employed by this battalion.
11. Miscellaneous
  - a. Nothing to report.

BY COMMAND OF LIEUTENANT COLONEL J. E. MUIR

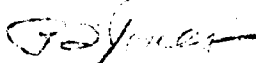

P. T. JONES

First Lieutenant, U. S. Marine Corps  
Battalion Adjutant

3rd Battalion, 3rd Marines  
 Chu Lai, Viet Nam  
 051200 H August 1965

Periodic Logistic Report No. 10-65

Period Covered: 291200 H July to 051200 H August 1965

Ref: (a) Map: Tri Binh 1:50,000 Sheet 6757-III  
 (b) CG msg 051244Z Jul 65  
 (c) CG msg 250234Z Jul 65

Encl: (1) Listing of unfilled Priority 2 and certain priority 5 Requisitions  
 (2) Ammunition expended during Period  
 (3) Increase/Decrease to Equipment Density

1. Logistical Situation at end of Period

CP Coord 564044

2. Supply

a. Supported Strength \*

	<u>Officer</u>	<u>Enlisted</u>	<u>Civilian</u>
U.S. Military	51	1122	
Allied Military	1	2	
V.C. Interned			
U.S. Civilians			
Allied Civilians			

b. Supply

(1) Unit Supplies

Class I

MCI	7500	No. of Meals
"B" Rations	4	No. of Days
"A" Rations	1	No. of Meals
Fuel Trioxane	7500	No. of Bars or Tabs

\* These figures include all personnel eating in 3/3 messes

Class II

Communications

Initial Allowance	<u>98</u> % O/H
Repair Parts	<u>20</u> No. of Days O/H
Consumables	<u>25</u> No. of Days O/H

Engineer

Initial Allowance	<u>100</u> % O/H
Repair Parts	<u>0</u> No. of Days O/H
Consumables	<u>0</u> No. of Days O/H

General Supply

Initial Allowance	<u>90</u> % O/H
Repair Parts	<u>20</u> No. of Days O/H
Consumables	<u>15</u> No. of Days O/H

Motor Transport

Initial Allowance	<u>92</u> % O/H
Repair Parts	<u>13</u> No. of Days O/H
Consumables	<u>18</u> No. of Days O/H

Ordinance

Initial Allowance	<u>98</u> % O/H
Repair Parts	<u>10</u> No. of Days O/H
Consumables	<u>0</u> No. of Days O/H

Class III

Bulk	<u>0</u> No. of Gallons Mogas
Drummed	
Mogas	<u>4</u> No. of Drums O/H
Diesel	<u>3</u> -do-
Kerosene	<u>0</u> -do-
SAE-10	<u>0</u> -do-
SAE-30	<u>4</u> -do-
GO-90	<u>1</u> -do-
GAA-3	<u>1</u> No. of 35-Lb Cans O/H
50 Wt Oil	<u>0</u> No. of Drums O/H
Solvent	<u>2</u> -do-

Class IV

Sandbags	<u>0</u> Qty O/H in Unit Supply Dump
Barbed Wire	<u>0</u> -do-
Concertina	<u>0</u> -do-
5' Fence Posts	<u>0</u> -do-
32" Fence Posts	<u>0</u> -do-
2' Fence Posts	<u>50</u> -do-
8' Fence Posts	<u>0</u> -do-

Class V - 1 DOA 3.5, 3 DOA 81mm, 1 DOA 106 RR and BA of all other

(2) Problem Supply Items

See Encl (1) for Listing

c. Local Procurement

None

d. Miscellaneous

(1) Captured Material: None

(2) Salvaged Material: None

3. Evacuation and Hospitalization

a. Evacuations

	<u>Number</u>	<u>Evacuated by</u>		<u>Awaiting</u>	<u>Returned</u>
		<u>Air</u>	<u>Surface</u>	<u>Evacuation</u>	<u>to Duty</u>
WIA	3	3	0	0	2
KIA	0	0	0	0	0
Non-Battle	5	0	5	0	7

4. Transportation

a. Highway

(1) Availability

<u>Veh Type</u>	<u>T/E Shortages</u>	<u>Deadlined</u>	
		<u>Org</u>	<u>Field</u>
M-422	0	4	1
M-38A1	0	0	0
M-274	3	0	19
M-35	0	0	0
M-37	0	0	0
M-51	0	0	0
M-54	0	0	0
M-52/M-172	0	0	0
LVTP5	0	0	0



(2) Utilization

	Log Lift	Tact Lift
Personnel	316	N/A
Cargo	2 Tons N/A CuFt	N/A Tons N/A CuFt
Total Mileage	1146	N/A

5. Service

a. Maintenance

	D/L Start	No. Repaired During Period		D/L End of Period	Avail
		Org	Field		
Communications					
PRC-6	8	19		9	27
PRC-10	7	15		9	31
PRC-41	1			1	4
PRC-47		1			5
TPS-21	2		2	2	0
PE-75	1			1	0
Engineer					
FU-348				1	0
Motor Transport					
M-422	5	5	1	5	15
M-274	17	4	3	19	8
Lube Svc Unit				1	0
Ordnance					
M-60	2	1	1	1	34
M-79	2		2	1	35
81mm	1	1	2	1	7
3.5		1			32
Flamethrower	4			4	4
106 RR	3		1	2	6

b. Construction

Project	Date Started	Per cent Completed	Estimated Completion Date
Command & OP Bunker	12Jul65	3	Unk
MLR	1Jul65	15	Unk
OPLR	1Jul65	60	Unk

6. Miscellaneous

a. Grid Coordinates of Headquarters: 564044

b. Protection Losses or damages due to: N/A

(1) Organized Enemy Action - N/A

(2) Sabotage - N/A

(3) Pilferage - N/A

(4) Natural Causes - None

(5) Measures taken to reduce such losses - None

c. Projections Logistic requirements to support anticipated/planned operations.

(1) The following additional requirements for Class IV material have been established in order to complete the MLR, OPLR and CP fortifications:

<u>Item</u>	<u>Qty</u>
Modular Shelter, Prefab 20'x40'	1
Modular Shelter, Prefab 8'x8'	26
Sandbags, ea.	575,000
Concertina, Rolls	2,250
Barbed Wire, 100 Ft. Rolls	1,200
Stakes, Metal 2'	7,800
Stakes, Metal 5'	3,900
Stakes, Metal 8'	3,900
Beams, Wooden 6"x6"x10'	450
Planks, Wooden 2"x12"x10'	1,100
Beams, Wooden 4"x4"x10'	250
Tarpaper, Rolls 30"x25 Yds.	60
Staples, Barbed Wire	11,200
Drift Pins $\frac{1}{4}$ "	450
Corrugated Tin, Sheet 30"x72"	300

d. Other Administrative Matters

(1) One additional water trailer is required to support a fourth company mess which has been established.

(2) The construction of a clay base road net throughout the 3rd Battalion, 3rd Marines area would enhance logistic support and decrease deadline rate on LVTs, Water Trailers, Trucks and Organ-  
ic Vehicles.

(3) One hundred ten General Purpose tents are still required to support planned cantonment.

BY COMMAND OF LIEUTENANT COLONEL J.E. MUIR

*H. T. Kerr*  
H. T. KERR  
Captain, U.S. Marine Corps  
S-4 Officer

DECLASSIFIED

Lists of Unfilled Priority 2  
and Certain Priority 5 Requisitions

Priority 2

<u>Date</u>	<u>NSN</u>	<u>Item</u>	<u>Qty</u>	<u>Doc No.</u>
22 May	6145 160 7795	Wire Mx306	20	04397
-do-	6145 160 7795	Wire RL159	15	04398
-do-	6140 981 9865	Tabular Storage	15	04399
-do-	6140 981 9867	Connector	30	04400
-do-	5958 282 9167	Tube 12AT7WA	2	04401
29 May	5938 222 9014	Socket Electron	1	04410
-do-	5820 291 1243	Antenna AT 272	10	04415
-do-	5820 242 4957	Antenna AT 271	10	04416
-do-	5985 724 9114	Boat Antenna	1	04440
-do-	2530 724 9117	Master Cylinder	1	04441
-do-	2920 593 6436	Magneto Rpr Kit	2	04442
-do-	2610 726 0317	Tube 750x10	6	04443
-do-	2520 761 4799	CV Joint	3	04445
30 May	2590 650 5393	Hand Crank	10	04523
1 Jun	5930 348 6750	Cover Electric Switch	2	04550
5 June	2950 531 2798	Pulley Idler	1	04600
-do-	3050 698 3158	Belt V	1	04608
8 June	2530 724 9117	Master Cylinder	1	04623
10 Jun	3110 100 0534	Cap & Bearing	1	04633
-do-	2520 761 4799	CV Joint	1	04636
-do-	2510 726 7490	Spring Assembly	2	04637
-do-	2520 764 1070	Shaft Assembly	1	04638
-do-	2510 724 9166	Spring Assembly	2	04640
12 Jun	5320 045 1063	Nut Self Locking	8	04665
-do-	5340 727 5513	Bushing Rubber	8	04674
25 Jun	4750 012 2421	Fitting Copper	50	04742
-do-	4710 350 9881	Tubing Copper	25	04743
1 July	2320 064 6513	M-274 Male	3	04779
5 July	5305 010 0021	Screw	80	00021
-do-	5320 032 0700	Lockwasher	1	00022
-do-	5305 088 5742	Bolt	40	00023
-do-	5320 012 0377	Nut	1	00024
-do-	2520 979 6549	Bracket	40	00025
-do-	2510 724 9066	Leaf Spring	3	00026
-do-	2510 726 7490	Leaf Spring	2	00027
-do-	2530 724 9117	Master Cylinder	2	00028

Priority 5

<del>23 Jun</del>	<del>6135 240 3200</del>	<del>BA 279</del>	<del>313</del>	<del>04755</del>
14 Jul	6135 240 3200	BA 279	200	00340
24 Jul	6135 240 3200	BA 279	600	00423
-do-	5960 188 6588	Tube 5672	2	00426

ENCLOSURE (1)

**AMMUNITION EXPENDITURE REPORT**

<u>DOD</u>	<u>AMOUNT EXPENDED</u>
A 130	169 rds
A 475	46 rds
B 568	2 rds
C 226	17 rds
G 895	21 rds
G 940	5 ea
L 312	8 ea
L 314	4 ea
L 495	2 ea

## Increase/Decrease to Equipment Density

<u>T/A No.</u>	<u>Old Totals</u>	<u>Increase</u>	<u>Decrease</u>	<u>New Total</u>
* 23020	1		1	0

\* This item was erroneously shown on the last equipment density report. The item has been on order but has not been received as yet.

ENCLOSURE (3)

3rd Battalion, 3rd Marines  
 Chu Lai, Viet Nam  
 121200H August 1965

Periodic Logistic Report No. 11-65

Period Covered: 051200H to 121200H August 1965

Ref: (a) Map: Tri Binh 1:50,000 Sheet 6757-III  
 (b) CG msg 051244Z Jul 65  
 (c) CG msg 250234Z Jul 65

Encl: (1) Listing of unfilled Priority 2 and certain Priority 5 Requisitions  
 (2) Ammunition expended during Period  
 (3) Increase/Decrease to Equipment Density

1. Logistical Situation at end of Period

CP Coord 564044

2. Supply

a. Supported Strength \*

	<u>Officer</u>	<u>Enlisted</u>	<u>Civilian</u>
U.S. Military	48	1061	
Allied Military	1	2	
V.C. Interned			
U.S. Civilians			
Allied Civilians			

b. Supply

(1) Unit Supplies

Class I

MCI	4284	No. of Meals
"B" Rations	4	No. of Days
"A" Rations	1	No. of Meals
Fuel Trioxane	4300	No. of Tabs or Bars

\* These figures include all personnel eating in 3/3 messes

Class II

Communications

Initial Allowance 92 % O/H  
 Repair Parts 15 No. of Days O/H  
 Consumables 30 No. of Days O/H

Engineer

Initial Allowance 98 % O/H  
 Repair Parts 0 No. of Days O/H  
 Consumables 0 No. of Days O/H

General Supply

Initial Allowance 80 % O/H  
 Repair Parts 20 No. of Days O/H  
 Consumables 15 No. of Days O/H

Motor Transport

Initial Allowance 92 % O/H  
 Repair Parts 15 No. of Days O/H  
 Consumables 15 No. of Days O/H

Ordnance

Initial Allowance 99 % O/H  
 Repair Parts 10 No. of Days O/H  
 Consumables 0 No. of Days O/H

Class III

Bulk	<u>NONE</u> No. of Gallons Mogas	
Drummed	<u>No. of Drums O/H</u>	<u>No. of Gallons Consumed</u>
Mogas	<u>13</u>	<u>600</u>
Diesel	<u>3</u>	<u>NONE</u>
Kerosene	<u>NONE</u>	<u>NONE</u>
SAE-10	<u>1</u>	<u>NONE</u>
SAE-30	<u>4</u>	<u>55</u>
GO-90	<u>1</u>	<u>NONE</u>
50 Wt Oil	<u>1</u>	<u>NONE</u>
Solvent	<u>3</u>	<u>NONE</u>
	<u>No. of 35 Lb Cans O/H</u>	<u>No. of Lbs Consumed</u>
GAA-3	<u>2</u>	<u>5</u>

Class IV

Sandbags	<u>0</u>	Qty O/H in Unit Supply Dump
Barbed Wire	<u>0</u>	-do-
Concertina	<u>0</u>	-do-
5' Fence Posts	<u>0</u>	-do-
32" Fence Posts	<u>0</u>	-do-
2' Fence Posts	<u>400</u>	-do-
8' Fence Posts	<u>0</u>	-do-

Class V - 1 DOA 3.5, 3 DOA 81mm, 1 DOA 106, and BA of all other.

(2) Problem Supply Items

See Encl (1) for Listing

c. Local Procurement  
N/A

d. Miscellaneous

(1) Captured Material: 5 Magazines, 2 M-1 Carbines, 11 Packs, and  
1 Basket

(2) Salvaged Material: None

3. Evacuation and Hospitalization

a. Evacuations

	<u>Number</u>	<u>Evacuated by</u>		<u>Awaiting</u>	<u>Returned</u>
		<u>Air</u>	<u>Surface</u>	<u>Evacuation</u>	<u>to Duty</u>
WIA	5	5		0	2
KIA	0				
Non-Battle	11		11	0	25

4. Transportation

a. Highway

(1) Availability

<u>Veh Type</u>	<u>T/E Shortages</u>	<u>Deadlined</u>	
		<u>Org</u>	<u>Field</u>
M-422	None	4	3
M-38A1			
M-274	3		19
M-35			
M-37			
M-51			
M-54			
M-52/M-172			
LVTP5			



(2) Utilization

	<u>Log Lift</u>	<u>Tact Lift</u>
Personnel	840	N/A
Cargo	6 Tons N/A CuFt	N/A Tons N/A CuFt
Total Mileage	4510	0

5. Service

a. Maintenance

	<u>D/L Start</u>	<u>No. Repaired During Period</u>		<u>D/L End of Period</u>	<u>Avail</u>
		<u>ORG</u>	<u>FLD</u>		
<u>Communications</u>					
PRC-6	9	11	4	6	34
PRC-10	9	10	0	14	22
PRC-41	1	0	1	0	3
PRC-47	0	0	0	1	4
PE -75	1	0	0	1	0
TPS-21	2	0	0	2	0
<u>Engineer</u>					
PU-348	1	(Code X)			
<u>Motor Transport</u>					
M-422	6	0	1	7	13
M-274	19	0	1	19	8
Lube Svc	1	0	0	1	0
<u>Ordnance</u>					
3.5	0	0	0	4	31
106	2	0	0	3	5
M-60	1	0	1	0	35
M-79	1	0	1	0	36
Flamethrower	4	0	3	1	7
81 (Sight)	1	0	0	1	7
<u>General Supply</u>					
					N/A

b. Construction

<u>Project</u>	<u>Date Started</u>	<u>Per cent Completed</u>	<u>Estimated Completion Date</u>
Command & CP Bunker	12 Jul	3	UNK
MLR	1 Jul	15	UNK
OPLR	1 Jul	60	UNK

6. Miscellaneous

a. Grid Coordinates of Headquarters: 564044

b. Protection Losses or damage due to:

- (1) Organized Enemy Action - None
- (2) Sabotage - None
- (3) Pilferage - None
- (4) Natural Causes - None
- (5) Measures Taken to reduce such losses - None

c. Projections Logistics requirements to support anticipated/planned operations.

- (1) Class IV requirements previously submitted will be needed to support establishment of new CP and battalion camp site vicinity of coordinates 532080.

d. Other Administrative Matters

- (1) One hundred ten General Purpose tents are still required to support planned cantonment.

BY COMMAND OF LIEUTENANT COLONEL J.E.MUIR

*H. T. Kerr*  
H. T. KERR  
Captain, U.S. Marine Corps  
S-4 Officer

DECLASSIFIED

Listing of Unfilled Priority 2  
and Certain Priority 5 Requisitions

Priority 2

Date	ASN	Item	Qty	Doc No.
22 May	6145 160 7795	Wire Mx306	20	04397
-do-	6145 243 8166	Wire RL159	15	04398
-do-	6140 981 5864	Battery Storage	15	04399
-do-	6140 981 5867	Connector	30	04400
-do-	5960 262 0167	Tube 12AT7WA	2	04401
29 May	5935 222 9914	Socket Electron	1	04410
-do-	5820 296 1443	Antenna AT 272	10	04415
-do-	5820 242 4967	Antenna AT 271	10	04416
-do-	5985 724 9514	Boat Antenna	1	04440
-do-	2530 724 3117	Master Cylinder	1	04441
-do-	2920 593 6436	Magneto Rpr Kit	2	04442
-do-	2610 569 0317	Tube 750x10	6	04443
-do-	2520 765 4799	CV Joint	3	04445
30 May	2990 630 5593	Hand Crank	10	04523
1 June	5930 548 6750	Cover Electric Switch	2	04550
5 June	2930 536 2798	Pulley Idler	1	04600
-do-	3030 691 3158	Belt V	1	04608
8 June	2530 724 3117	Master Cylinder	1	04623
10 Jun	3110 180 0534	Cup & Bearing	1	04633
-do-	2520 765 4799	CV Joint	1	04636
-do-	2510 726 7490	Spring Assembly	2	04637
-do-	2520 724 3070	Shaft Assembly	1	04638
-do-	2510 724 3066	Spring Assembly	2	04640
12 Jun	5310 045 1663	Nut Self Locking	8	04665
-do-	5340 727 5518	Bushing Rubber	8	04674
25 Jun	4730 011 2421	Fitting Copper	50	04742
-do-	4710 350 9886	Tubing Copper	25	04743
1 July	2320 064 6373	M-274 Mule	3	04779
5 July	5305 018 0021	Screw	80	00021
-do-	5310 012 0380	Lockwasher	1	00022
-do-	5305 088 5742	Bolt	40	00023
-do-	5310 012 0377	Nut	1	00024
-do-	2520 979 6549	Bracket	40	00025
-do-	2510 724 3066	Leaf Spring	3	00026
-do-	2510 726 7490	Leaf Spring	2	00027
-do-	2530 724 3117	Master Cylinder	2	00028

Priority 5

<del>03 Jun</del>	<del>6135 240 3200</del>	<del>BA 279</del>	<del>313</del>	<del>04755</del>
14 Jul	6135 240 3200	BA 279	200	00340
24 Jul	6135 240 3200	BA 279	600	00423
-do-	5960 188 6588	Tube 5672	2	00426
5 Aug	6115 682 3414	Gen PU-348	1	00621
8 Aug	6135 125 5256	Batt BA 414	72	00751

ENCLOSURE (1)

## AMMUNITION EXPENDITURE REPORT

<u>DOD</u>	<u>AMOUNT EXPENDED</u>
A 127	565 rds
A 130	1,940 rds
A 475	35 rds
B 568	67 rds
C 225	73 rds
C 226	2 rds
G 890	20 ea
G 895	9 ea
G 935	6 ea
G 940	6 ea
G 945	9 ea
G 950	4 ea
H 602	2 rds
H 030	2 rds
L 311	1 ea
L 312	4 ea
L 314	1 ea

DECLASSIFIED

Increase/Decrease to Equipment Density

<u>T/A No.</u>	<u>Old Totals</u>	<u>Increase</u>	<u>Decrease</u>	<u>New Total</u>
20930	1		1	0

Item Coded by FLSU # 1

ENCLOSURE (3)

DECLASSIFIED

3rd Battalion, 3rd Marines  
 Chu Lai, Viet Nam  
 191200 H August 1965

Periodic Logistics Report No. 12-65

Period Covered: 121200 H to 191200 H August 1965

Ref: (a) Map: Tri Binh 1:50,000 Sheet 6757-III  
 (b) CG msg 051244Z Jul 65  
 (c) CG msg 250234Z Jul 65

Encl: (1) Listing of unfilled Priority 2 and certain Priority 5 Requisitions.  
 (2) Ammunition expended during period.  
 (3) Increase/Decrease to equipment density.

1. Logistical Situation at end of period  
 CP Coord 564044

2. Supply

a. Supported Strength \*

	<u>Officer</u>	<u>Enlisted</u>	<u>Civilian</u>
U.S. Military	47	1060	
Allied Military	1	2	
V.C. Interned			
U.S. Civilians			
Allied Civilians			

b. Supply

(1) Unit Supplies

Class I

MCI	<u>3192</u>	No. of Meals
"B" Rations	<u>3</u>	No. of Days
"A" Rations	<u>1</u>	No. of Meals
Fuel Trioxane	<u>0</u>	No. of Bars or Tabs

\* These figures include all personnel eating in 3/3 messes.

Class II

Communications

Initial Allowance	<u>90</u>	% O/H
Repair Parts	<u>10</u>	No. of Days O/H
Consumables	<u>15</u>	No. of Days O/H

Engineer

Initial Allowance	<u>98</u>	% O/H
Repairs Parts	<u>0</u>	No. of Days O/H
Consumables	<u>0</u>	No. of Days O/H

General Supply

Initial Allowance	<u>80</u>	% O/H
Repair Parts	<u>60</u>	No. of Days O/H
Consumables	<u>20</u>	No. of Days O/H

Motor Transport

Initial Allowance	<u>89</u>	% O/H
Repair Parts	<u>8</u>	No. of Days O/H
Consumables	<u>8</u>	No. of Days O/H

Ordnance

Initial Allowance	<u>90</u>	% O/H
Repair Parts	<u>10</u>	No. of Days O/H
Consumables	<u>0</u>	No. of Days O/H

Class III

	<u>0</u>	No. of Gallons MOGAS
Bulk		
Drummed	No. of Drums O/H	No. of Gallons Consumed
MOGAS	<u>6</u>	<u>1500</u>
DIESEL	<u>2</u>	<u>20</u>
KEROSENE	<u>0</u>	<u>20</u>
SAE 10	<u>1</u>	<u>0</u>
SAE 30	<u>3</u>	<u>20</u>
GO -90	<u>1</u>	<u>5</u>
50 Wt Oil	<u>1</u>	<u>0</u>
SOLVENT	<u>1</u>	<u>1</u>
	<u>No. of Cans O/H</u>	<u>No. of Lbs Consumed</u>
GAA-3	<u>2</u>	<u>10</u>

Class IV

Sandbags	<u>0</u>	O/H in Unit Supply
Barbed Wire	<u>0</u>	-do-
Concertina	<u>0</u>	-do-
5' Fence Post	<u>0</u>	-do-
2' Fence Post	<u>400</u>	-do-
8' Fence Post	<u>0</u>	-do-
32" Fence Post	<u>0</u>	-do-

Class V - 1 DOA 3.5, 1 DOA 81, 1 DOA 106, and BA of all other.

(2) Problem Supply Items - See Encl (1) for Listing

c. Local Procurement - N/A

d. Miscellaneous

- (1) Captured Material: 2 Russian Carbines, 2 BARs, 11 M-1s, 2 Carbines, 4 M-14s, 1 M-79, 1 45 Cal pistol, 1 Sten Gun, 22 Grenades, 12 M-79 Rds, 1 Chinese Mine, 1 Chinese modified sub-machine gun.
- (2) Salvaged Material: None

3. Evacuation and Hospitalization

a. Evacuations

	Number	Evacuated By		Awaiting Evacuation	Return To Duty
		Air	Surface		
WIA	92	73	0	0	19
KIA	29	19	0	0	0
Non-Battle	12	4	8	0	5

4. Transportation

c. Highway

(1) Availability

Veh Type	T/E Shortages	Deedlined	
		Org	Field
M-422	None	3	3
M-274	4		19



(2) Utilization

Personnel	Log Lift 983	Tact Lift N/A
Cargo	1 Tons N/ACuFt	N/A Tons N/ACuFt
Total Mileage	2247	0

5. Service

a. Maintenance

	D/L Start	No. Repaired During Period ORG FLD	D/L End of Period	Avail
<b>Communications</b>				
PRC-6	6	1	12	22
PRC-10	14		8	31
PRC-47	1	1	0	5
TPS-21	2	2	0	2
<b>Engineer</b>				
PE-75	1		1	0
<b>Motor Transport</b>				
M-422	7	3	6	14
M-274	19		19	7
Lube Svc	1		1	0
<b>Ordnance</b>				
3.5	4	2	2	33
106	3		3	5
M-60			1	34
M-79			1	35
Flamethrower	1		1	7
81mm(Sight)	1		1	7
General Supply				
N/A				

b. Construction

Project	Date Started	Per cent Completed	Estimated Completion Date
New CP Site	16Aug	5	UNK

6. Miscellaneous

a. Grid Coordinates of Headquarters: 564044

b. Protection Losses or damage due to:

- (1) Organized Enemy Action - Information incomplete, will include on next report.
- (2) Sabotage - None
- (3) Pilferage - None
- (4) Natural Causes - None
- (5) Measures taken to reduce such losses - None

c. Projections Logistics requirements to support anticipated/planned operations.

- (1) Class IV requirements previously submitted will be needed to support establishment of new CP and Battalion Camp site vicinity of coordinates 528023

d. Other Administrative Matters

- (1) One hundred ten General Purpose tents are still required to support planned cantonment.

BY COMMAND OF LIEUTENANT COLONEL J.E. MUIR

*H. T. Kerr*  
H. T. KERR  
Captain, U.S. Marine Corps  
S-4 Officer

DECLASSIFIED

Listing of Unfilled Priority 2  
and Certain Priority 5 Requirements

Priority 2

Date	ASN	Item	Qty	Doc. No.
22 May	6145 160 7795	Wire 24706	20	04397
-do-	6145 243 8466	Wire 24709	15	04398
-do-	6140 981 5565	Battery Storage	15	04399
-do-	6140 981 5867	Converter	30	04400
-do-	5960 262 0167	Tube 12AT7WA	2	04401
29 May	5935 222 9914	Socket Electron	1	04410
-do-	5820 296 1443	Antenna AT 272	10	04415
-do-	5820 242 4967	Antenna AT 271	10	04415
-do-	5985 724 9514	Boot Antenna	1	04440
-do-	2530 724 3117	Master Cylinder	1	04441
-do-	2920 593 6436	Magneto Rpr Kit	2	04442
-do-	2610 569 0817	Tube 750x10	6	04443
-do-	2520 765 4799	CV Joint	3	04445
30 May	2920 630 5593	Hand Crank	10	04523
1 June	5930 540 6750	Cover Electric Switch	2	04550
5 June	2920 536 2798	Pulley Idler	1	04600
-do-	3030 698 3158	Belt V	1	04608
8 June	2530 724 3117	Master Cylinder	1	04623
10 June	3110 100 0534	Cup & Bearing	1	04633
-do-	2520 765 4799	CV Joint	1	04636
-do-	2510 726 7490	Spring Assembly	2	04637
-do-	2520 724 3070	Shaft Assembly	1	04638
-do-	2510 724 3066	Spring Assembly	2	04640
12 June	5310 045 1063	Nut Self Locking	8	04665
-do-	5340 727 5568	Bushing Rubber	8	04674
25 June	4730 014 2431	Fitting Copper	50	04742
-do-	4710 350 9886	Tubing Copper	25	04743
1 July	2320 064 5373	M-274 Male	3	04779
5 July	5305 018 0021	Screw	80	00021
-do-	5306 088 5742	Bolt	40	00023
-do-	5310 012 0377	Nut	1	00024
-do-	2520 979 6549	Bracket	40	00025
-do-	2510 724 3066	Leaf Spring	3	00026
-do-	2510 726 7490	Leaf Spring	2	00027
5 Aug	6115 682 3414	Gen PU 348	1	00621
		Priority 5		
14 June	6135 240 3200	BA 279	200	00340
24 July	5960 188 6588	Tube 5672	2	00426
0 Aug	6135 125 5256	Brett BA 414	72	00751

ENCLOSURE (1)

DECLASSIFIED

DECLASSIFIED

AMMUNITION EXPENDITURE REPORT

<u>DOD NO.</u>	<u>AMOUNT EXPENDED</u>
A 127	8,785
A 130	9,193
A 475	186
B 568	238
C 222	3
C 225	252
C 226	58
C 230	16
G 890	94
G 895	8
G 940	14
G 945	17
H 600	26
H 602	21
L 312	7
L 324	1
M 756	31

ENCLOSURE (2)

DECLASSIFIED

## Increase/Decrease in Equipment Density

<u>T/A No.</u>	<u>Old Totals</u>	<u>Increase</u>	<u>Decrease</u>	<u>New Totals</u>
51410	27		1	26
61380	884		1	883
61170	302		3	299
22060	36		2	34
22100	40		1	39

Coded at FISU

ENCLOSURE (3)

3rd Battalion, 3rd Marines  
 Chu Lai, West Nam  
 261200 H August 1965

Periodic Logistic Report No. 13-65

Period Covered: 191200 H to 261200 H August 1965

- Rcf: (a) Map: Tri Binh 1:50,000 Sheet 6757-III  
 (b) CG msg 051244Z July 65  
 (c) CG msg 250234Z July 65

- Encl: (1) Listing of unfilled Priority 2 and certain Priority 5 Requisitions  
 (2) Ammunition expended during period  
 (3) Increase/Decrease to Equipment Density

1. Logistical Situation at end of Period

CP Coord 564044

2. Supply

a. Supported strength \*

	<u>Officer</u>	<u>Enlisted</u>	<u>Civilian</u>
U.S. Military	41	931	
Allied Military	1	2	
V.C. Interned			
U.S. Civilians			
Allied Civilians			

b. Supply

(1) Unit Supplies

Class I

MCI	2208	No. of Meals
"B" Rations	4	No. of Days
"A" Rations	1	No. of Meals
Fuel Trioxane	0	No. of Tabs or Bars

\* These figures include all personnel eating in 3/3 messes.

Class II

Communications

Initial Allowance	90	% O/H
Repair Parts	10	No. of Days O/H
Consumables	15	No. of Days O/H

Engineer

Initial Allowance	75	% O/H
Repair Parts	0	No. of Days O/H
Consumables	0	No. of Days O/H

Class II (Cont)

General Supply  
Initial Allowance  
Repair Parts  
Consumables

80 % O/H  
60 No. of Days O/H  
18 No. of Days O/H

Motor Transport  
Initial Allowance  
Repair Parts  
Consumables

89 % O/H  
2 No. of Days O/H  
2 No. of Days O/H

Ordnance  
Initial Allowance  
Repair Parts  
Consumables

90 % O/H  
10 No. of Days O/H  
0 No. of Days O/H

Class III

	<u>0</u> No. of Gallons MOGAS	
	<u>No. of Drums O/H</u>	<u>No. of Gallons Consumed</u>
Bulk	<u>0</u>	
Drummed		
MOGAS	<u>8</u>	<u>1,815</u>
DIESEL	<u>1</u>	<u>55</u>
KEROSENE	<u>0</u>	<u>0</u>
SAE 10	<u>1</u>	<u>0</u>
SAE 30	<u>3</u>	<u>55</u>
GO -90	<u>1</u>	<u>0</u>
50 wt Oil	<u>1</u>	<u>0</u>
SOLVENT	<u>0</u>	<u>55</u>
	<u>No. of Cans O/H</u>	<u>No. of Lbs Consumed</u>
GAA-3	<u>1</u>	<u>35</u>

Class IV

	<u>0</u> O/H in Unit Supply	
Sandbags	<u>0</u>	-do-
Barbed Wire	<u>0</u>	-do-
Concertina	<u>0</u>	-do-
5' Fence Post	<u>0</u>	-do-
2' Fence Post	<u>400</u>	-do-
8' Fence Post	<u>0</u>	-do-
32" Fence Post	<u>0</u>	-do-

Class V - 1 DOA 3.5, 3 DOA 81, 1 DOA 106, and BA of all other.

(2) Problem Supply Items

See Enclosure (1) for Listing

c. Local Procurement - N/A

d. Miscellaneous

(1) Captured Material: 1 M-14 and 2 Carbines

(2) Salvaged Material: None

3. Evacuation and Hospitalization

a. Evacuations

	<u>Number</u>	<u>Evacuated by</u>		<u>Awaiting Evacuation</u>	<u>Returned to Duty</u>
		<u>Air</u>	<u>Surface</u>		
WIA	36	11			25
KIA	2	2			
Not Battle	5	4			1

4. Transportation

a. Highway

(1) Availability

<u>Veh Type</u>	<u>T/E Shortages</u>	<u>Deadlined</u>	
		<u>Org</u>	<u>Field</u>
M-422	None	3	3
M-274	4		20
Lube Svc Unit	None		1

(2) Utilization

	<u>Log Lift</u>	<u>Test Lift</u>
Personnel	983	N/A
Cargo	1 Tons N/A CuFt	N/A Tons N/A CuFt
Total Mileage	2247	0

5. Service

a. Maintenance

	<u>D/L Start</u>	<u>No. Repaired During Period</u>		<u>D/L End of Period</u>	<u>Avail</u>
		<u>ORG</u>	<u>FLD</u>		
<u>Communications</u>					
PRC-6	12			12	22
PRC-10	8		3	6	33
PRC-47	0			1	4
PRC-41	0			1	2
<u>Engineer</u>					
PE-75	1			1	0
<u>Motor Transport</u>					
M-422	6		1	6	14
M-274	19			20	6
Lube Svc	1			1	0
<u>Ordnance</u>					
3.5	2			3	29
106	3			3	5
M-60	1			2	33
M-79	1			1	35
Flamethrower	1			1	7
81mm	1			2	6



General Supply - N/A

b. Construction

<u>Project</u>	<u>Date Started</u>	<u>Per cent Completed</u>	<u>Estimated Completion Date</u>
New CP Site	16Aug	25	UNK

Construction of new MLR to commence upon displacement of CP.

c. Miscellaneous

a. Grid Coordinates of Headquarters: 564044

b. Protection: Losses or damage due to:

(1) Organized Enemy Action - 13 Rifles and 2 Pistols of casualties are missing and presumed lost in the area of operation Starlite or in the casualty evacuation chain. Searches and liaison are still being effected in an attempt to recover these weapons.

(2) Sabotage - None

(3) Pilferage - None

(4) Natural Causes - None

(5) Measures taken to reduce such losses - Indoctrination of personnel handling casualties to tag and promptly evacuate weapons with the casualty.

c. Projections: Logistics requirements to support anticipated/planned operations.

(1) Class IV requirements previously submitted will be needed to support establishment of new CP and Battalion Camp site vicinity of coordinates 528023.

d. Other Administrative Matters

(1) One hundred ten General Purpose tents are still required to support planned cantonment.

BY COMMAND OF LIEUTENANT COLONEL J.E. MUIR

*H. T. Kerr*  
 H. T. KERR  
 Captain, U.S. Marine Corps  
 S-4 Officer

Listing of Unfilled Priority 2  
and General Priority 5 Requisitions

## Priority 2

<u>Date</u>	<u>FSN</u>	<u>Item</u>	<u>Qty</u>	<u>Doc. No.</u>
22 May	6145 160 7795	Wire MX306	20	04397
-do-	6145 243 8466	Wire RL159	15	04398
-do-	6140 981 5865	Battery Storage	15	04399
-do-	6140 981 5867	Connector	30	04400
-do-	5960 262 0167	Tube 12AT7WA	2	04401
29 May	5935 222 9914	Socket Electron	1	04410
-do-	5820 296 1443	Antenna AT 272	10	04415
-do-	5820 242 4967	Antenna AT 271	10	04416
-do-	5985 724 9514	Boat Antenna	1	04440
-do-	2530 724 3117	Master Cylinder	1	04441
-do-	2920 593 6436	Magneto Rpr Kit	2	04442
-do-	2610 569 0817	Tube 750x10	6	04443
-do-	2520 765 4799	CV Joint	3	04445
30 May	2990 630 5593	Hand Crank	10	04523
1 June	5930 548 6750	Cover Electric Switch	2	04550
5 June	2930 536 2798	Pulley Idler	1	04600
-do-	3030 698 3158	Belt V	1	04608
8 June	2530 724 3117	Master Cylinder	1	04623
10 June	3110 100 0534	Cup & Bearing	1	04633
-do-	2520 765 4799	CV Joint	1	04636
-do-	2514 726 7490	Spring Assembly	2	04637
-do-	2520 724 3070	Shaft Assembly	1	04638
-do-	2510 724 3066	Spring Assembly	2	04640
12 June	5310 045 1063	Nut Self Locking	8	04665
-do-	5340 727 5568	Bushing Rubber	8	04674
25 June	4730 014 2431	Fitting Copper	50	04742
-do-	4710 350 9886	Tubing Copper	25	04743
1 July	2320 064 5373	M-274 Male	3	04779
5 July	5305 018 0021	Screw	80	00021
-do-	5306 088 5742	Bolt	40	00023
-do-	5310 012 0377	Nut	1	00024
-do-	2520 979 6549	Bracket	40	00025
-do-	2510 724 3066	Leaf Spring	3	00026
-do-	2510 726 7490	Leaf Spring	2	00027
5 Aug	6115 682 3414	Gen PU 348	1	00621
		Priority 5		
14 June	6135 240 3200	BA 279	200	00340
24 July	5960 188 6588	Tube 5672	2	00426
8 Aug	6135 125 5256	Batt BA 314	72	00751

ENCLOSURE (1)

DECLASSIFIED

AMMUNITION EXPENDITURE REPORT

<u>DOD</u>	<u>AMOUNT EXPENDED</u>
A 127	10,640
A 130	10,210
A 475	180
B 568	238
C 226	69
G 890	93
G 895	15
G 935	5
G 945	12
H 600	22
H 602	23
G 030	4
L 312	35
L 314	2

DECLASSIFIED

Increase Decrease to Equipment Density

T/A No.	Old Totals	Increase	Decrease	New Total
---------	------------	----------	----------	-----------

No Change

ENCLOSURE (3)

DECLASSIFIED